

MODEL *for*
DESIGN
MANUAL

LIVING STREETS

Los Angeles County

2011



ATTRIBUTION STATEMENT

This manual is made possible by funding from the Department of Health and Human Services through the Los Angeles County Department of Public Health.

The sponsors include the following groups:



UCLA Luskin School *of* Public Affairs

Luskin Center for Innovation

With support from:

UCLA Luskin School *of* Public Affairs

Lewis Center

UCLA Luskin School *of* Public Affairs

Institute of Transportation Studies

Creation of the manual was managed by:



transportation planning for livable communities

This page left intentionally blank

TABLE OF CONTENTS

Right to Use the Manual.....	i
Acknowledgements.....	ii

CHAPTER 1. INTRODUCTION

CONTEXT.....	1-2
LEGAL STANDING OF STREET MANUALS.....	1-3
AASHTO Green Book.....	1-3
California Highway Design Manual.....	1-4
Local Street Manuals.....	1-4
MUTCD.....	1-7
California Fire Code.....	1-8
California Streets and Highways Code and California Vehicle Code.....	1-9
PURPOSE OF THE MANUAL.....	1-10
HOW TO USE THE MANUAL.....	1-12
ADOPTION AND IMPLEMENTATION.....	1-13
HOW THIS MANUAL WAS CREATED.....	1-14

CHAPTER 2. VISION, GOALS, POLICIES, AND BENCHMARKS

INTRODUCTION.....	2-2
VISION.....	2-2
GOALS.....	2-3
POLICIES.....	2-4
CREATING A NEW SET OF BENCHMARKS AND PERFORMANCE	
MEASURES.....	2-7
Benchmarks.....	2-8
Performance Measures.....	2-8

CHAPTER 3. STREET NETWORKS AND CLASSIFICATIONS

INTRODUCTION..... 3-2
ESSENTIAL PRINCIPLES OF SUSTAINABLE STREET NETWORKS..... 3-4
STREET CHARACTERISTICS AND CLASSIFICATIONS..... 3-4
 Context: The Transect..... 3-6
DESIGN STANDARDS..... 3-7
 Types and Roles of Streets..... 3-8

CHAPTER 4. TRAVELED WAY DESIGN

INTRODUCTION..... 4-2
ESSENTIAL PRINCIPLES OF TRAVELED WAY DESIGN..... 4-3
FACTORS AFFECTING STREET DESIGN..... 4-4
 Users..... 4-4
 Traffic Volume and Composition..... 4-6
 Design Speed..... 4-7
 Multi-Modal Level of Service..... 4-9
 Access Management..... 4-12
CROSS SECTIONAL ELEMENTS..... 4-14
 On-Street Parking..... 4-14
 Bicycle Facilities..... 4-16
 Transit Facilities..... 4-16
 Travel Lanes..... 4-16
 Medians..... 4-18
 Sample Cross Sections..... 4-20
OTHER GEOMETRIC DESIGN ELEMENTS..... 4-27
 Vertical Alignment..... 4-27
 Horizontal Alignment..... 4-27
 Sight Distance..... 4-27
 Horizontal Clearance/Clear Zone..... 4-28
 Traveled Way Lighting..... 4-29
MODEL PROJECT..... 4-30
 La Jolla..... 4-30

CHAPTER 5. INTERSECTION DESIGN

INTRODUCTION.....	5-2
ESSENTIAL PRINCIPLES OF INTERSECTION DESIGN.....	5-2
INTERSECTION GEOMETRY.....	5-3
Intersection Skew.....	5-3
Corner Radii.....	5-5
Curb Extensions.....	5-6
Crosswalk and Ramp Placement.....	5-8
On-Street Parking Near Intersections.....	5-10
Right Turn Channelization Islands.....	5-10
YIELD AND STOP CONTROLLED INTERSECTIONS.....	5-12
SIGNALIZED INTERSECTIONS.....	5-13
Operational Design.....	5-14
Phasing.....	5-14
ROUNDBABOUTS.....	5-19
Advantages and Disadvantages.....	5-20
General Design Elements of Roundabouts.....	5-22
Roundabout Design Criteria.....	5-23
Operations and Analysis.....	5-24
Single-Lane Roundabouts.....	5-24
Multi-Lane Roundabouts.....	5-25
Mini-Roundabouts.....	5-27
Neighborhood Traffic Circles.....	5-28

CHAPTER 6. UNIVERSAL PEDESTRIAN ACCESS

INTRODUCTION.....	6-2
ESSENTIAL PRINCIPLES OF UNIVERSAL PEDESTRIAN ACCESS.....	6-3
LEGAL FRAMEWORK.....	6-3
USERS AND NEEDS.....	6-5
People with Mobility Impairments.....	6-5
People with Visual Impairments.....	6-6
People with Cognitive Impairments.....	6-7

Children and Older Adults.....	6-7
PEDESTRIAN FACILITY DESIGN.....	6-8
Sidewalks.....	6-8
Curb Ramps.....	6-11
Detectable Warnings.....	6-16
Signals.....	6-17
LAND USE AND SIDEWALK DESIGN GUIDELINES.....	6-19
Low / Medium Density Residential.....	6-20
Medium / High Density Residential.....	6-20
Neighborhood Commercial.....	6-21
General / Regional Commercial.....	6-21
Mixed / Multi-Use.....	6-22
Industrial.....	6-22
Downtown Core/Main Street.....	6-23
Office Park.....	6-23
Public Facilities.....	6-24
DESIGN SPECIFICATIONS BY ROADWAY TYPE AND LAND USE.....	6-24
General Guidelines.....	6-27
FOR MORE INFORMATION.....	6-27

CHAPTER 7. PEDESTRIAN CROSSINGS

INTRODUCTION.....	7-2
ESSENTIAL PRINCIPLES OF PEDESTRIAN CROSSINGS.....	7-3
PERFORMANCE MEASURES.....	7-5
PEDESTRIAN CROSSING TOOLBOX.....	7-5
Marked Crosswalks.....	7-6
Raised Crossing Islands/Medians.....	7-9
Raised Crosswalks.....	7-12
Curb Extensions.....	7-12
Pedestrian 'Scrambles'.....	7-14
Signs.....	7-15

Advanced Yield/Stop Lines.....	7-16
Lighting.....	7-16
Pedestrian Hybrid Beacon.....	7-18
Rectangular Rapid Flash Beacon (RRFB).....	7-18
Pedestrian Toolbox for Railroad Crossings.....	7-19

CHAPTER 8. BIKEWAY DESIGN

ESSENTIAL PRINCIPLES OF BIKEWAY DESIGN.....	8-2
PLANNING FOR A RANGE OF BIKEWAY USERS.....	8-2
BIKEWAY TYPES.....	8-4
Shared Roadways.....	8-5
Bicycle Boulevards.....	8-5
Shoulder Bikeways.....	8-6
Bike Lanes.....	8-6
Cycle Tracks.....	8-6
Shared Use Paths.....	8-6
Bike Routes.....	8-7
INTEGRATING WITH THE STREET SYSTEM.....	8-7
DESIGN OF EACH BIKEWAY TYPE.....	8-9
Shared Roadways.....	8-9
Bicycle Boulevards.....	8-11
Shoulder Bikeways.....	8-13
Bike Lanes.....	8-14
Cycle Tracks.....	8-17
Shared Use Paths.....	8-18
INTERSECTIONS.....	8-19
Bikeway Markings at Intersections.....	8-19
Bike Signal Heads.....	8-20
Bicycle Signal Detection.....	8-21
Bike Boxes.....	8-21
Bicycle Countdowns.....	8-22

Leading Bicycle Intervals.....	8-22
Two-Stage Turn Queue Boxes.....	8-22
Colored Pavement Treatments.....	8-22
Wayfinding.....	8-23
Bicycle Parking.....	8-24
Maintenance.....	8-24
IMPLEMENTATION.....	8-26
Resurfacing.....	8-26
Utility Work.....	8-27
Redevelopment.....	8-27
Paved Shoulders.....	8-28
ADDITIONAL RESOURCES.....	8-28

CHAPTER 9. TRANSIT ACCOMMODATIONS

INTRODUCTION.....	9-2
ESSENTIAL PRINCIPLES OF DESIGNING STREETS FOR TRANSIT.....	9-2
ACCESS TO TRANSIT.....	9-4
BUS STOPS.....	9-4
Layout.....	9-4
Transit-Specific Streetscape Elements.....	9-5
BUS STOP PLACEMENT.....	9-7
SIGNAL TREATMENT.....	9-9
BUS BULBS.....	9-10
Characteristics.....	9-11
URBAN DESIGN.....	9-12
BICYCLE CONNECTIONS.....	9-13
BUS LANES.....	9-13
ACCOMODATING LIGHT RAIL, STREET CARS, AND BRT.....	9-14

CHAPTER 10. TRAFFIC CALMING

DEFINITION..... 10-2

CATEGORIES..... 10-4

SAFETY..... 10-5

EMERGENCY RESPONSE AND NUMBER OF PERIODIC MEASURES..... 10-7

 Exceptions..... 10-8

 Design Vehicle..... 10-8

GENERAL POLICY GUIDANCE..... 10-9

 Tort Liability..... 10-9

 Traffic Calming Contexts..... 10-10

 Planning and Design Processes..... 10-15

CHAPTER 11. STREETScape ECOSYSTEM

INTRODUCTION..... 11-2

PRINCIPLES OF STREETScape ECOSYSTEM DESIGN..... 11-2

STREETWATER MANAGEMENT..... 11-3

 Goals and Benefits of Streetwater Management..... 11-5

 Principles of Streetwater Management..... 11-6

 Definitions..... 11-7

 Tools for Streetwater Management..... 11-9

URBAN FORESTRY..... 11-31

 Street Trees..... 11-32

 Understory Landscaping..... 11-39

STREET FURNITURE..... 11-42

 Benches and Seating..... 11-44

 Bollards..... 11-45

 Street Vendor Stands..... 11-46

 Informational Kiosks..... 11-46

 News Racks..... 11-47

 Parking Meters..... 11-48

 Signs..... 11-49

Refuse Receptacles.....	11-49
Public Art.....	11-50
Sidewalk Dining.....	11-51
Other Streetscape Features.....	11-52
UTILITIES.....	11-52
Guidelines.....	11-53
Lighting.....	11-58
ADDITIONAL SELECT RESOURCES.....	11-60

CHAPTER 12. RE-PLACING STREETS: PUTTING THE PLACE BACK IN STREETS

INTRODUCTION.....	12-2
PUBLIC SPACE AND THE NEED TO RE-PLACE STREETS.....	12-3
PLACEMAKING FOR STREETS.....	12-4
Design Techniques and Goals for Replaced Streets.....	12-5
STRATEGIES TO RE-PLACE STREETS.....	12-10
The Street’s Place in the Community.....	12-10
Placemaking Participants.....	12-10
The Placemaking Process.....	12-11

CHAPTER 13. DESIGNING LAND USE ALONG LIVING STREETS

- INTRODUCTION..... 13-2
- ESSENTIAL PRINCIPLES FOR BALANCED STREET ENVIRONMENTS..... 13-3
- STREETScape ENVIRONMENT TYPES..... 13-5
 - Neighborhoods..... 13-5
 - Neighborhood Centers..... 13-7
 - Corridors..... 13-9
 - Urban Centers..... 13-11
 - Special Use Districts..... 13-13
 - Urban Design..... 13-15
 - Thoughtful Site Design..... 13-17
 - Buildings’ Relationship to Sidewalk..... 13-18
 - Appropriate Building Forms..... 13-19
- POTENTIAL IMPLEMENTATION STRATEGIES..... 13-22
- HEALTH AND LAND USE..... 13-24

CHAPTER 14. RETROFITTING SUBURBIA

- INTRODUCTION..... 14-2
- TRANSFORMING SUBURBAN STREETS TO LIVING STREETS..... 14-3
 - Changing Streets without Changing the Right-of-Way..... 14-4
 - Non-Physical Changes..... 14-6
 - Street Crossings..... 14-6
- RE-ESTABLISHING STREET NETWORKS..... 14-7
- SECOND-GENERATION LAND USE ALONG TRANSFORMED STREETS..... 14-7
- SETTING PRIORITIES AND PHASING..... 14-10
- MODEL PROJECT: BRIDEPORT WAY..... 14-12
- ADDITIONAL RESOURCES..... 14-14

CHAPTER 15. COMMUNITY ENGAGEMENT FOR STREET DESIGN

INTRODUCTION..... 15-2

ESSENTIAL PRINCIPLES OF COMMUNITY ENGAGEMENT..... 15-4

 Develop a Plan..... 15-4

 Accept Responsibility for Success..... 15-5

 Start with a Base of Shared Values and Build Understanding..... 15-7

 Broaden the List of Stakeholders..... 15-11

 Foster Cultural Competence..... 15-15

 Expect Emotional Connections—and Reactions—to the Built Environment..... 15-16

 Approach Engagement as a Two-Way Conversation..... 15-17

 Achieving Informed Consent..... 15-18

 Carry the Momentum Forward..... 15-20

CONCLUSION..... 15-22

ADDITIONAL RESOURCES..... 15-23

APPENDIX: VISIONS OF TRANSFORMING STREETS

RIGHT TO USE THE MANUAL

The Los Angeles County Model Design Manual for Living Streets is available for any jurisdiction to use. Jurisdictions may adopt, customize, or modify the manual to meet their needs. The manual's sponsors ask only two things:

1. That jurisdictions maintain the acknowledgements to credit the individuals who worked so hard to produce the manual
2. That they notify the manual's website (www.modelstreetdesignmanual.com) to allow the sponsors to track which communities have adopted the manual at least in substantial part

Thank you.

ACKNOWLEDGMENTS

Suzanne Bogert, Director of RENEW, Los Angeles County Department of Public Health.

Ryan Snyder, President of Ryan Snyder Associates, Federal Highway Administration Pedestrian Safety Design Instructor, Complete Streets Instructor, National Safe Routes to School Instructor. National Sustainable Building Program Instructor. UCLA Urban Planning Instructor. Coordinated street manual project, worked on all chapters, and contributed many of the photos.

Colleen Callahan, Deputy Director of the UCLA Luskin Center for Innovation. Managed Chapter 11.

Michael Ronkin, Owner, Designing Streets for People LLC. Complete Streets Instructor, Federal Highway Administration Pedestrian Safety Design Instructor. Provided content editing for entire manual.

Jean Armbruster, Director of the Policies for Livable, Active Communities and Environments (PLACE) program for the Los Angeles County Department of Public Health. Contributed to Chapter 6.

Edward Belden, LEED-AP. Senior Scientist at the Council for Watershed Health. Contributed to Chapter 11.

Pippa Brashear, Project Manager at Project for Public Spaces. Contributed to Chapter 12.

Madeline Brozen, Complete Streets Director, UCLA Luskin Center for Innovation. Contributed to Chapter 2.

Marty Bruinsma, Graphic Designer and Artist. Illustrated numerous graphics throughout this manual.

Dan Burden, Executive Director of the Walkable and Livable Communities Institute, internationally recognized authority on bicycle and pedestrian facilities and creating livable communities. Contributed to all chapters and contributed many of the pictures.

Julia Campbell, LEED AP, EIT. Master of Urban and Regional Planning student at the UCLA Luskin School of Public Affairs; graduate student researcher for the UCLA Luskin Center for Innovation and formerly a hydraulic engineer focusing on stormwater management. Contributed to and edited Chapter 11.

Lisa Cirill, M.S., P.A.P.H.S. Chief of California Active Communities, a joint unit of the California Department of Health and the University of California, San Francisco. Contributed to Chapter 2.

Art Cueto, Planning Manager at Transtech. Contributed to Chapter 9.

J.R. DeShazo, Director of the UCLA Luskin Center for Innovation. Contributed to Chapter 11.

Peter Eun, Member, Federal Highway Administration Resource Center Safety and Design Team. Federal Highway Administration Pedestrian Safety Design Instructor. Contributed to Chapter 7.

Charlie Gandy, Mobility Coordinator for the City of Long Beach, California. Contributed to Chapter 2.

Norman Garrick, Ph.D. Associate Professor at the University of Connecticut in the Department of Civil and Environmental Engineering. Board member of the Congress for New Urbanism. Contributed to Chapter 3.

Said Gharbieh, BSc, MSc, FCIHT, FCIT, MBIM. Principal at Arup. Leads Arup's transportation planning business in Southern California. Contributed to Chapter 3.

Ellen Greenberg, PE. Associate Principal at Arup; heads the Integrated Planning department. A lead author of Context Sensitive Design Solutions for Major Urban Thoroughfares for Walkable Communities. Contributed to Chapter 3.

Gayle Haberman, Policy Analyst of the Policies for Livable, Active Communities and Environments (PLACE) program for the Los Angeles County Department of Public Health. Contributed to Chapter 2.

Andre Haghverdian, PE. President of Pivot Group, Inc., a civil engineering and construction firm. Contributed to Chapter 11.

Holly Harper, Architect and Initiative Coordinator for Calles Para la Gente Boyle Heights. Contributed to Chapter 11.

Billy Hattaway, Managing Director of Transportation, Florida with VHB Miller Sellen. Author of the new “Traditional Neighborhood Development” chapter of the Florida GreenBook. Contributed to Chapters 4 and 5.

Brett Hondorp, AICP. Vice President, Association of Pedestrian and Bicycle Professionals. Principal with Alta Planning + Design. Contributed to Chapter 8.

Julia Lave Johnston, Director of the Land Use and Natural Resources Program at the University of California, Davis, Extension. Formerly Deputy Director for Planning Policy in the California Governor’s Office of Planning and Research. Contributed to Chapter 2.

Peter Lagerwey, Senior Planner and Regional Office Director for Toole Design Group in Seattle, Washington. Federal Highway Administration Pedestrian Safety Design Instructor, Complete Streets Instructor, National Safe Routes to School Instructor. Contributed to Chapter 7.

Brad Lancaster, Author of Rainwater Harvesting for Drylands and Beyond. Conducts permaculture consulting, design, and education. Contributed to Chapter 11.

Stephanie Landregan, FASLA, LEED-AP. Director for the Landscape Architecture Program at UCLA Extension. City of Glendale Planning Commissioner. Contributed to Chapter 11.

Ian Lockwood, PE, Loeb Fellow. Principal at AECOM. Widely recognized as one of the leading traffic engineers in North America. Contributed to Chapters 3, 10, and 15.

Jana Lynott, AICP. Senior Strategic Policy Advisor for Transportation and Livable Communities at the Public Policy Institute of AARP. Author of Planning Complete Streets for an Aging America. Contributed to Chapters 6 and 13.

Mukul Malhotra, Principal at MIG, Inc. Coordinator of 2011 Streets Project Conference in Berkeley, California. Contributed to Chapters 4 and 5.

Tim Mann, RLA. Principal at Lynn Capouya, Inc. Landscape Architects. Contributed to Chapter 11.

Barbara McCann, Executive Director of the National Complete Streets Coalition. Contributed to Chapter 2.

Cullen McCormick, UCLA Urban Planning Masters Student. Contributed to manual design.

Jessica Meaney, California Policy Manager for the Safe Routes to School National Partnership. National Safe Routes to School Instructor. Contributed to Chapter 2.

Lys Mendez, master's student of urban planning at UCLA. Contributed preliminary editing.

Rock Miller, PE. President-elect of the Institute of Transportation Engineers. Principal at Stantec. Contributed to Chapters 1, 4, 5, and 8.

Kelly Morphy, Director of Outreach and Communications, Walkable and Livable Communities Institute. Contributed to Chapter 15.

Michael Moule, PE, TE, PTOE. Principal at Nelson\Nygaard Consulting Associates. Past president of the Association of Pedestrian and Bicycle Professionals. Co-author of the 2011 AASHTO Bike Guide, co-author of Roundabouts: An Informational Guide, 2010. Federal Highway Administration Pedestrian Safety Design Instructor, Complete Streets Instructor, Contributed to Chapters 4, 5, and 8.

Deborah Murphy, Associate AIA. Principal of Deborah Murphy Urban Design + Planning and Founder of Los Angeles Walks. Contributed to Chapter 11.

Narasimha Murthy, Ph.D., TE. President of Murthy Transportation Consultants. Contributed to Chapters 4 and 5.

Margot Ocañas, Policy Analyst with the Renewing Environments for Nutrition, Exercise, and Wellness (RENEW) program for the Los Angeles County Department of Public Health. Assisted on several chapters.

Lisa Padilla, AIA, LEED-AP. Architect and Urban Designer. Principal of Cityworks Design. Contributed to Chapter 13.

Simon Pastucha, Chief Urban Designer for the City of Los Angeles. Contributed to Chapters 13 and 15.

Jen Petersen, Ph.D. Urban sociologist. Chief Officer of Ideas and Operations at Creative Commercial Real Estate in New York City. Contributed to Chapter 12.

Grace Phillips, Principal of Gracescapes. Sustainable landscape professional. Master's of Urban Planning student. Contributed to Chapter 11.

Francis Reilly, Urban Planner. Prepared the InDesign layout for the manual.

James Rojas, Urban Planner. Founder of the Latino Urban Forum. Contributed to Chapter 9.

David Sargent, Principal at Sargent Town Planning. Contributed to Chapter 13.

Will Schroeer, Director of Policy and Research for Smart Growth America. Wrote Chapter 14.

Jessica Scully, Writer and Editor. Former technical communication instructor at the University of California, Irvine. Edited the entire manual.

Chanda Singh, Transportation Planner with Ryan Snyder Associates. Contributed to Chapters 3 and 6.

Heather Smith, Planning Director of the Congress for New Urbanism. Played a significant role in producing the Context Sensitive Design Solutions for Major Urban Thoroughfares for Walkable Communities. Contributed to Chapter 3.

Pat Smith, ASLA, AICP, Certified Arborist. Principal of Patricia Smith Landscape Architecture. Contributed to Chapter 11.

Gary Toth, Senior Director, Transportation Initiatives for the Project for Public Spaces. Primary author of the Pennsylvania and New Jersey State Departments of Transportation Smart Transportation Guide. Contributed to Chapter 9.

Michael Wallwork, PE. President of Alternate Street Design. Traffic engineer and nationally renowned roundabout and traffic calming designer. Contributed to Chapters 4, 5, and 10.

Michele Weisbart, Graphic and Web Designer. Created most of the graphics in the manual as well as the layout.

Scott Windley, Accessibility Specialist, U.S. Access Board. Contributed to Chapter 6.

Will Wright, Director of Government and Public Affairs for the American Institute of Architects in Los Angeles. Contributed to Chapter 2.

Sky Yim, Sky Yim Photography. Contributed many of the photos.

Paul Zykofsky, AICP, Associate AIA. Associate Director, Local Government Commission. Federal Highway Administration Pedestrian Safety Design Instructor, Complete Streets Instructor, National Safe Routes to School Instructor. Contributed content editing.

Chapter 1. INTRODUCTION

CONTEXT.....	1-2
LEGAL STANDING OF STREET MANUALS.....	1-3
AASHTO Green Book.....	1-3
California Highway Design Manual.....	1-4
Local Street Manuals.....	1-4
MUTCD.....	1-7
California Fire Code.....	1-8
California Streets and Highways Code and California Vehicle Code.....	1-9
PURPOSE OF THE MANUAL.....	1-10
HOW TO USE THE MANUAL.....	1-12
ADOPTION AND IMPLEMENTATION.....	1-13
HOW THIS MANUAL WAS CREATED.....	1-14



CONTEXT



Lively street (Credit: Ryan Snyder)

A growing number of communities are discovering the value of their streets as important public spaces for many aspects of daily life. People want streets that are safe to cross or walk along, offer places to meet people, link healthy neighborhoods, and have a vibrant mix of retail. More people are enjoying the value of farmers' markets, street festivals, and gathering places. And more people want to be able to walk and ride bicycles in their neighborhoods.

People from a wide variety of backgrounds are forming partnerships with schools, health agencies, neighborhood associations, environmental organizations, and other groups in asking their city councils to create streets and neighborhoods that fit this vision.

As a result, an increasing number of cities are looking to modify the way they design their streets. They are often stifled by standards and guidelines that prevent them from making the changes they seek. Some want to modify their standards and manuals, but don't know how, or don't have the resources. This manual presents an opportunity to these communities to design their streets for health, safety, livability, sustainability, and more. It also provides a template that can be adopted to replace existing manuals. The sponsors of this manual make it freely available to any community that wants to use all or any part of it. This manual may be modified, customized, or expanded upon at the pleasure of the end user. We hope that by making it widely available, many more communities will fulfill their dreams in making and remaking their streets valuable public space that serves many needs.

LEGAL STANDING OF STREET MANUALS

Local jurisdictions generally follow some established standards for designing streets. Much confusion exists as to what they must follow, what is merely guidance, when they can adopt their own standards, and when they can use designs that differ from existing standards. The text below untangles the myriad of accepted design documents. It is critical for cities and counties to understand how adopting this manual meshes with other standards and guides. The most important of those standards and guides are the following:

- The American Association of State Highway and Transportation Officials' (AASHTO) *A Policy on Geometric Design of Highways and Streets* (the "Green Book")
- The California *Highway Design Manual*
- Local manuals or street design standards
- The *Manual on Uniform Traffic Control Devices (MUTCD)*
- The California Fire Code
- The California Streets and Highways Code and California Vehicle Code

A discussion of the federal-aid roadway classification system helps to frame the requirements of each of these documents. Local governments that wish to use certain federal funds must use a street classification system based on arterials, collectors, and local streets. These funds are for streets and roads that are on the federal-aid system. Only arterials and certain collector streets are on this system. In Chapter 3, "Street Networks and Classifications," this manual recommends an alternative system. To maintain access to these federal funds, local jurisdictions can use both systems. The federal aid system encourages cities to designate more of these larger streets, and to concentrate modifications along these larger streets. Nevertheless, for the purposes of understanding design standards and guides, this is the existing system of street classification for federal funding.

AASHTO Green Book

The Green Book provides guidance for designing geometric alignment, street width, lane width, shoulder width, medians, and other street features. The Green Book applies only to streets and roads that are part of the National Highway System (NHS). These are Interstate

Freeways, principal routes connecting to them, and roads important to strategic defense. These streets and roads comprise about 14 percent of all federal-aid roadway miles in California, and about 4 percent of all roadway miles (Urgo, J., Wilensky, M., and Weissman, S., *Moving Beyond Prevailing Street Design Standards*, The Center for Law, Energy, and the Environment at the Berkeley Law School, 2010). Although the Green Book's application is limited to these streets, some cities apply its recommendations to all streets.

Further, the Green Book provides guidance that cities often unnecessarily treat as standards. The Green Book encourages flexibility in design within certain parameters, as evidenced by the AASHTO publication *A Guide to Achieving Flexibility in Highway Design*. For example, 10-foot lanes, which cities often shun out of concerns of deviating from standards, are well within AASHTO guidelines.

California Highway Design Manual

The California *Highway Design Manual* (HDM) applies only to State Highways and bikeways within local jurisdictions. If cities deviate from the minimum widths and geometric criteria for bikeways spelled out in Chapter 1000 they are advised to follow the exemption process or experimental process as applicable. The HDM does not establish legal standards for designing local streets. However, like the Green Book, some cities apply HDM guidance to all streets.

As of the writing of this manual, Caltrans is in the process of revising the HDM to meet Caltrans' commitment to Complete Streets in Deputy Directive 64-R1.

Local Street Manuals

Local jurisdictions follow the Green Book, the HDM, or design guidance from organizations such as the Institute of Transportation Engineers (ITE) out of liability concerns. Neither federal nor state law mandates adoption or adherence to these guides. However, municipalities often adopt them to protect themselves from lawsuits. Further, many don't have the resources to develop their own standards and practices, so they adopt those in the Green Book, the HDM, or another previously adopted manual, or those of other cities.

A question often posed by plaintiffs' attorneys in traffic-related crashes is, "Did they follow established or prevailing designs, standards, and guidance?" If the attorneys can prove that the local jurisdiction deviated from these, they enhance their chances of winning a judgment against the jurisdiction. Therefore, protection from liability is paramount.

Cities are authorized to adopt or modify their own practices, standards, and guidelines that may reflect differences from the Green Book and the HDM. If these changes generally fall within the range of acceptable practice allowed by nationally recognized design standards, the adopting agencies are protected from liability to the same extent they would be if they applied the Green Book or the HDM. Most changes to streets discussed in this manual fall within the range of the guidelines or recommended practices of nationally recognized organizations such as AASHTO, ITE, Urban Land Institute (ULI), and Congress for the New Urbanism (CNU).

Working within previously established regional guidelines generally should result in a design that is protected from liability. The Green Book and the HDM are silent on many design features, and do not consider the needs within unique contexts. In these cases, cities can develop their own guidelines and standards and incorporate international equivalents or practices from other cities. Cities may adopt the guidance in this manual, which compiles best practices in creating living streets. This manual could, in effect, become the legal prevailing standard by which liability would be assessed.

Cities can also utilize designs that fall outside the ranges specified by nationally accepted guidelines and standards, but these practices can potentially increase liability unless done with great care. When agencies elect to utilize designs that fall outside the guidelines of nationally recognized documents, they need to use additional care to ensure they do not expose themselves to liability.

To minimize liability, local jurisdictions either need to adopt their own standards (which should be based on rationale or evidence of reasonableness), or they can conduct an experimental project. When conducting an experimental project, agencies need to show that they are using the best information that is reasonably available to them at the time, document why they are doing what they are doing, use a logical process, and monitor the results and modify accordingly. This is because the agency may be required in the future to show that its design is reasonable, and the agency may not be able to cite a nationally published guideline or recommendation to support its local

action. Often, these experimental projects are conducted because the design engineer has reason to believe that the new or evolved design will be safer or otherwise more effective for some purpose than if the project had prevailing standards and guides been used. These reasons or rationales are based on engineering judgment and should be documented to further minimize exposure to liability.

Unless otherwise noted, everything in this manual can readily be adopted and incorporated without fear of increased liability. In addition, this manual carries the credibility of the many top-level experts who produced it.

In some cases, AASHTO design guidelines may not provide information on innovative or experimental treatments that have shown great promise in early experiments and applications. Since AASHTO is a design guide, agencies have some flexibility to use designs that fall outside the boundaries of the AASHTO guide. Deviation from the range of designs provided in the AASHTO guide requires agencies to use greater care and diligence to document their justification, precautions, and determination to deviate from the guidelines. In California, the precautions to establish “design immunity” should be followed. These include consideration/analysis and approval by a registered engineer qualified to sign the plans, and certification by the city council or reviewing body clearly indicating the agency’s intent. This process documents the engineering judgment that went into the design.

Many cities today use various traffic calming measures to slow traffic and to improve neighborhood livability. Traffic calming measures are not traffic control devices and therefore the state exercises no jurisdiction over them.

Local agencies may currently use many other reports and documents to guide their roadway design and transportation planning. Other documents provide valuable procedure and reference data, but they do not set standards. They can be referred to and defined as standards by local agencies, but the local authority often has the flexibility to selectively endorse, modify, or define how these informational documents can be used or incorporated into its engineering and planning processes. Also, newer versions of these documents have additional information that can conflict with the local historical approach.

The expected results of the design approaches presented in this document are generally intended to improve safety and/or livability.

As a result, implementation of these features should generally reduce liability and lawsuits. There is no way to prevent all collisions or lawsuits, but adopting policies, guidelines, and standards and doing experimental projects with reasonable precautions is a defensible approach.

MUTCD

The MUTCD provides standards and guidance for the application of all allowed traffic control devices including roadway markings, traffic signs, and signals. The Federal Highway Administration oversees application of the MUTCD. California cities must follow the California MUTCD, which generally mirrors the federal MUTCD, but not always.

The rules and requirements for the use of traffic control devices are different than for street design criteria. Local agencies have limited flexibility to deviate from the provisions of the California MUTCD in the use of traffic control devices due to the relationship between the MUTCD and state law. The California MUTCD does provide flexibility within its general provisions for items such as application of standard traffic control devices, use of custom signs for unique situations, traffic sign sizes, and sign placement specifics. In contrast, agencies do not generally have the flexibility to develop signs that are similar in purpose to signs within the manual while using different colors, shapes, or legends. Agencies are also not authorized to establish traffic regulations that are not specifically allowed or are in conflict with state law. The provisions of the California MUTCD and related state laws thus make it difficult to deploy new traffic control devices in California. This can result in complications, especially in the areas of speed management, pedestrian crossings, and bikeway treatments.

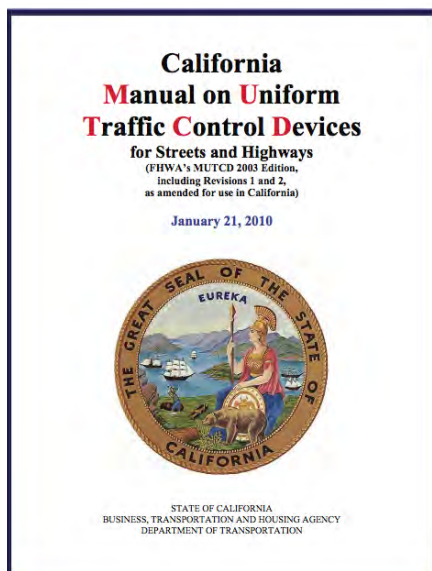

The State of California and the Federal Highway Administration have procedures that allow local agencies to experiment with traffic control devices that are not included in the current MUTCD. Such demonstrations are not difficult to obtain from the Federal Highway Administration for testing of new devices, especially as they relate to pedestrian and bicycle facilities, but the requesting agency must agree to conduct adequate before-and-after studies, submit frequent reports on the performance of the experimental device, and remove the device if early results are not promising. The State process can be more difficult for obtaining approval. Federal approval must be obtained

first. The California Traffic Control Devices Committee advises Caltrans, which must then agree to allow the experiment to be conducted and determine that the experiment is not in conflict with State law. Once approval is granted for the experiment, the city has been given some legal immunity from liability suits. Since the California Vehicle Code is written to mirror the MUTCD, provisions within the Vehicle Code may not allow the experiment to proceed. The need to modify the Vehicle Code can complicate obtaining State permission to experiment.

Both the federal and California MUTCD are amended through experimentation. After one or more experiments have shown benefit, the new devices are sometimes adopted into these manuals. In California, the Vehicle Code must be changed first if the Vehicle Code prevents use of the new device.

The federal MUTCD and California MUTCD establish warrants for the use of some traffic control devices. For example, stop signs, traffic signals, and flashing beacons are expected to meet minimum thresholds before application. These thresholds include such criteria as number of vehicles, number of pedestrians or other users, distance to other devices, crash history, and more. These warrants often prevent local engineers from applying devices that, in their opinion, may improve safety. For example, trail and/or pedestrian crossings of busy, high-speed, wide arterial streets may need signals for user safety, but they may not meet the warrants.

As with street design guidelines, cities may establish their own warrants or modify those suggested by the California MUTCD to suit their context in order to use some traffic control devices. In special circumstances that deviate from their own warrants, cities need to document their reasons for the exception. For example, they may say the trail crossings or school crossings qualify for certain traffic control devices.

California Fire Code

The California Fire Code can impede street design in limited circumstances. The state legislature has adopted the National Fire Code. The National Fire Code is written by a private agency and has no official legal standing unless states or municipalities adopt it, as has been done in California. The primary barrier caused by this adoption is the requirement for a minimum of 20 feet of an unobstructed clear

path on streets. To comply with this, streets with on-street parking on both sides must be at least 34 feet wide. This prevents municipalities from designing “skinny” and “yield” streets to slow cars and to make the streets safer, less land consumptive and more hospitable to pedestrians and bicyclists.

There are ways around this requirement. If the local jurisdiction takes measures such as installing sprinklers and adding extra fire hydrants, or the adjacent buildings are built with fire retardant materials, it may be able to get the local fire department to agree to the exception.

Alternatively, the state legislature could repeal its adoption of the 20-foot clear path requirement due to

- The arbitrary and unresearched nature of the provision
- The safety problems associated with the resulting excessively wide streets
- The contradiction that this provision causes with properly researched guidelines and standards by ITE, CNU, AASHTO, and others for streets under 34 feet wide
- The potential liability that the 20-foot clear provision creates for designers who maintain, modify, or design streets that do not provide 20-foot clear paths

It is likely that the state legislature was unaware of these issues when it adopted the code in its entirety.

California Streets and Highways Code and California Vehicle Code

The California Streets and Highways Code and the California Vehicle Code include laws that must be followed in street design. These are embodied in the California MUTCD. Changes to the Streets and Highways Code and the Vehicle Code may cause the California MUTCD to change.

PURPOSE OF THE MANUAL



*Narrow and obstructed sidewalk
(Credit: Ryan Snyder)*

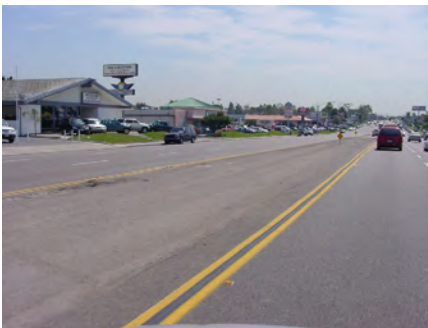

*Unsafely and uninviting street
(Credit: Ryan Snyder)*

Municipalities depend on street manuals for guidance to design their streets, to retrofit and to modify existing streets with new development, and when new subdivisions are built. Along with land use planning, street manuals play a large role in determining urban form. Street manuals, in effect, serve as the “DNA” of streets. As such, they help to determine how walkable and bicycle-friendly neighborhoods and communities are, how conducive cities are to transit use, and how livable communities become.

The manuals that many jurisdictions use today embody principles based on moving motor vehicle traffic as the primary role of streets. The result is many wide, high-speed streets that move cars but compromise other important community goals and work against present day community needs. Common direct outcomes of existing manuals include the following:

- Streets that are nerve-racking and not safe for pedestrians to cross
- Streets that are not safe to bicycle on
- Streets that encourage high speeds
- Streets that are not safe for the motorists they are designed to serve
- Narrow sidewalks that are not comfortable to walk along
- Inconvenient street crossings for people in wheelchairs



*Unsafe pedestrian crossing
(Credit: Dan Burden)*

- Unsightly and uninviting streets
- Auto-oriented land uses that are uninviting and intimidating to people walking, biking, and using transit
- Street water runoff systems that funnel rainwater to the storm drains and directly to waterways
- Poor selection of street trees, if any
- Excessive exposed hardscape leading to a rise in summer temperatures – the heat-island effect

These indirectly cause a number of problems for communities, including the following:

- Obesity from inactive life styles
- Rising rates of diabetes, heart disease, cancer, and other negative health outcomes of sedentary lifestyles
- Senior citizens being trapped inside a small neighborhood because they can't cross streets
- Children becoming overweight, unnecessary neighborhood congestion, and air pollution around schools, all due to children being driven to school rather than walking
- Unnecessary driving for short trips
- Overconsumption of energy
- Unnecessary emission of global warming gases
- Economic hardship and recession when energy prices rise
- Streets that don't support neighborhood retail
- Neighborhoods that lack livability
- Polluted waterways
- Underground water aquifers drying up
- Dehydrated streetscapes causing unnecessary importation of water for landscaping
- Uplifted sidewalks



*Uplifted sidewalk
(Credit: Ryan Snyder)*

This manual is based on complete streets principles that design streets for people of all ages and physical abilities and accommodate all travel modes. The manual goes beyond complete streets to living streets. Living streets principles embody complete streets and also include consideration of other issues related to economic vibrancy, equity, environmental sustainability, aesthetics, and more. This manual offers another way to design streets and provides guidance for those municipalities that decide to adopt these principles. The result will be more livable neighborhoods with healthier residents due to opportunities for active transportation (walking and cycling).

HOW TO USE THE MANUAL

Since many municipalities lack the resources to undertake a major revision of their manuals, this model manual offers a template for local jurisdictions to begin updating existing manuals. Cities may use this manual in any way that helps them update their current practices, including adopting the entire manual and inserting the city's name into the text. They may also choose to adopt certain chapters in full or in part.

Many cities will likely want to customize the manual for their own context and streets. They may adopt some chapters as written and modify others, or amend this manual by providing more in-depth guidance on selected topics, or adding new components not included here.



*Complete street: Santa Barbara, CA
(Credit: Ryan Snyder)*



*Untreated runoff
(Credit: Ryan Snyder)*

California cities can use this manual to assist them with new requirements of the California Complete Streets Act mandating that new circulation elements of general plans be based on complete streets principles. The manual helps cities comply with the law and implement these principles. Any city that adopts complete streets principles may also use the manual as a key component of implementation.

Similarly, Los Angeles County cities must comply with a Regional Water Quality Board mandate to reduce the amount of stormwater runoff by retaining more water on site. This manual introduces new stormwater (herein referred to as “streetwater”) management techniques in order to comply with this requirement. Implementing these techniques will reduce runoff into rivers, streams, and the ocean while recharging underground water supplies. Many jurisdictions across the U.S. need to adopt sustainable stormwater management practices to retain water on site as a water conservation measure, as well as to reduce pollution in their watersheds and lakes or oceans.

This manual is available to any city or local jurisdiction in Los Angeles County, or anywhere in the U.S., that wishes to adopt or use it. The manual is offered in a MS Word format to allow customization. The manual’s sponsors ask cities using it to do two things:

1. Keep the acknowledgements pages to recognize the people whose contribution made this manual possible and to carry the credibility of the authors with the document
2. Inform the manual’s sponsors (via means described in the acknowledgements) that they have used the manual so the sponsors can track jurisdictions benefitting from it

ADOPTION AND IMPLEMENTATION

This manual is suitable for adoption by local and regional agencies to guide planning and design of streets. This adoption process allows agencies to indicate that the features and provisions of the plan are applicable for use by the adopting agency. This is a necessary first step in properly incorporating the provisions of the street manual. However, agencies will have to take additional steps to ensure that their implementation practices are modified to reflect the recommendations of this manual.

Local agencies will likely need to review their stepwise approach to street design through all stages of the process, from advance planning through preliminary design and construction. Critical points will include project identification, preliminary cost estimates for funding, and a multi-disciplinary approach to preparation of design drawings.

During adoption, as well as after adoption, local jurisdictions will need to ensure that their various city departments are all operating with the same practices. These include agencies such as but not limited to public works, traffic engineering, transportation planning, street services, maintenance, signal operations, street lighting, planning, redevelopment, fire, and other departments.

HOW THIS MANUAL WAS CREATED

This manual is a project of the Los Angeles County Department of Public Health. The department funded the production of this manual through a federal Communities Putting Prevention to Work grant to expand opportunities for people to bicycle and walk as an obesity prevention effort. The Luskin Center for Innovation at the University of California, Los Angeles, funded Chapter 11, "Streetscape Ecosystem," to address environmental sustainability issues related to streets.

A team including many of the top street designers in the U.S. produced this manual. The team comprised experts from traffic engineering, transportation planning, land use planning, architecture, landscape architecture, public health, sociology, and other backgrounds. The team also included experts serving in leadership roles for the following national and local organizations:

- AARP Public Policy Institute
- American Society of Landscape Architects
- Association of Pedestrian and Bicycle Professionals
- California Department of Health Services
- California Strategic Growth Council
- City of Long Beach
- City of Los Angeles Planning Department
- Council for Watershed Health

- Council for Watershed Health
- Congress for the New Urbanism
- Federal Highway Administration
- Green Los Angeles Coalition
- Institute of Transportation Engineers
- Los Angeles Chapter of the American Institute of Architects
- Los Angeles County Department of Public Health
- National Complete Streets Coalition
- Project for Public Spaces
- Safe Routes to School National Partnership
- Smart Growth America
- UCLA Luskin Center for Innovation
- US Access Board
- Walkable and Livable Communities Institute

The multidisciplinary nature of this team created concepts for streets that reflect viewpoints from various perspectives and lenses.



Manual authors at charrette
(Credit: Dan Burden)

Chapter 2. VISION, GOALS, POLICIES, AND BENCHMARKS

INTRODUCTION.....	2-2
VISION.....	2-2
GOALS.....	2-3
POLICIES.....	2-4
CREATING A NEW SET OF BENCHMARKS AND PERFORMANCE MEASURES.....	2-7
Benchmarks.....	2-8
Performance Measures.....	2-8



INTRODUCTION

This chapter sets the philosophical framework for the street design manual. A manual should not prescribe how to design every segment of every street; rather, after clearly defining what a community wants to accomplish with its streets, designers can apply this framework along with the specific guidance from other chapters to meet the community's goals.

VISION

This manual aims to design streets that adhere to a vision of living streets. It starts with the premise that any changes or improvements to streets should add value to the adjacent land and neighborhoods. The bullets below paint the vision of living streets. Living streets

- Integrate income, racial, and social equity into their design and function
- Are designed for people of all ages and physical abilities whether they walk, bicycle, ride transit, or drive
- Integrate connectivity and traffic calming with pedestrian-oriented site and building design to create safe and inviting places
- Connect people through everyday interaction
- Involve local people to share the responsibility for designing their streets
- Are inviting places with engaging architecture, street furniture, landscaping, and public art that reflect the diversity and cultures of the neighborhood
- Foster healthy commerce
- Strengthen and enhance neighborhoods as envisioned by community members without displacing current residents
- Encourage active and healthy lifestyles
- Integrate environmental stewardship, water management, energy conservation, and preservation of plant life
- Vary in character by neighborhood, density, and function



*Street teeming with pedestrians:
Barcelona, Spain
(Credit: Ryan Snyder)*

GOALS

Goals state the broad, overriding outcomes a city wants to achieve. The goals of designing living streets are to

- Serve the land uses that are adjacent to the street; mobility is a means, not an end
- Encourage people to travel by walking, bicycling, and transit, and to drive less
- Provide transportation options for people of all ages, physical abilities, and income levels
- Enhance the safety and security of streets, from both a traffic and personal perspective
- Improve peoples' health
- Create livable neighborhoods
- Reduce the total amount of paved area
- Reduce streetwater runoff into watersheds
- Maximize infiltration and reuse of stormwater
- Reduce greenhouse gas emissions and other air pollution
- Reduce energy consumption
- Promote the economic well-being of both businesses and residents
- Increase civic space and encourage human interaction



*Walkable communities are livable communities
(Credit: Dan Burden)*

POLICIES

Policies implement the vision and goals. Table 2.1 below aligns living streets policies with the 10 elements for complete streets established by the National Complete Streets Coalition. These are only suggested strong policies. Local jurisdictions may follow this template, or adopt other similar policies. If cities follow these policies, they will make progress toward meeting their goals and carrying out the vision of the tenets. Cities (or counties) should enact these policies through a living streets ordinance or resolution.

Table 2.1 Streets Elements and Policies

Complete Streets Elements	Living Streets Policies
Vision	<p>Cities will develop policies and practices that cause them to design their streets according to the bullet points in the Vision section above.</p>
All Users and All Modes	<p>Cities will incorporate the full range of appropriate living streets elements when planning and designing their transportation networks.</p> <p>Cities will enhance the safety, access, convenience, and comfort of users of all ages and abilities. Cities understand that children, elderly adults, and persons with disabilities will require special accommodations.</p> <p>Cities will plan, design, and build high quality access and mobility for pedestrians, bicyclists, and transit passengers.</p>
Connectivity	<p>Cities will design, operate, and maintain a transportation system that provides a highly connected network of streets that accommodate all modes of travel.</p> <p>Cities will seek opportunities to repurpose rights-of-way, and to add new rights-of-way to enhance connectivity for pedestrians, bicyclists, and transit.</p> <p>Cities will prioritize non-motorized connectivity improvements to services, schools, parks, civic uses, regional connections, and commercial uses.</p> <p>Cities will require large, new developments to provide interconnected street networks with small blocks that connect to existing or planned streets on the perimeter of the development.</p>
Jurisdiction	<p>A city's living streets policy document is intended to cover all roads, streets, and alleys in the city.</p> <p>Every city agency, including public works, planning, redevelopment, street services, and others will follow the policies in this document.</p> <p>Cities will require all developers to obtain and comply with their standards.</p>

Table 2.1 continued

Complete Streets Elements	Living Streets Policies
<p>Phases</p>	<p>Cities will apply their living streets policy document to all roadway projects including those involving operations, maintenance, new construction, reconstruction, retrofits, repaving, rehabilitation, or changes in the allocation of pavement space on an existing roadway. This also includes privately built roads intended for public use.</p> <p>Living streets may be achieved through single projects or incrementally through a series of smaller improvements or maintenance activities over time.</p> <p>Cities will draw on all sources of transportation funding to implement living streets.</p>
<p>Exceptions</p>	<p>Living streets will be included in all street construction, reconstruction, repaving, and rehabilitation projects, except under one or more of the following conditions:</p> <ul style="list-style-type: none"> A. A project involves only ordinary maintenance activities designed to keep assets in serviceable condition, such as mowing, cleaning, sweeping, spot repair, concrete joint repair, or pothole filling, or when interim measures are implemented on temporary detour or haul routes. B. The city council exempts a project due to an excessively disproportionate cost of establishing a bikeway, walkway, or transit enhancement as part of a project. C. The city engineer and the director of the planning department jointly determine that the construction is not practically feasible or cost effective because of significant or adverse environmental impacts to waterways, flood plains, remnants of native vegetation, wetlands, mountainsides, or other critical areas, or due to impacts on neighboring land uses, including from right of way acquisitions. D. The director of transportation issues a documented exception that application of living streets principles is unnecessary or inappropriate. E. The director of the planning department issues a documented exception where changes to the street may detract from the historical or cultural nature of the street or neighborhood.

Table 2.1 continued

Complete Streets Elements	Living Streets Policies
<p>Design</p>	<p>Cities will adopt new living streets design guidelines to guide the planning, funding, design, construction, operation, and maintenance of new and modified streets while remaining flexible to the unique circumstances of different streets where sound engineering and planning judgment will produce context-sensitive designs.</p> <p>Cities will incorporate the street design guidelines’ principles into all city plans, manuals, rules, regulations, and programs as appropriate. As new and better practices evolve, cities will incorporate those as well.</p> <p>Cities will keep street pavement widths to the minimum necessary.</p> <p>Cities will provide well-designed pedestrian accommodation in the form of sidewalks or shared-use pathways on all arterial and collector streets and on local streets.</p> <p>Cities will provide frequent, convenient and safe street crossings. These may be at intersections designed to be pedestrian friendly, or at mid-block locations where needed and appropriate.</p> <p>Cities will provide bicycle accommodation along all avenues, boulevards, and connector streets.</p> <p>Where physical conditions warrant, cities will plant trees and manage streetwater whenever a street is newly constructed, reconstructed, or relocated.</p>
<p>Context Sensitivity</p>	<p>Cities will plan their streets in harmony with the adjacent land uses and neighborhoods.</p> <p>Cities will design their streets with full input from local stakeholders.</p> <p>Cities will design their streets in harmony with natural features such as waterways, slopes, and ravines.</p> <p>Cities will design their streets with a strong sense of place. They will use architecture, landscaping, streetscaping, public art, signage, etc. to reflect the community, neighborhood, history, and natural setting.</p> <p>Cities will coordinate with merchants along Main Street corridors to develop vibrant retail districts.</p>

Table 2.1 continued

Complete Streets Elements	Living Streets Policies
Performance Measures	* Use performance measures below
Implementation Plan	<p>Cities will adopt and apply this design manual.</p> <p>Cities will incorporate living streets concepts into the next circulation element of their general plans.</p> <p>Cities will either implement living streets designs on every street, or initiate the process by preparing and adopting bicycle plans, pedestrian plans, green streets plans, Safe Routes to School plans, and an Americans with Disabilities Act transition plan.</p> <p>Cities will prepare and adopt a storm water mitigation plan that aims to capture streetwater runoff on site.</p>

CREATING A NEW SET OF BENCHMARKS AND PERFORMANCE MEASURES

Conventional street design applies auto-centric performance measures. The most common is the Level of Service (LOS), which seeks to maintain flow of vehicles and leads to widening streets and intersections, removing on-street parking, and other strategies to accommodate the flow of traffic. These techniques undermine the goals and tenets of living streets.



*Vulnerable users crossing street
(Credit: Dan Burden)*

To meet the goals and tenets of living streets, communities should adopt the following benchmarks and performance measures.

Benchmarks

- Every street and neighborhood is comfortable to walk and bicycle in.
- Every child can walk or bike to school safely.
- Seniors, children, and disabled people can cross all streets safely and comfortably.
- An active way of life is available to all.
- There are zero traffic fatalities.
- No unfiltered streetwater flows into local waterways or the ocean.
- Retail streets become one of the most popular destinations for tourists in the country.

Performance Measures

- Street fatalities and injuries decrease for all age groups.
- The number of trips by walking, cycling, and transit increases.
- Vehicle travel is reduced.
- Prevailing speeds of vehicles on local streets decrease.
- Streetwater runoff is reduced.
- Water quality in rivers and the ocean improves.
- Retail sales and tourism increase.
- Resident satisfaction increases.



Multimodal street: Madison, WI (Credit: Ryan Snyder)

Chapter 3. STREET NETWORKS AND CLASSIFICATIONS

INTRODUCTION.....	3-2
ESSENTIAL PRINCIPLES OF SUSTAINABLE STREET NETWORKS.....	3-4
STREET CHARACTERISTICS AND CLASSIFICATIONS.....	3-4
Context: The Transect.....	3-6
DESIGN STANDARDS.....	3-7
Types and Roles of Streets.....	3-8



INTRODUCTION

The United States has a long and distinguished history of creating memorable and enduring cities, such as Savannah, Charleston, Washington, D.C., Boston, Santa Monica, and San Francisco. These cities are memorable and enduring partly because of their street networks. Well-planned street networks help create sustainable cities that support the environmental, social, and economic needs of their residents.

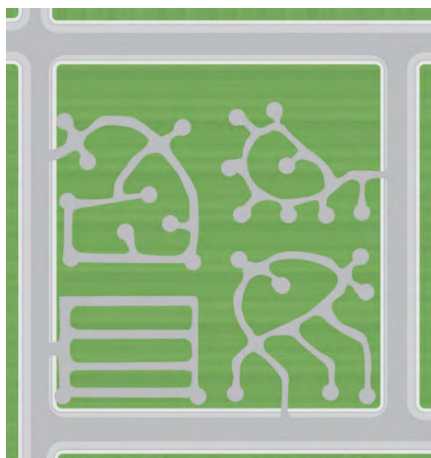

Cul-de-sac developments break up connectivity and create longer trips (Credit: Michele Weisbart)

Over 30,000 Americans perish each year in traffic crashes (National Highway Traffic Safety Administration, Data Resource Website, 2009 data). For the following reasons, a good street network is a powerful tool for reducing traffic crashes and fatalities while creating beautiful places:

- **Sustainable street networks improve traffic safety.** Hierarchical street patterns (arterial-collector-local) with cul-de sac subdivisions depending on arterials do not perform as well as sustainable street networks and cause more traffic crashes. Hierarchical street networks divert traffic to high-speed arterials that have large intersections. Most crashes occur at intersections. The speed at which motor vehicles move on these arterial streets increases the likelihood and severity of crashes.

A 2011 study of 24 California cities found a 30 percent higher rate of severe injury and a 50 percent higher chance of dying in cities dominated by sparsely connected culs-de-sac compared with cities with dense, connected street networks (Marshall, W. and Garrick, N., "Does the Street Network Design Affect Traffic Safety?" *Accident Analysis and Prevention* 43[3]: 769-781). A 2009 study from Texas found that each mile of arterial is associated with a 10 percent increase in multiple-vehicle crashes, a 9.2 percent increase in pedestrian crashes, and a 6.6 percent increase in bicyclist crashes (Dumbaugh, E.R. Rae, "Safe Urban Form: Revisiting the Relationship between Community Design and Traffic Safety," *Journal of the American Planning Association* 75[3]:309-329).

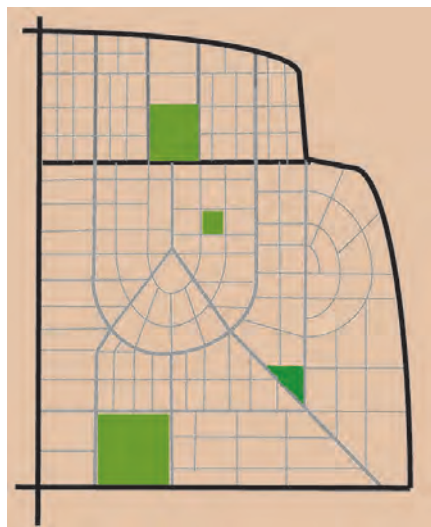

Interconnected street network with small blocks (Credit: Marty Bruinsma)

- **Sustainable street networks increase the number of people walking and bicycling and reduce vehicle miles traveled.** Connectivity enables people to take shorter routes. It also enables them to travel on quieter streets. These shorter routes on quiet streets are more conducive to bicycling and walking. The California study cited above found that places with a dense, connected street network had three to four times more

people walking, bicycling, or using transit to get to work. This in turn led to a 50 percent reduction in vehicle miles traveled per capita in these cities (Marshall, W. and Garrick, N., "The Spatial Distribution of VMT Based upon Street Network Characteristics," 90th Meeting of the Transportation Research Board, Washington, D.C., January 2011).

- **Sustainable street networks allow more effective emergency response.** Studies in Charlotte, North Carolina, found that when one connection was added between cul-de-sac subdivisions, the local fire station increased the number of addresses served by 17 percent and increased the number of households served by 12 percent. Moreover, the connection helped avoid future costs by slowing the growth of operating and capital costs; most of the cost to run a fire station is in salaries. Furthermore, Congress for the New Urbanism's report on emergency response and street design found that emergency responders favor well-connected networks with a redundancy of routes to maximize access to emergencies. Emergency responders can get stuck in culs-de-sac and need options when streets back up ("Effect on Connectivity on Fire Station Service Area and Capital Facilities," 2009 presentation by the Charlotte, North Carolina Department of Transportation, charmack.org/city/charlotte/citymanager/CommunicationstoCouncil/2009Communications/Documents/CNUPresentation).

These studies and others provide strong evidence that the benefits of a well-designed street network go beyond safety; they include environmental, social, and economic gains. Sustainable street networks shape land use markets and support compact development, in turn decreasing the costs of travel and providing utilities. Street networks like these are resilient over hundreds of years and accommodate changing technology, lifestyles, and travel patterns. Interconnected street networks can preserve habitat and important ecological areas by condensing development, reducing city edges, and reducing sprawl.

A sustainable and resilient street network fosters economic and social activity. It constrains traffic growth by limiting the number of lanes on each street while providing maximum travel options by collectively providing more lanes on more streets. By providing opportunities for all modes of travel, an ideal street network enhances social equity and provides an ideal setting for high quality design at all scales: building, neighborhood, and region. The resulting communities can be some of the most beautiful places with the highest values in the world.

ESSENTIAL PRINCIPLES OF SUSTAINABLE STREET NETWORKS

Sustainable street networks come in many shapes and forms, but have the following overarching principles in common:

- The sustainable street network both shapes and responds to the natural and built environment.
- The sustainable street network privileges trips by foot, bike, and transit because these are the most sustainable types of trips.
- The sustainable street network is built to walking dimensions.
- The sustainable street network works in harmony with other transportation networks, such as pedestrian, bicycle, transit, and private vehicle networks. Large parts of all of these networks are coincidental with the street network, but if any parts are separate from the street network, they must connect and interact with the network.
- The sustainable street network protects, respects, and enhances a city's natural features and ecological systems.
- The sustainable street network maximizes social and economic activity.

STREET CHARACTERISTICS AND CLASSIFICATIONS

A sustainable street network provides a pattern of multimodal streets that serves all community land uses and facilitates easy access to local, city, and regional destinations. The pattern, which should give priority to non-motorized modes, results in distribution of traffic that is consistent with the desired function of the street. One characteristic of this pattern is that it offers many route choices that connect origins with their destinations.

The street network works best when it provides a variety of street types. The variety is enforced by the pattern of the street network itself but also by the design of individual street segments. Natural and built features, including topography and important community destinations, should be taken into account to create unique designs.

In new subdivisions, integrating a network of shared use paths and earthen trails into the street network should be considered. Under this concept, every fourth or fifth "street" provides quiet, comfortable access for bicyclists, pedestrians, joggers, skaters, and others along a linear parkway without motor vehicles. Where these intersect streets, they should be treated as intersections with appropriate treatments. This type

of network would allow people to circulate in their new communities to schools, parks, stores, and offices while staying primarily on dedicated paths and trails. These networks can also link to paths and trails along waterways, utility corridors, rail rights-of-way, and other more common active transportation corridors. The adjacent diagram illustrates this concept.

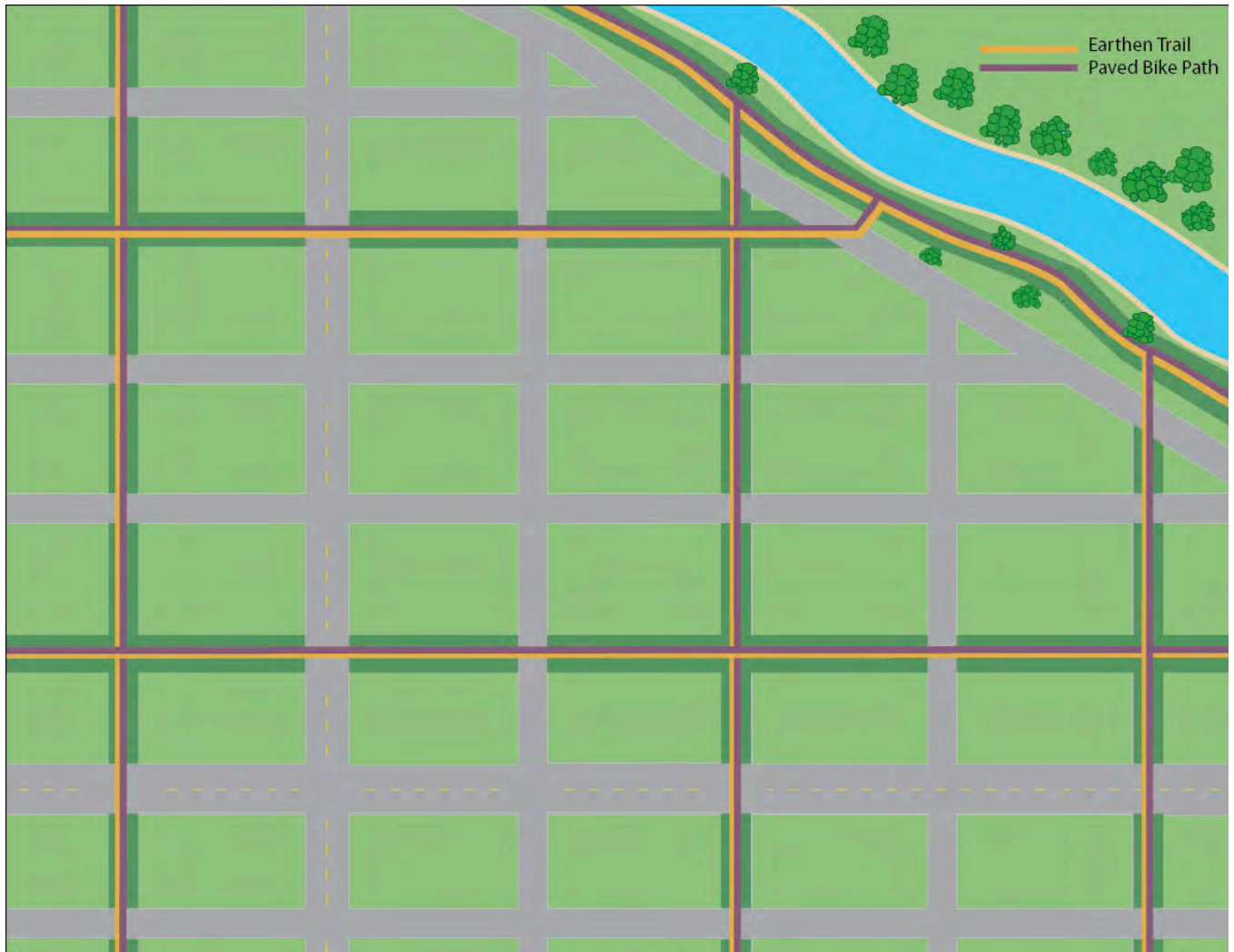

Integrating bicycle and pedestrian paths into new development (Credit: Michele Weisbart)

The types of streets used in the network are described in the design standards below (see number 7). The types differ in terms of their network continuity, cross-section design, and adjoining land use. The individual streets themselves will change in character depending on their immediate land use context.

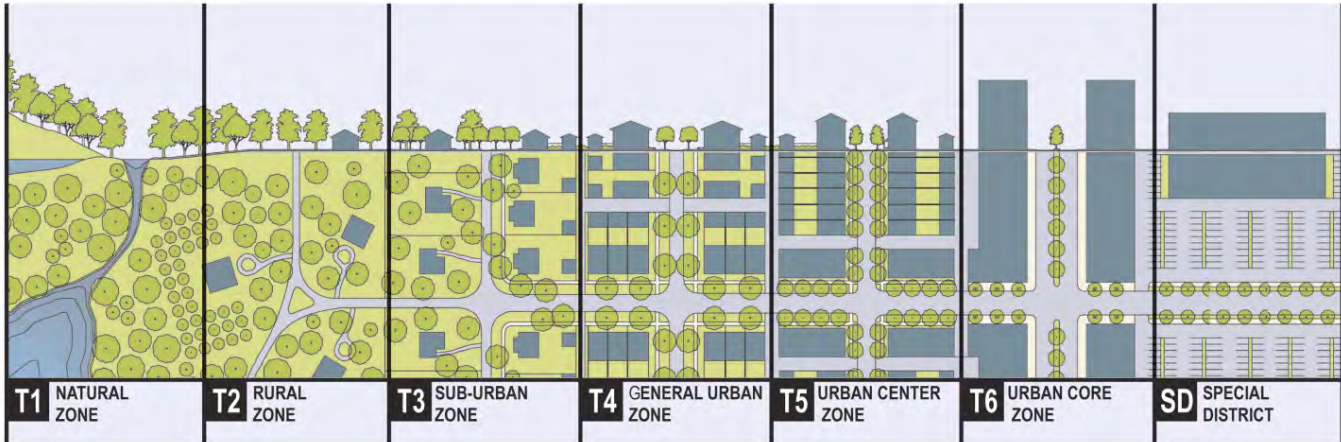

The transect zones (Credit: Duany, Plater, Zyberk & Company)¹

Context: The Transect

Context is the environment in which the street is built and includes the placement and frontage of buildings, adjacent land uses and open space, and historic, cultural, and other characteristics that form the built and natural environments of a given place. The transect is a recognized tool for defining the context and assists designers in creating an appropriate design for the context. Andres Duany of Duany, Plater, Zyberk & Company developed the transect.

The transect zones range from T-1 (Natural) to T-6 (Urban Core). In the least-intensive T-Zones of a community, T1 and T2, a rural road or highway is appropriate.

By definition, the urban T-Zones T3 through T6 do not exist as “stand alone” zones, but rather are organized in relationship to each other within a community. Each T-Zone is highly walkable and assumes the pedestrian mode as a viable and often preferred travel mode, especially for the ¼ mile, five-minute walk.

The T3 suburban zone defines the urban to rural edge. Of all the T-Zones, T3 appears most like conventional sprawl. It has single-family dwellings, a limited mix of uses and housing types, and tends to be more automobile-oriented than T4, T5, or T6. The five-minute test of walkable distance (¼ mile radius) limits the overall size of a T3 transect zone. The T3 zone often defines the edge of the more developed urban condition, so is sometimes called the “neighborhood edge.”

For example, knowing that a particular area is a T5, Town Center, defines the context for the built environment including the street design criteria and elements, such as the width of sidewalks, the presence of on-street parking, and the use of tree wells instead of planting strips.

Buildings built to the sidewalk with parking on the street and behind, for instance, are appropriate in T5 and T6. Referring to a set of tables and design recommendations correlated to the transect helps the designer determine how a street should function in each T-Zone.

Contexts will not always flow evenly and incrementally from T1 to T6: there may be gaps. For example, T2 jumps to T5 may occur, or a rural community may have only T2 with a community center that is not urban enough to be T5 (for example, a church, convenience store, antique store, and gas station at the one intersection in the whole town).

An important element of the design process is to ensure the travelled way design fits the context of the intended design. Through use of a regulating plan, the appropriate street design will be established to fit the context, purpose, and type of street.

DESIGN STANDARDS

1. Establish a block size maximum of 1,600 linear feet (perimeter)
 - Ensure greater accessibility within the block through alleys, service courts, and other access ways
 - Where block size is exceeded, retrofit large blocks with new street, alleys, pedestrian and/or bicycle connections
 - For existing street networks, do not allow street closures that would result in larger blocks
2. Require multiple street connections between neighborhoods and districts across the whole region. This is achieved by having boulevards and avenues that extend beyond the local area. Adjacent neighborhoods must also be connected by multiple local streets.
3. Connect streets across urban freeways so that pedestrians and bicyclists have links to neighborhoods without having to use streets with freeway on and off ramps
4. Maintain network quality by accepting growth and the concomitant expansion of the street network (including development, revitalization, intensification, or redevelopment) while avoiding increases in street width or in number of lanes

5. Provide on-street curbside parking on most streets. Exceptions can be made for very narrow streets, streets with bus lanes, or where there is a better use of the space.
6. Establish maximum speeds of 20 to 35 mph
 - Use design features that support lower-speed environments
 - On local streets, the speed should be 20 to 25 mph or less
7. Maintain network function by discouraging
 - One-way streets
 - Turn prohibitions
 - Full or partial closures (except on bike boulevards, or areas taken over for other uses of public space)
 - Removal of on-street parking (except when replaced by wider sidewalks, an enhanced streetscape, bus lanes, bike lanes, etc. rather than additional vehicle lanes)
 - Gated streets
 - Widening of individual streets
 - Conversion of city streets to limited access facilities
8. Classify major streets using the common street and context types presented in Table 3.1. However, some streets are unique and deserve a special category that lies outside the common street network types. Table 3.2 describes these special streets. Chapter 4, "Traveled Way Design," contains guidance related to cross sections of these street typologies. New street types should be welcomed as well.

Types and Roles of Streets

Federal Highway Function and Classification system contains the conventional classification system that is commonly accepted to define the function and operational requirements for streets. These classifications are also used as the primary basis for geometric design criteria.

Traffic volume, trip characteristics, speed and level of service, and other factors in the functional classification system relate to the mobility of motor vehicles, not bicyclists or pedestrians, and do not consider the context or land use of the surrounding environment. This approach, while appropriate for high speed rural and some suburban roadways, does not provide designers with guidance on how to design for living streets or in a context-sensitive manner.

The street types described here provide mobility for all modes of transportation with a greater focus on the pedestrian. The functional classification system can be generally applied to the street types in this document. Designers should recognize the need for greater flexibility in applying design criteria, based more heavily on context and the need to create a safe environment for pedestrians, rather than strictly following the conventional application of functional classification in determining geometric criteria.

The terms for street types for living streets are described in the following sections. Many municipalities use the terms "avenue" and "street" in combination with the street name as a way to differentiate streets running north and south from those running east and west (e.g., 1st Street, 1st Avenue); these uses differ from the definitions used in this manual.

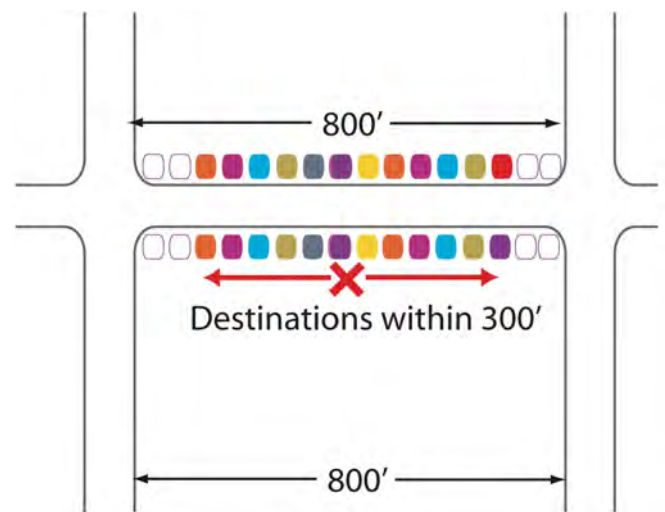

Many more destinations can be reached walking 300' within a network of short blocks than in one with long blocks (Credit: Marty Bruinsma)



Boulevard example: Coronado, CA (Credit: Ryan Snyder)

Boulevard

A boulevard is a street designed for high vehicular capacity and moderate speed, traversing an urbanized area. Boulevards serve as primary transit routes. Boulevards should have bike lanes. They may be equipped with bus lanes or side access lanes buffering sidewalks and buildings. Many boulevards also have landscaped medians.



Avenue example (Credit: Ryan Snyder)

Avenue

An avenue is a street of moderate to high vehicular capacity and low to moderate speed acting as a short distance connector between urban centers and may be equipped with a landscaped median.



Street example: Sanford, FL (Credit: Billy Hattaway)

Street

A street is a local, multi-movement facility suitable for all urbanized transect zones and all frontages and uses. A street is urban in character, with raised curbs (except where curbless treatments are designed), drainage inlets, wide sidewalks, parallel parking, and trees in individual or continuous planters aligned in an alley. Character may vary in response to the commercial or residential uses lining the street.



Alley example: Chapel Hill, NC (Credit: Ryan Snyder)

Alley/Lane

An alley or lane is a narrow street, often without sidewalks. Alleys and lanes connect streets and can provide access to the backs of buildings and garages.

Chapter 3. Street Networks and Classifications

Table 3.1 provides a list of common street types. The special street typologies listed in Table 3.2 have particular functions within the street network.

Table 3.1 Common Street Types

Street Type	Description	Comment
Boulevard* (conventionally arterials)	Traverses and connects districts and cities; primary a longer distance route for all vehicles including transit	Often has a planted median
Avenue* (conventionally collectors)	Traverses and connects districts, links streets with boulevards. For all vehicles including transit.	May or may not have a median
Street* (conventionally local streets)	Serves neighborhood, connects to adjoining neighborhoods; serves local function for vehicles and transit	
Alley/Lane	Link between streets; allows access to garages	Narrow and without sidewalks
*May have segments with specialized functions and features such as a Main Street segment.		

Table 3.2 Special Street Types

Street Type	Description	Comment
Main Street	Slower vehicle speeds, favors pedestrians most, contains the highest level of streetscape features, typically dominated by retail and other commercial uses	Functions differently than other streets in that it is a destination
Drive	Located between an urbanized neighborhood and park or waterway	
Transit Mall	The traveled way is for exclusive use by buses or trains, typically dominated by retail and other commercial uses	Excellent pedestrian access to and along the transit mall is critical. Bicycle access may be supported.
Bike Boulevard	A through street for bicycles, but short distance travel for motor vehicles	Usually a local street with low traffic volumes
Festival Street	Contains traffic calming, flush curbs, and streetscape features that allow for easy conversion to public uses such as farmers' markets and music events	
Shared Space	Slow, curbless street where pedestrians, motor vehicles, and bicyclists share space	May support café seating, play areas, and other uses

Chapter 3. Street Networks and Classifications



*16th Street Transit Mall: Denver, CO
(Credit: Ryan Snyder)*



*Shared space: Copenhagen, Denmark
(Credit: Ryan Snyder)*

Chapter 4. TRAVELED WAY DESIGN

INTRODUCTION.....	4-2
ESSENTIAL PRINCIPLES OF TRAVELED WAY DESIGN.....	4-3
FACTORS AFFECTING STREET DESIGN.....	4-4
Users.....	4-4
Traffic Volume and Composition.....	4-6
Design Speed.....	4-7
Multi-Modal Level of Service.....	4-9
Access Management.....	4-12
CROSS SECTIONAL ELEMENTS.....	4-14
On-Street Parking.....	4-14
Bicycle Facilities.....	4-16
Transit Facilities.....	4-16
Travel Lanes.....	4-16
Medians.....	4-18
Sample Cross Sections.....	4-20
OTHER GEOMETRIC DESIGN ELEMENTS.....	4-27
Vertical Alignment.....	4-27
Horizontal Alignment.....	4-27
Sight Distance.....	4-27
Horizontal Clearance/Clear Zone.....	4-28
Traveled Way Lighting.....	4-29
MODEL PROJECT.....	4-30
La Jolla.....	4-30



INTRODUCTION

Streets and their geometric design have traditionally focused on the movement of motor vehicles, resulting in street environments that neglect other users. This emphasis can be seen in wide travel lanes, large corner radii, and turn lanes that severely impede the safety of pedestrians and the overall connectivity for non-automobile users. The geometric design of the traveled way and intersections has usually reflected the need to move traffic as quickly as possible. A paradigm shift needs to occur to reclaim the public right-of-way for pedestrians and bicyclists and create living streets.

Traveled way design in this chapter is defined as the part of the street right-of-way between the two faces of curbs and can include parking lanes, bicycle lanes, transit lanes, general use travel lanes, and medians. The design of the traveled way is critical to the design of the entire street right-of-way because it affects not just the users in the traveled way, but those using the entire right-of-way, including the areas adjacent to the street. As a note on terminology, “traveled way” in this document is more or less the equivalent of “roadway” in most conventional design manuals: the curb-to-curb portion of a curbed street.



*Wide, uninviting street
(Credit: Dan Burden)*

ESSENTIAL PRINCIPLES OF TRAVELED WAY DESIGN

The following key principles should be kept in mind for a well-designed traveled way:

- **Design to accommodate all users.** Street design should accommodate all users of the street, including pedestrians, bicyclists, transit users, automobiles, and commercial vehicles. A well-designed traveled way provides appropriate space for all street users to coexist.
- **Design using the appropriate speed for the surrounding context.** The right design speed should respect the desired role and responsibility of the street, including the type and intensity of land use, urban form, the desired activities on the sidewalk, such as outdoor dining, and the overall safety and comfort of pedestrians and bicyclists. The speed of vehicles impacts all users of the street and the livability of the surrounding area. Lower speeds reduce crashes and injuries.
- **Design for safety.** The safety of all street users, especially the most vulnerable users (children, the elderly, and disabled) and modes (pedestrians and bicyclists) should be paramount in any design of the traveled way. The safety of streets can be dramatically improved through appropriate geometric design and operations.



Senior citizens need more time to cross the street (Credit: Ryan Snyder)

Building on the momentum of complete streets that have been successfully implemented in different parts of the nation and around the world, there is a strong need for Los Angeles County to retrofit existing streets and create new types of street environments that reflect the values and desires of all users. This chapter discusses different factors affecting traveled way design. Individual geometric design elements such as lane width and sight distance are examined in greater detail. The benefits and constraints of each element are examined and the appropriate location and correct use of each element is defined to maximize the creation of living streets. Finally, a case study of La Jolla Boulevard in San Diego demonstrates the benefits of well-designed traveled ways.

FACTORS AFFECTING STREET DESIGN

Users

Pedestrians

Walking is the most basic mode of transportation, yet pedestrians are often ignored in roadway design. Certain areas generate high pedestrian activity, such as downtowns, residential, commercial, and entertainment areas, and schools. Yet even in areas of low pedestrian activity, such as along commercial strip-developed arterials, pedestrian needs and safety must be addressed, as drivers usually don't expect pedestrians, who are more vulnerable if a crash occurs. Much of this is due to speed. As speeds increase, drivers are less attentive to what is happening on the side of the road, reaction time is increased, and the pedestrian has a higher chance of dying or becoming severely injured in case of a crash.

Most pedestrian crashes occur when a person crosses the road, and the most common crash type is a conflict between a crossing pedestrian and a turning vehicle at an intersection.

But designing for pedestrians should not focus primarily on avoiding crashes; the goal of roadway and intersection design should be to create an environment that is conducive to walking, where people can walk along and cross the road, where the roadside becomes a place where people want to be. The two most effective methods to achieve these goals are to minimize the footprint dedicated to motor vehicle traffic and to slow down the speed of moving traffic. This approach allows the designer to use many features that enhance the walking environment, such as trees, curb extensions, and street furniture, which

in turn slow traffic: a virtuous cycle. All streets should have sidewalks except for rural roads and shared-space streets.

See Chapter 6, “Universal Pedestrian Access,” for specifics of sidewalk design and Chapter 7, “Pedestrian Crossings,” for specifics of pedestrian crossings.

Bicyclists

All streets should be designed with the expectation that bicyclists will use them. This does not mean every street needs a dedicated bicycle facility, nor will every road accommodate all types of bicyclists. Minimizing the footprint dedicated to motor vehicle traffic and slowing down the speed of moving traffic benefits bicyclists. Chapter 8, “Bikeway Design,” describes in greater detail the various types of bikeways and their application. Ideally, all multi-lane streets should have bike lanes. On multi-lane streets where bike lanes aren’t feasible because of space constraints, other bikeway treatments should be applied.

Public Transportation

Designing for transit vehicles on roadways takes into consideration many factors. Buses have operational characteristics that resemble trucks - they usually operate in mixed traffic, they stop and start often for passengers, and they must be accessible to people boarding the bus. The consequences for roadway design include lane width (in most cases buses can operate safely in travel lanes designed for passenger cars), intersection design (turning radius or width of channelization lane), signal timing (often adjusted to give transit an advantage—queue jumping), pedestrian access (crossing the street at bus stops), sidewalk design (making room for bus shelters in the furniture zone), and bus stop placement and design (farside/nearside at intersections, bus pullouts, or bulb outs).

Chapter 9, “Transit Accommodations,” describes in greater detail these and other design and operational considerations. Where express bus service or Bus Rapid Transit is provided, exclusive bus lanes are desirable. These have unique operating characteristics that are beyond the scope of this manual.

Design Vehicles

The design vehicle influences several geometric design features including lane width, corner radii, median nose design, and other intersection design details. Designing for a larger vehicle than necessary is undesirable, due to the potential negative impacts larger dimensions may have on pedestrian crossing distances and the speed of turning vehicles. On the other hand, designing for a vehicle that is too small can result in operational problems if larger vehicles frequently use the facility.

For design purposes, the WB-40 (wheel-base 40 feet) is appropriate unless larger vehicles are more common. On bus routes and truck routes, designing for the bus (CITY-BUS or similar) or large truck (either the WB-50 or WB-62FL design vehicle) may be appropriate, but only at intersections where these vehicles make turns. For example, for intersection geometry design features such as corner radii, different design vehicles should be used for each intersection or even each corner, rather than a “one-size-fits-all” approach, which results in larger radii than needed at most corners. The design vehicle should be accommodated without encroachment into opposing traffic lanes. It is generally acceptable to have encroachment onto multiple same-direction traffic lanes on the receiving roadway.

Furthermore, it may be inappropriate to design a facility by using a larger “control vehicle,” which uses the street infrequently, or infrequently makes turns at a specific location. An example of a control vehicle is a vehicle that makes no more than one delivery per day at a business. Depending on the frequency, by under designing the control vehicle can be allowed to encroach on opposing traffic lanes or make multiple-point turns.

Traffic Volume and Composition

Traffic volume data collection is an integral part of transportation planning and decision making. Traffic volume data are collected for various periods of the day depending on the purpose for which the data is used. For most analyses it is necessary to collect peak period and daily traffic. Peak period traffic could be further divided into morning (a.m.), mid-day (m.d.), and evening (p.m.) peak periods. Daily traffic data is also called average daily traffic (ADT). Other types of data collected are annual daily traffic, average annual daily traffic, average weekday traffic, hourly traffic (usually at intersections), and short-term

counts as required. There are special types of traffic volume counts such as vehicle classification counts and average vehicle occupancy. The traffic volumes collected are also used for a variety of studies, including forecasting. Traffic volume on a segment of a road or at an intersection can be collected either manually or by using tubes.

The ADT volume is the most commonly collected traffic volume data. The ADT provides both the peak period traffic and the total daily traffic for analysis purposes. Typical ADT data for a central business district (CBD) will show an a.m., mid-day, and p.m. peak volume, which clearly indicates the typical usage of the CBD.

Vehicle classification counts are conducted on a daily basis to determine the types of vehicles using the roadway. The vehicle classification devices currently in use accurately record axle impulses, but do not provide consistent and accurate interpretation of axle impulses into classification of vehicles when vehicles (typically in urban areas) are traveling at speeds below 25 mph. The Federal Highway Administration (FHWA) has classified trucks into several categories based on the number of axles.

Turning movement volumes are collected at intersections to record the various turning movements. The collection of data on turning movements allows determining the level of service and making improvements to the intersection to reduce delay and idling for all vehicles. The data collected on traffic volumes and turning movements helps to determine the number of travel lanes needed.

Design Speed

The application of design speed for living streets is philosophically different than for conventional transportation practices. Traditionally, the approach for setting design speed is to use as high a design speed as practical. This has many negative effects. Speed kills places as well as people, and places efficiency over access. Because high design speeds reduce access to places on foot, they degrade the social and retail life of a street and devalue the adjacent land. Local economies thrive on attracting people.

In contrast to this approach, the goal for living streets is to establish a design speed that creates a safer and more comfortable environment for motorists, pedestrians, and bicyclists. This approach also increases access to adjacent land, thereby increasing its value, and therefore



*High auto level of service with low multi-modal level of service
(Credit: Dan Burden)*

is appropriate for the surrounding context. For living streets, design speeds of 20 to 35 mph are desirable. Alleys and narrow roadways intended to function as shared spaces may have design speeds as low as 10 mph. Design speed does not determine nor predict exactly at what speed motorists will travel on a roadway segment; rather, design speed determines which design features are allowable (or mandated). Features associated with high-speed designs, such as large curb radii, straight and wide travel lanes, ample clear zones (no on-street parking or street trees), guardrails, etc., degrade the walking experience and make it difficult to design living streets. In the end, the design of the road encourages high speeds and creates a vicious cycle. A slower design speed allows the use of features that enhance the walking environment, such as small curb radii, narrower sections, trees, on-street parking, curb extensions, and street furniture, which in turn slow traffic: a virtuous cycle.

Movement Types

The following movement types are used to describe the expected driver experience on a given street and the design speed for pedestrian safety and mobility established for each of these movement types. They are also used to establish the components and criteria for design of living streets.

- **Yield:** Drivers must proceed slowly and with extreme care and must yield in order to pass a parked car or approaching vehicle. This is the functional equivalent of traffic calming. With a design speed of less than 20 mph, this type should accommodate bicycling through the use of shared lanes.
- **Slow:** Drivers can proceed carefully with an occasional stop to allow a pedestrian to cross or another car to park. Drivers should feel uncomfortable exceeding design speed due to the presence of parked cars, a feeling of enclosure, tight turn radii, and other design elements. With a design speed of 20 to 25 mph, this type should accommodate bicycling through the use of shared lanes.
- **Low:** Drivers can expect to travel generally without delay at the design speed; street design supports safe pedestrian movement at the higher design speed. This movement type is appropriate for streets designed to traverse longer distances or that connect to higher intensity locations. With a design speed of 30 to 35 mph, this type can accommodate bicycling with the use of bike lanes.

Design speeds higher than 35 mph should not normally be used within communities, or in Transects T-3 and above. Speeds greater than 30 mph or 35 mph violate the principles of living streets.

Communities that have streets functioning at speeds greater than 35 mph may want to adopt a goal to re-design the corridor to reduce the speed to 35 mph or less. The increase in motorist travel time due to the speed reduction is usually insignificant because communities designed with living streets are generally compact. When the speed reduction cannot be achieved, measures to improve pedestrian safety for those crossing the corridor should be evaluated and installed when appropriate.

Multi-Modal Level of Service

Municipalities use qualitative assessments to describe the perceived service a street provides to the people using the facility. The quality of service has conventionally been obtained using Level of Service (LOS) measurements. LOS assesses delay for motorists along a roadway section or at a signalized intersection. The LOS is defined using letters

A to F, where LOS F denotes the greatest delay and LOS A no delay. The LOS is used to develop solutions to improve the existing system to achieve the desired LOS. This convention considers quality of service for only automobiles and other vehicles (commercial) using the roadway system. The Highway Capacity Manual (HCM) provides details of the LOS computations for roadways and intersections.

Since traveled ways are used by different modes, the multimodal level of service (MMLOS) was developed under National Cooperative Highway Research Program (NCHRP) project 3-70. The MMLOS was developed for urban streets and it is currently designed for analysis of steady state conditions during a specified analysis period. MMLOS applies to urban streets with all modes of travel (cars, pedestrians, transit, and bicycles) and assesses the impacts of facility design and operation on all users except for commercial vehicles. The MMLOS analysis provides a tool to predict travel perceptions of quality of service.

The MMLOS for the four modal usages is output as numerical ratings, which are converted into the traditional A to F letter grade system. Table 4.1 indicates the MMLOS letter grade equivalents of the numerical values obtained.



*High multi-modal level of service
(Credit: Ryan Snyder)*

Table 4.1 MMLOS Letter Grade Equivalents

MMLOS Modal Output	MMLOS Letter Grade
Model \leq 2.0	A
2.0 < Model \leq 2.75	B
2.75 < Model \leq 3.50	C
3.50 < Model \leq 4.25	D
4.25 < Model \leq 5.00	E
Model > 5.0	F

Source: NCHRP-Web Only Document 128: Multimodal level of service analysis for urban streets: User Guide, 2009.

Notes:

1. If any directional segment hourly volume/capacity ratio (v/c) exceeds 1.0 for any mode, that direction of street is considered to be operating at LOS F for that mode of travel for its entire length (regardless of the computed LOS).
2. If the movement of any mode is legally prohibited for a given direction of travel on the street, then the LOS for that mode is LOS "F" for that direction.

For conducting MMLOS it is necessary to select a roadway segment that has signalized intersections, transit usage, bicycle riders, and pedestrians. The segment could have 5 to 6 signals in the selected section. The data required for conducting MMLOS includes street geometrics, such as number of through lanes, width of lanes, median width, bike lane, shoulder width, parking lane width, sidewalk width, right turn lanes, transit stops, and signalized and un-signalized intersections. The methodology provides some basic default values for use, which can be found in the reference provided at the end of this chapter.

By conducting an MMLOS analysis of existing roadway segments, the agency will be able to identify the deficiency in the system for all the modes. Using the results to change the analyzed street segment will improve the system for all users. The result should lead to very different decisions than would be made under the traditional LOS assessment. Using LOS as the measurement, municipalities typically remedy low

LOS by widening streets, flaring intersections, and other measures designed to improve the flow of autos. In contrast, applying MMLOS can lead to improvements for pedestrians, bicyclists, and transit users.

Access Management

A major challenge in street design is balancing the number of access points to a street. As discussed in Chapter 3, “Street Networks and Classifications,” there are many benefits of well-connected street networks. On the other hand, most conflicts between users occur at intersections and driveways. The presence of many driveways in addition to the necessary intersections creates many conflicts between vehicles entering or leaving a street and bicyclists and pedestrians riding or walking along the street. When possible, new driveways should be minimized and old driveways should be eliminated or consolidated, and raised medians should be placed to limit left turns into and out of driveways.

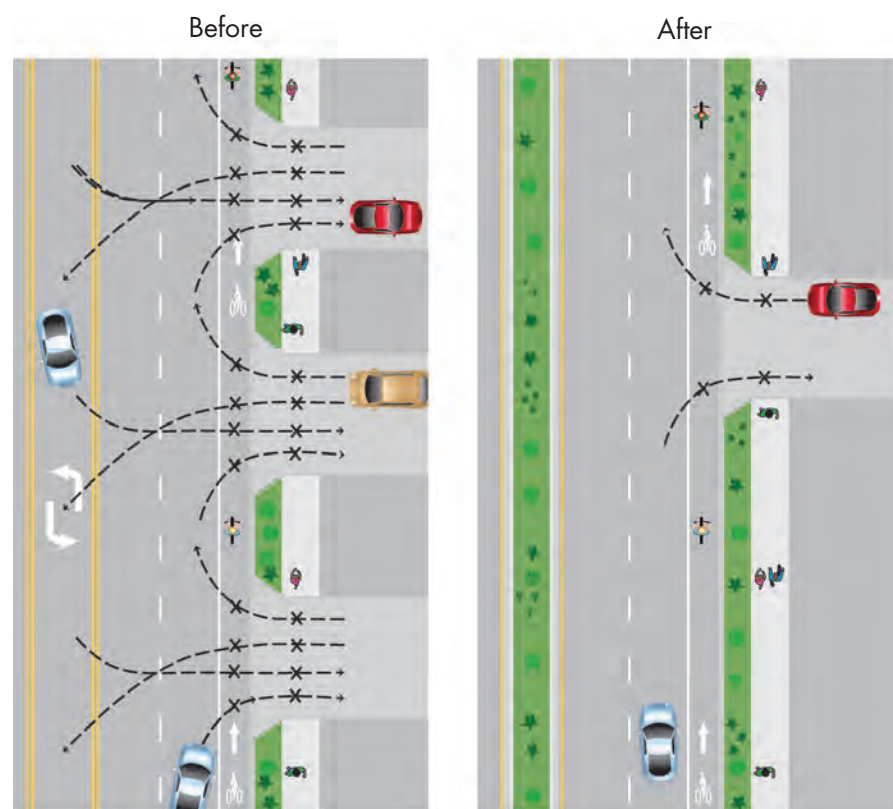

*Adding medians and consolidating driveways to manage access
(Credit: Michele Weisbart)*

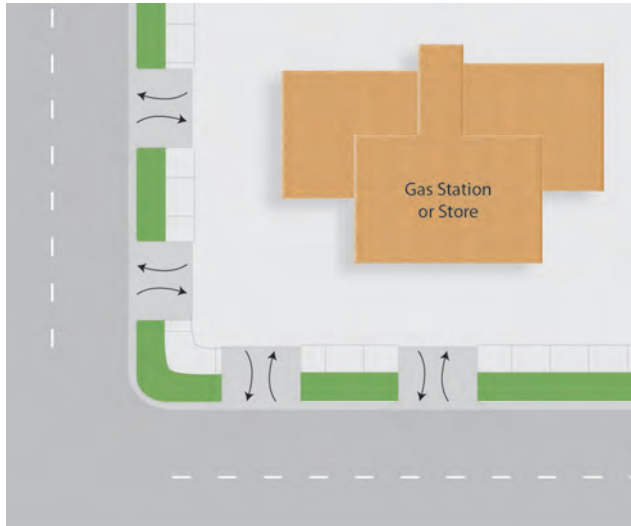

Corner with many wide driveways
(Credit: Michele Weisbart)

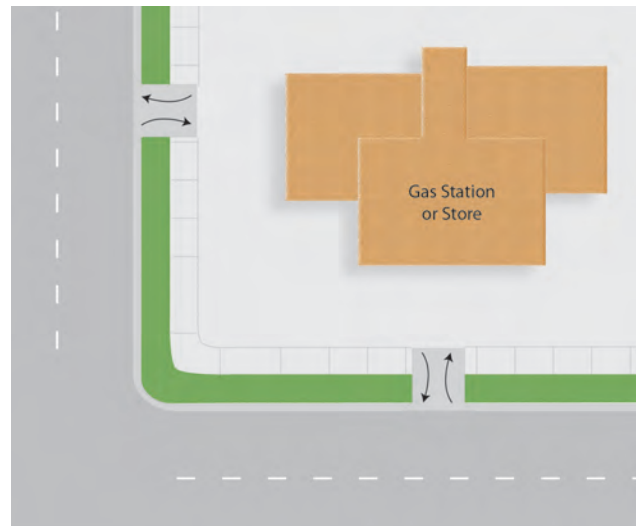

Reconstructed corner with fewer, narrower driveways
(Credit: Michele Weisbart)

Access management through limiting driveways and providing raised medians has many benefits:

- The number of conflict points is reduced, especially by replacing center-turn lanes with raised medians since left turns by motorists account for a high number of crashes with bicyclists and pedestrians.
- Pedestrian crossing opportunities are enhanced with a raised median.
- Universal access for pedestrians is easier, since the sidewalk is less frequently interrupted by driveway slopes.
- Fewer driveways result in more space available for higher and better uses.
- Improved traffic flow may reduce the need for road widening, allowing part of the right-of-way to be recaptured for other users.

Possible Negatives of Access Management

The following possible negative effects of management should be considered and addressed:

- Streamlining a street may increase motor vehicle speeds and volumes, which can be detrimental to other users.
- Reduced access to businesses may require out-of-direction travel for all users, including walkers and bicyclists.
- Concrete barriers and overly-landscaped medians act as barriers to pedestrian crossings. Medians should be designed with no more than normal curb height and with landscaping that allows pedestrians to see to the other side.
- Adjacent land uses can experience decreased access. This can impact businesses as well as residents. Careful planning of access management considers this.

CROSS SECTIONAL ELEMENTS

Living street design treats streets as part of the public realm. The street portion of the public realm is shaped by the features and cross section elements used in creating the street. Attention to what features are included, where they are placed, and how the cross section elements are assembled is necessary.

On-Street Parking

On street parking can be important in the urban environment for the success of the retail businesses that line the street and to provide a buffer for pedestrians and help calm traffic speeds. On-street parking occupies about half the surface area per car compared to off-street, which requires driveways and aisles for access and maneuvering. However, cities should manage demand for on-street parking by charging market-rate prices. Free or underpriced parking encourages people to drive instead of taking transit, biking, or walking. Parking expert Donald Shoup recommends setting variable parking prices to target a 15 percent vacancy rate for curb parking. In addition to encouraging people to curtail driving, it also creates turnover that benefits retailers by making convenient parking available for short shopping trips.



*Reverse-in angled parking: Boise, ID
(Credit: Dan Burden)*



*Parking assist lane
(Credit: Michael Wallwork)*

Where angle parking is proposed for on-street parking, designers should consider the use of reverse-in angle (or front out) parking in lieu of front-in angled parking. Motorists pulling out of reverse-in angled parking can better see the active street they are entering. This is especially important to bicyclists. Moreover, people exiting cars do so on the curb side and aren't likely to step into an active travel lane.

Another tool for on-street parking is the park assist lane. Often when on-street parking is provided on busy roads, drivers find it difficult to enter and leave their parked vehicle. Where space is available, consideration should be given to adding a park assist lane between the parking lane and travel way to provide 3 feet of space so car doors can be opened and vehicles can enter or depart with a higher degree of safety and less delay. Bike lanes can serve this function as well. Parking assist lanes also narrow the feel of the travel lane and slow traffic.

Table 4.2 below details recommended parking lane widths for slow and low movement types.

Table 4.2 Parking Lane Widths

Movement Type	Design Speed	Parking Lane Width
Slow	20-25 mph	Angle: 16.5' (60°); 15' (45°)
Slow	20-25 mph	Parallel: 7 feet
Low	30-35 mph	Parallel: 7-8 feet

Bicycle Facilities

Bicycle facilities within the traveled way may include bicycle lanes, bicycle boulevards, other types of shared roadways (with or without shared lane markings), and cycle tracks. See Chapter 8, “Bikeway Design,” for design recommendations for these facilities.

Transit Facilities

Transit accommodations within the traveled way may include dedicated transit lanes, bus bulbs, bus pullouts, and other features. See Chapter 9, “Transit Accommodations,” for design recommendations for these features.

Travel Lanes

Travel lane widths should be provided based on the context and desired speed for the area that the street is located in. Table 4.3 shows lane widths and the associated speeds that are appropriate. In low speed urban environments, lane widths are typically measured to the curb face instead of the edge of the gutter pan. Consequently, when curb sections with gutter pans are used, the vehicle, bike, and parking lane all include the width of the gutter pan.

In order for drivers to understand how fast they should drive, lane widths have to create some level of driver discomfort when driving too fast. The presence of on-street parking is important in achieving the speeds shown in Table 4.3. When designated bike lanes or multi-lane configurations are used, there is more room for large vehicles, such as buses, to operate in, but car drivers will feel more comfortable driving faster than is desired.

*Below: Wide two-lane street
(Credit: Ryan Snyder)*

*Below, right: Narrow two-lane street
(Credit: Michael Ronkin)*



Table 4.3 Travel Lane Widths and Associated Design Speeds

Movement Type	Design Speed	Travel Lane Width
Yield	Less than 20 mph	N/A
Slow	20-25 mph	9** - 10 feet
Low	30-35 mph	10 - 11 *** feet

*Yield streets are typically residential two-way streets with parking on one or both sides. When the street is parked on both sides, the remaining space between parked vehicles (12 feet minimum) is adequate for one vehicle to pass through. Minimum width for a yield street with parking on both sides should be 26 feet curb face to curb face. Minimum width for a yield street with parking on one side should be 20 feet curb face to curb face, which allows for two 10-foot lanes when the street is not parked.

**9' requires a design exemption.

***Generally, 10-foot lanes are preferred. Where heavy bus or truck traffic exists, 11-foot lanes may be considered.

Alleys can be designed as one-way or two-way. Right-of-way width should be a minimum of 20 feet with no permanent structures located within the right-of-way that would interfere with vehicle access to garages or parking spaces, access for trash collection, and other operational needs. Pavement width should be a minimum of 12 feet. Coordination with local municipalities on operational requirements is essential to ensure that trash collection and fire protection services can be completed.

Turn Lanes

The need for turn lanes for vehicle mobility should be balanced with the need to manage vehicle speeds and the potential impact on the border width such as sidewalk width. Turn lanes tend to allow higher speeds to occur through intersections, since turning vehicles can move over to the turn lane, allowing the through vehicles to maintain their speed.

Left-turn lanes are considered to be acceptable in an urban environment since there are negative impacts to roadway capacity when left turns block the through movement of vehicles. Sometimes just a left-turn pocket is sufficient, just long enough for one or two cars to wait out of

traffic. The installation of a left-turn lane can be beneficial when used to perform a road diet such as reducing a four lane section to three lanes with the center lane providing for turning movements.

In urban places, normally no more than one left-turn lane should be provided. While right turns from through lanes may delay through movements, they also create a reduction in speed due to the slowing of turning vehicles. The installation of right-turn lanes increases the crossing distance for pedestrians and the speed of vehicles; therefore, exclusive right turn lanes should rarely be used except at “T” intersections. When used, they should be mitigated with raised channelization islands. See Chapter 5, “Intersection Design,” for more details.

Medians

Medians used on urban streets provide access management by limiting left turn movements into and out of abutting development to select locations where a separate left turn lane or pocket can be provided. The reduced number of conflicts and conflict points decreases vehicle crashes, provides pedestrians with a refuge as they cross the road, and provides space for landscaping, lighting, and utilities. These medians are usually raised and curbed. Landscaped medians enhance the street or help to create a gateway entrance into a community.

Medians can be used to create tree canopies over travel lanes, contributing to a sense of enclosure. As shown in Table 4.4, medians vary in width. Recommended widths depend on available right-of-way and function. Because medians require a wider right-of-way, the designer must weigh the benefits of a median with the issues of pedestrian crossing: distance, speed, context, and available roadside width.



Well-designed street medians bring multiple benefits (Credit: Dan Burden)

Table 4.4 Median Types and Widths

Median Type	Minimum Width	Recommended Width
Median for access control	4 feet	6 feet
Median for pedestrian refuge	6 feet	8 feet
Median for trees and lighting	6 feet [1]	10 feet [2]
Median for single left-turn lane	10 feet [3]	10 feet [2]
Median for single left-turn lane and pedestrian refuge	16 feet [4]	16 feet

Table Notes

[1] Six feet measured curb face to curb face is generally considered the minimum width for proper growth of small caliper trees (less than 4 inches).

[2] Wider medians provide room for larger caliper trees and more extensive landscaping.

[3] A 10-foot lane provides for a turn lane without a concrete traffic separator.

[4] Includes a 10-foot turn lane and a 6-foot pedestrian refuge.

Sample Cross Sections

Municipalities that are developing new subdivisions or brand new streets through second-generation development (see Chapter 14, "Retrofitting Suburbia") can create new street standards based on the information above. Sample curb-to-curb cross sections for the basic street typologies are shown in the diagrams below. These are only samples; other cross sections using the above guidance are also acceptable. When adopting standards for new streets, local jurisdictions should also include the sidewalks as an integral part of the street and use the guidance provided in Chapter 6, "Universal Pedestrian Access." In built out places, rigid street standards are often impractical. Curb-to-curb widths are set, buildings exist and rights-of-way don't allow for adhering to full cross-section standards. Municipalities may want to reconfigure streets by reassigning space to make streets more closely meet the principles of living streets. In these cases, they can apply the principles along with the minimum and recommended widths given above. The following diagrams provide examples of how some of these apply.

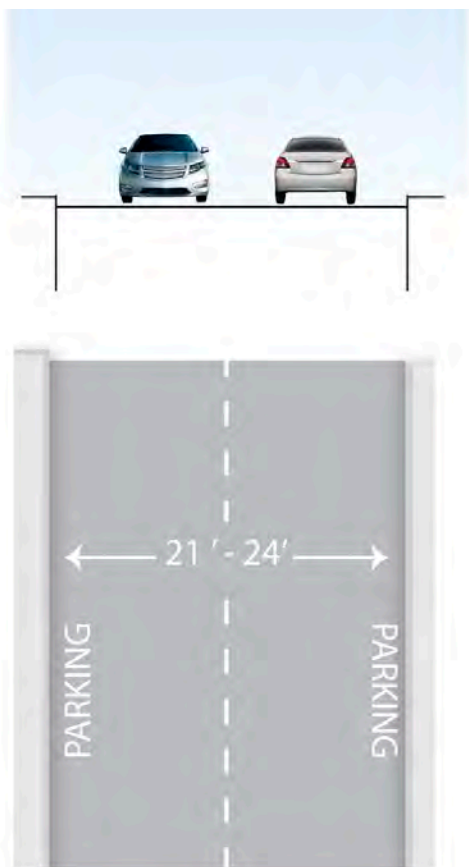

Residential street

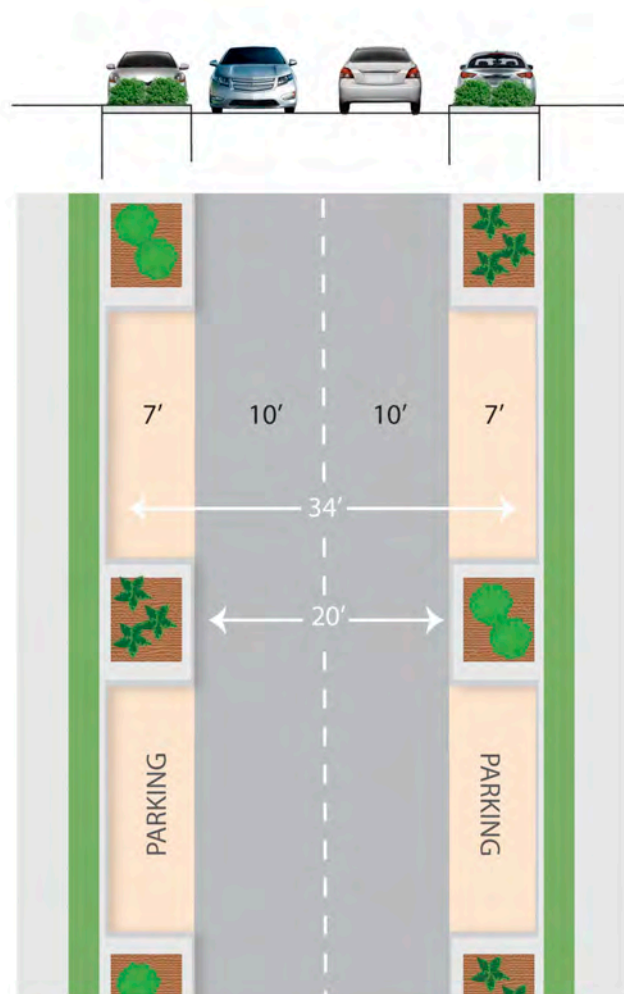

Residential street with inset parking

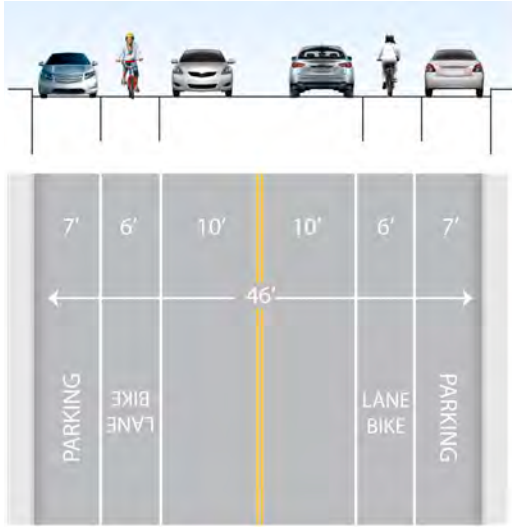

Avenue

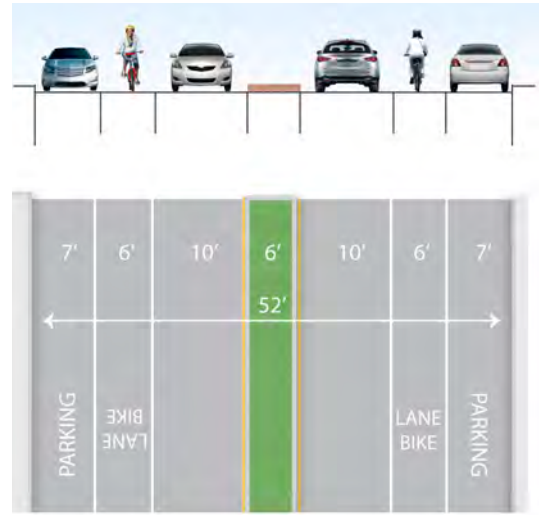

Avenue with median

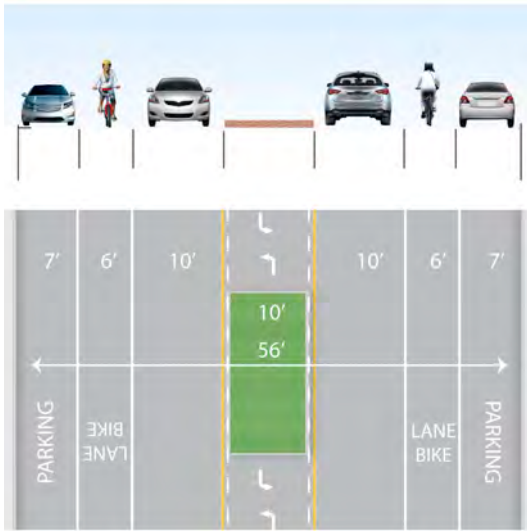

Avenue with medians interspersed with turn lanes

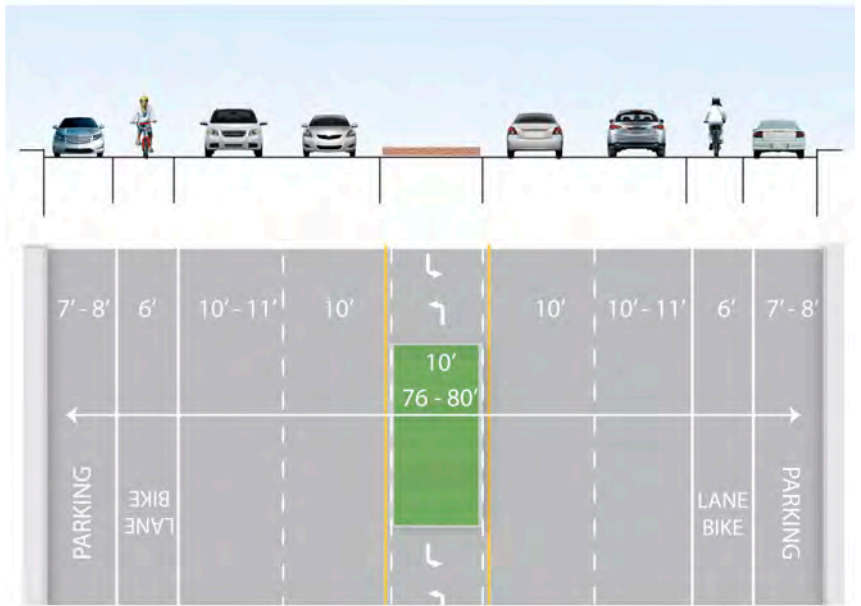

Boulevard

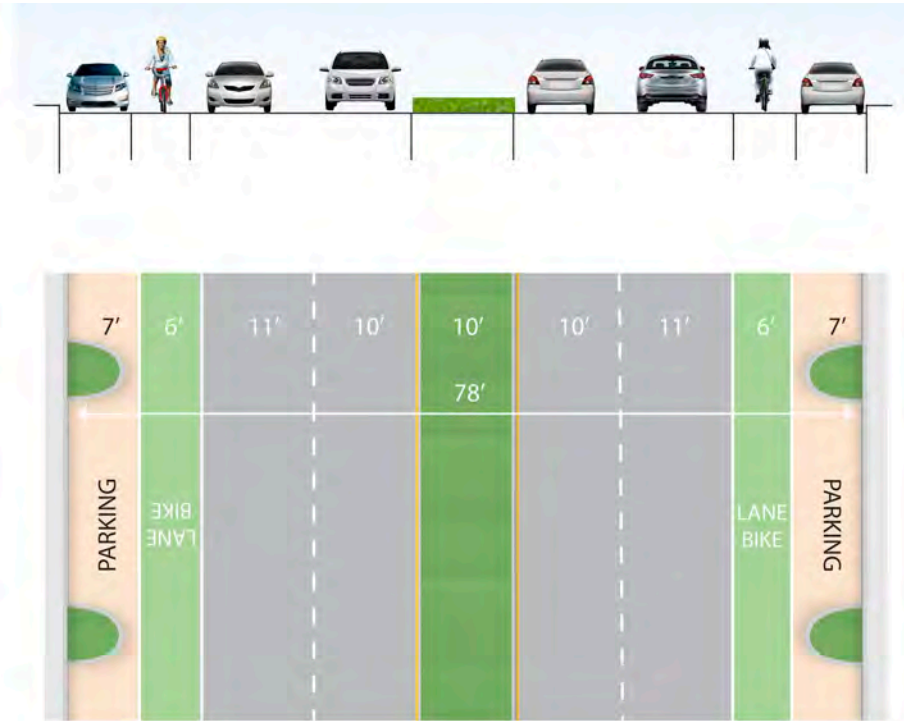

Boulevard with colored bike lanes and inset parking

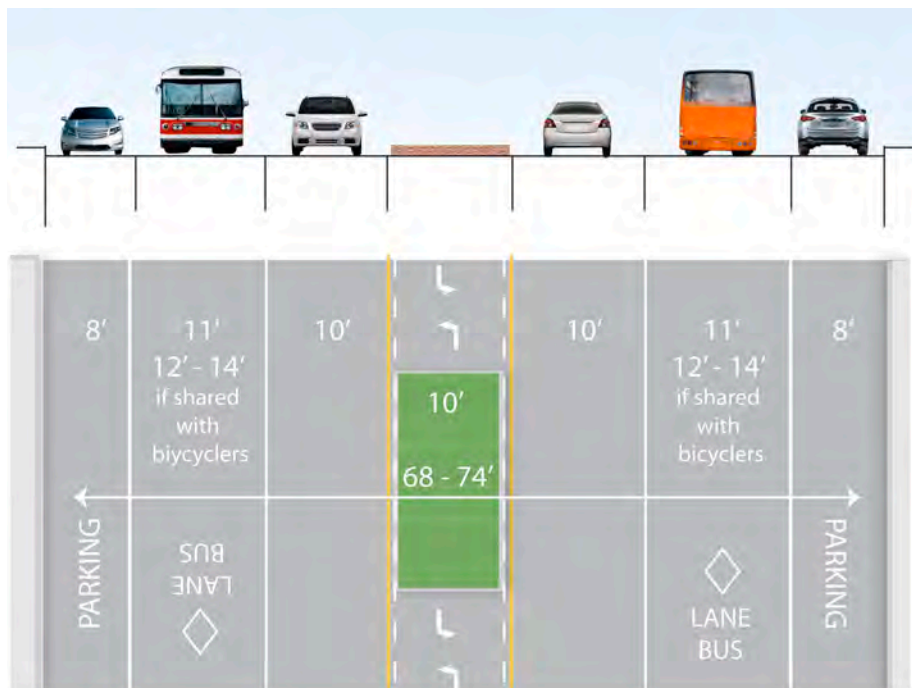

Boulevard with bus lanes

Sample standard street cross sections.
(Credit: Michele Weisbart)

In built out places, rigid street standards are often impractical. Curb-to-curb widths are set, buildings exist and rights-of-way don't allow for adhering to full cross-section standards. Municipalities may want to reconfigure streets by reassigning space to make streets more closely meet the principles of living streets. In these cases, they can apply the principles along with the minimum and recommended widths given above. The following diagrams provide examples of how some of these apply.

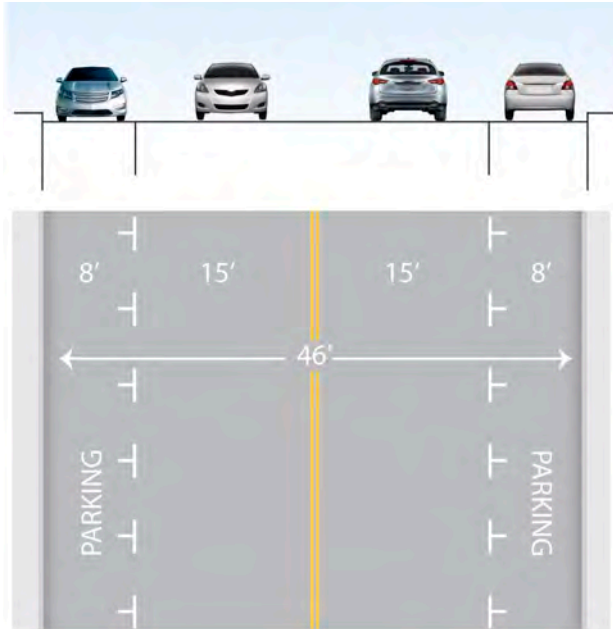

Existing 46'-wide avenue

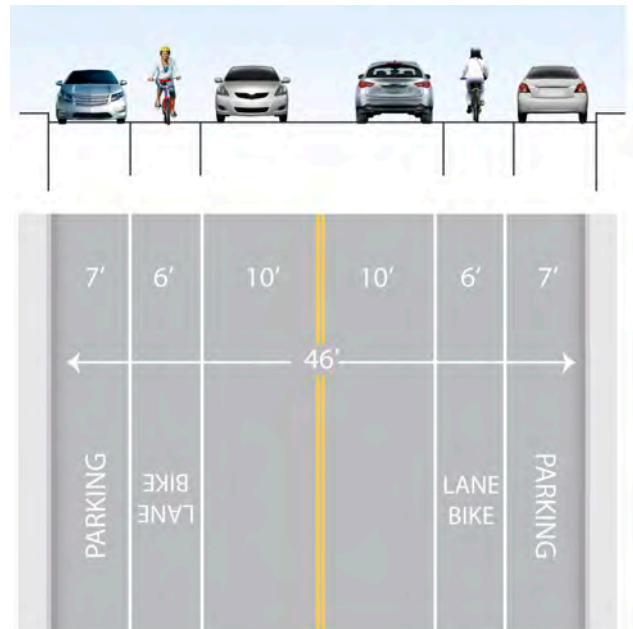

Restripe to add bike lanes

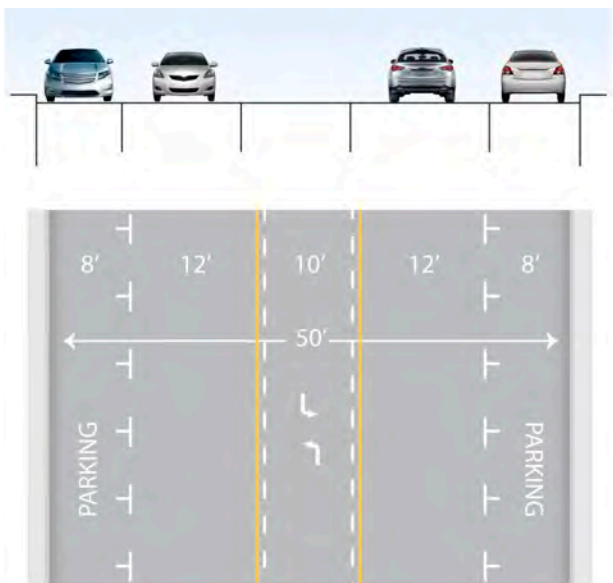

Existing 50' avenue

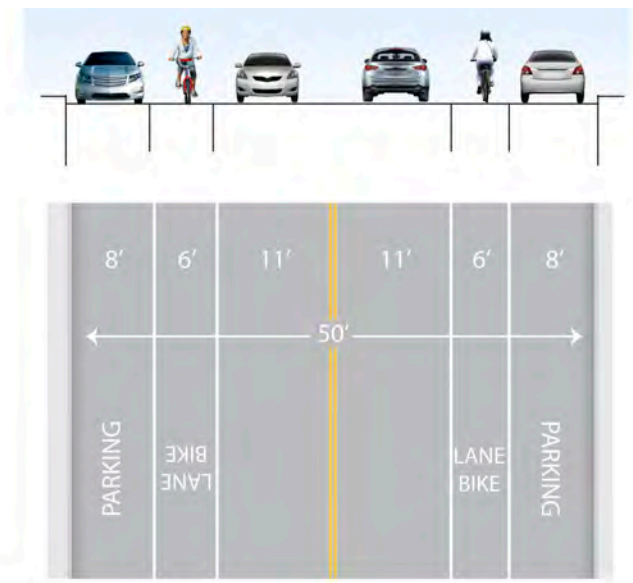

Option 1: Restripe to add bike lanes

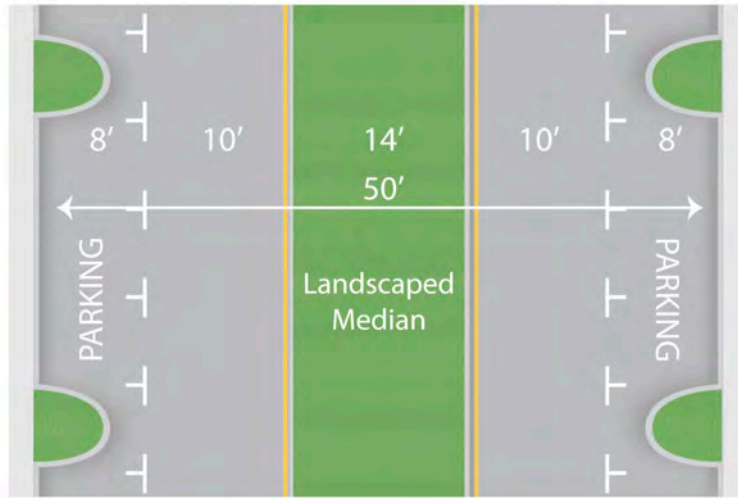
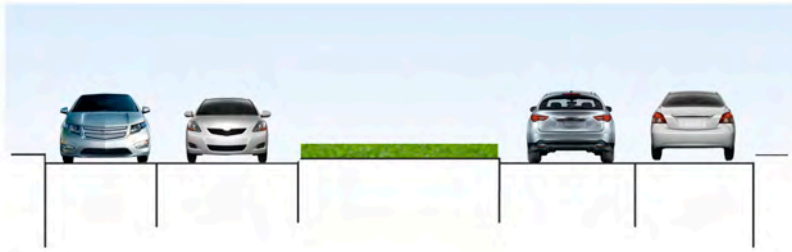

Option 2: Add median

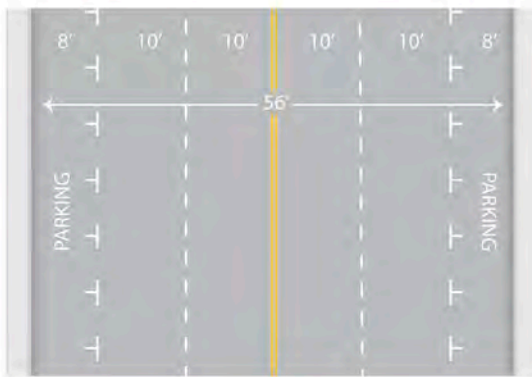

Existing 56'-wide main street

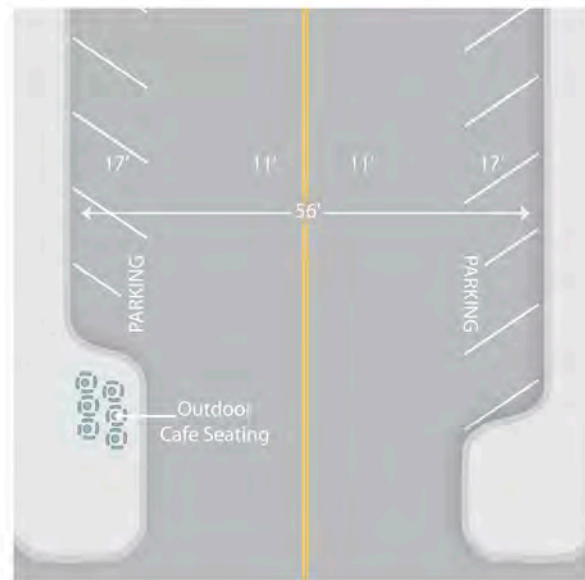

Reduce travel lanes and add reverse-in angled parking with curb extensions large enough for café seating

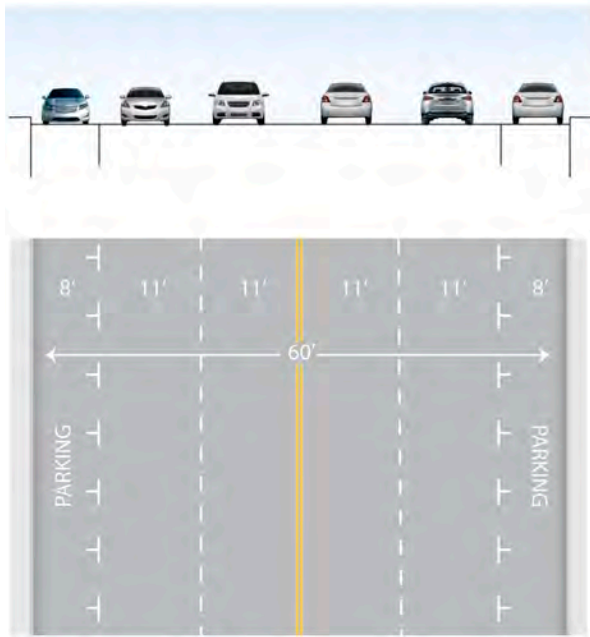

Existing 60'-wide avenue or boulevard

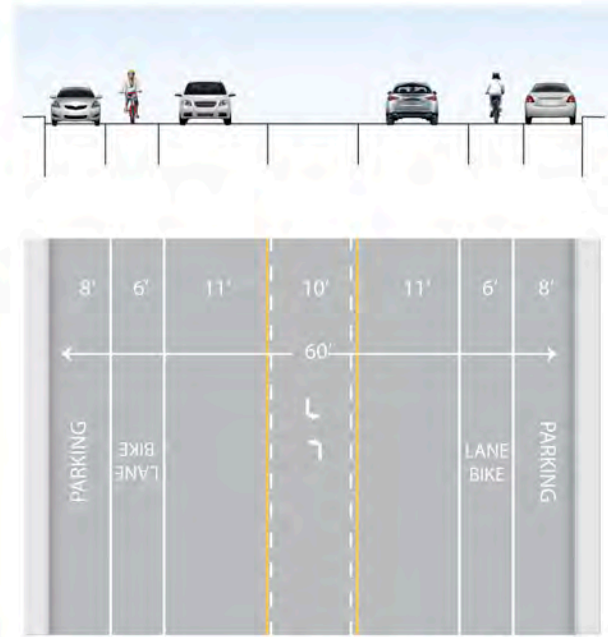

Option 1: Reduce travel lanes and add bike lanes



Option 2: Reduce travel lanes and add median islands interspersed with turn lanes; add interspersed landscaped curb extensions to inset parking

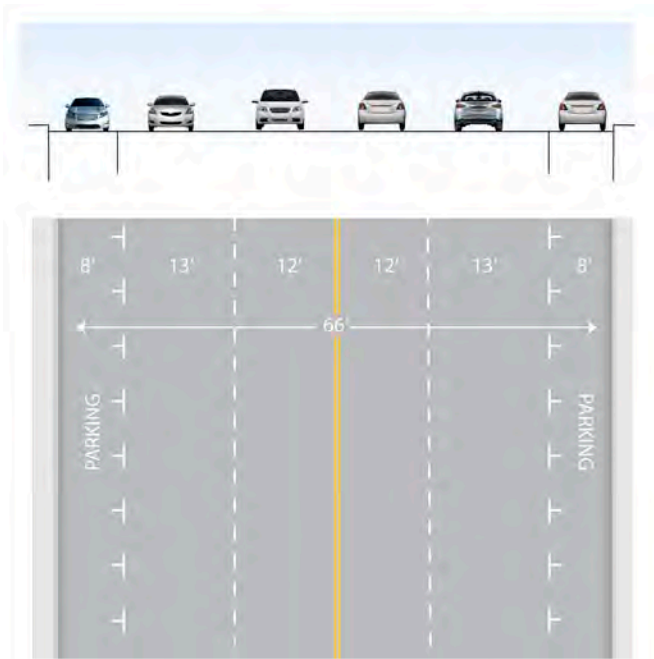

Existing 66'-wide boulevard

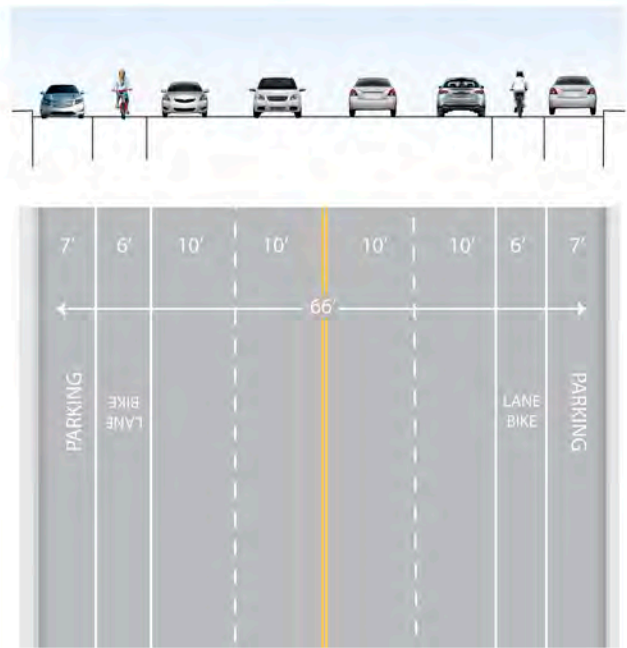

Narrow travel lanes to add bike lanes

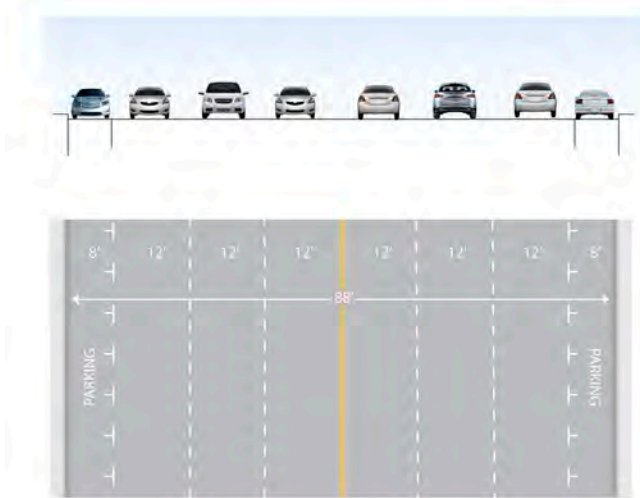

Existing 88'-wide boulevard

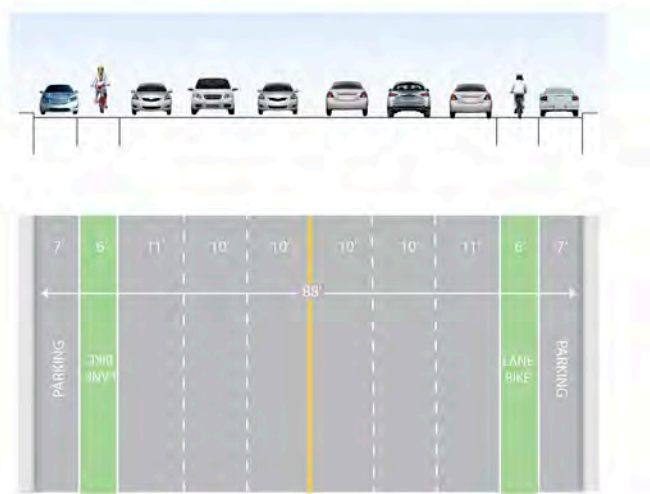

Narrow travel lanes to add colored bike lanes

OTHER GEOMETRIC DESIGN ELEMENTS

Vertical Alignment

The American Association of State Highway and Transportation Officials (AASHTO) Geometric Design of Highways and Streets manual (AASHTO Green Book) provides acceptable values for designing vertical curves for living streets. The values used in design of vertical curve design should be selected based on the design speed appropriate for the context of the street. Using higher values can contribute to increased vehicle speeds and may require increased modification to the natural terrain, increasing negative impacts to the natural environment.

Horizontal Alignment

The AASHTO Green Book provides appropriate values for designing horizontal curves for living streets. The values used in horizontal curve design should be selected based on the design speed appropriate for the context of the street. Using higher values can contribute to increased vehicle speeds and also impacts the character of the street. Larger horizontal curves also create a more “suburban” or “rural” highway feel.

Sight Distance

Stopping Sight Distance

The AASHTO Green Book provides appropriate values for designing stopping sight distance for living streets. The 2004 AASHTO Guide for Achieving Flexibility in Highway Design is based on the latest research concerning the establishment of stopping sight distance. The document states that the established values for stopping sight distance are very conservative and provide adequate flexibility without creating increased crash risk. Consequently, appropriate design speed selection is critical to avoid overly negative impacts such as unnecessarily limiting on-street parking and tree planting.

Intersection Sight Distance

Intersection sight distance should be calculated in accordance with the AASHTO Green Book using the design speed appropriate for the street being evaluated. When executing a crossing or turning maneuver onto a street after stopping at a stop sign, stop bar, or crosswalk, drivers will move slowly forward to obtain sight distance (without intruding into the crossing travel lane) stopping a second time as necessary. Therefore, when curb extensions are used or on-street parking is in place, the vehicle can be assumed to move forward on the second step movement, stopping just shy of the travel lane, increasing the driver's potential to see further than when stopped at the stop bar. As a result, the increased sight distance provided by the two step movement allows parking to be located closer to the intersection.

Horizontal Clearance/Clear Zone

Horizontal clearance is the lateral distance from a specified point on the roadway, such as the edge of the travel lane or face of the curb, to a roadside feature or object. The clear zone is the relatively flat unobstructed area that is to be provided for safe use by errant vehicles.

In urban areas, horizontal clearance based on clear zone requirements for rural and suburban highways is not practical because urban areas are characterized by more bicyclists and pedestrians, lower speeds, more dense abutting development, closer spaced intersections and accesses to property, higher traffic volumes, and restricted right-of-way. Therefore, streets with curbs and gutters in urban areas do not have sufficiently wide roadsides to provide clear zones. Consequently, while there are specific horizontal clearance requirements for these streets, they are based on clearances for normal operation and not based on maintaining a clear roadside for errant vehicles. The minimum horizontal clearance is 1.5 feet measured from the face of the curb. This is primarily intended for sign posts and poles, so they aren't hit by large vehicles with overhangs maneuvering close to the curb.

Traveled Way Lighting

Pedestrians are disproportionately hit when visibility is poor: at dusk, night, and dawn. Many crossings are not well lit. Providing illumination or improving existing lighting increases nighttime safety at intersections and midblock crossings, as motorists can better see pedestrians. Pedestrian scale lighting along sidewalks provides greater security, especially for people walking alone at night.

Transit stops require both kinds of lighting: strong illumination of the traveled way for safer street crossing, and pedestrian scale illumination at the stop or shelter for security.

FHWA-HRT-08-053, Informational Report on Lighting Design for Midblock Crosswalks, (April 2008) is a very good resource. It also contains very useful information about lighting design for pedestrians at intersections.

If bus stops are present between roadway sections, it is necessary to illuminate the roadway and the bus stop. The lighting at the bus stop is essential to provide safety for transit users. Bus stops have high pedestrian activity; therefore, it is necessary to provide adequate lighting at these facilities.

MODEL PROJECT

La Jolla

La Jolla Boulevard in the Bird Rock neighborhood of San Diego is an example of the conversion of a five-lane road. Due to parents' complaints that they had to drive their children across the road, a community charrette was organized in 2002. As a result, a new concept was developed that included a median, one 11-foot travel lane in each direction, park assist lanes next to the parallel parking lane on the east side, and a wider park assist lane next to the angled parking on the west side of the street. The five intersections that were controlled by two or four-way stop control and signals were converted to single lane roundabouts.

The project was opened in stages and completed in August 2008. Although the traffic volumes have decreased because of the recession from 22,000 vehicles per day to 17,000 vehicles per day, the pedestrian and bicycle volumes have increased enormously (City of San Diego traffic counts and traffic webcam, 2010).



La Jolla Boulevard intersection before and after roundabout: San Diego, CA (Credit: Michael Wallwork)

Chapter 5. INTERSECTION DESIGN

INTRODUCTION.....	5-2
ESSENTIAL PRINCIPLES OF INTERSECTION DESIGN.....	5-2
INTERSECTION GEOMETRY.....	5-3
Intersection Skew.....	5-3
Corner Radii.....	5-5
Curb Extensions.....	5-6
Crosswalk and Ramp Placement.....	5-8
On-Street Parking Near Intersections.....	5-10
Right Turn Channelization Islands.....	5-10
YIELD AND STOP CONTROLLED INTERSECTIONS.....	5-12
SIGNALIZED INTERSECTIONS.....	5-13
Operational Design.....	5-14
Phasing.....	5-14
ROUNDBABOUTS.....	5-19
Advantages and Disadvantages.....	5-20
General Design Elements of Roundabouts.....	5-22
Roundabout Design Criteria.....	5-23
Operations and Analysis.....	5-24
Single-Lane Roundabouts.....	5-24
Multi-Lane Roundabouts.....	5-25
Mini-Roundabouts.....	5-27
Neighborhood Traffic Circles.....	5-28



INTRODUCTION

Most conflicts between roadway users occur at intersections, where travelers cross each other's path. Good intersection design indicates to those approaching the intersection what they must do and who has to yield. Exceptions to this include places where speeds are low (typically less than 18 mph) or where a shared space design ("naked streets") causes users to approach intersections with caution. Conflicts for pedestrians and bicyclists are exacerbated due to their greater vulnerability, lesser size, and reduced visibility to other users.

This chapter describes design considerations in intersection geometry and intersection signalization, as well as roundabouts and other features to improve safety, accessibility, and mobility for all users. The benefits and constraints of each feature are examined and the appropriate use and design of each feature are described.

ESSENTIAL PRINCIPLES OF INTERSECTION DESIGN

The following principles apply to all users of intersections:

- Good intersection designs are compact.
- Unusual conflicts should be avoided.
- Simple right-angle intersections are best for all users since many intersection problems are worsened at skewed and multi-legged intersections.
- Free-flowing movements should be avoided.
- Access management practices should be used to remove additional vehicular conflict points near the intersection.
- Signal timing should consider the safety and convenience of all users and should not hinder bicycle or foot traffic with overly long waits or insufficient crossing times.

Intersection geometry is a critical element of intersection design, regardless of the type of traffic control used. Geometry sets the basis for how all users traverse intersections and interact with each other. The principles of intersection geometry apply to both street intersections and freeway on- and off-ramps.

INTERSECTION GEOMETRY



Lively intersection (Credit: Dan Burden)

Intersection Skew

Skewed intersections are generally undesirable and introduce the following complications for all users:

- The travel distance across the intersection is greater, which increases exposure to conflicts and lengthens signal phases for pedestrians and vehicles.
- Skews require users to crane their necks to see other approaching users, making it less likely that some users will be seen.
- Obtuse angles encourage speeding.

To alleviate the problems with skewed intersections, several options are available:

- Every reasonable effort should be made to design or redesign the intersection closer to a right angle. Some right-of-way may have to be purchased, but this can be offset by the larger area no longer needed for the intersection, which can be sold back to adjoining property owners or repurposed for a pocket park, rain garden, greenery, etc.

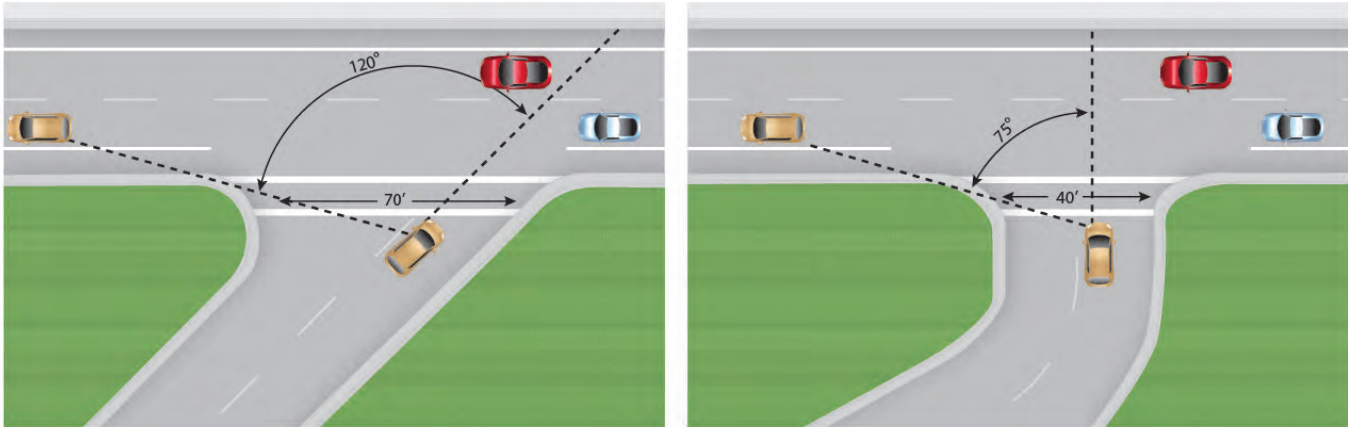

Realigning the skewed intersection in the graphic on the left to the right-angle connection in the graphic on the right results in less exposure distance and better visibility for all users (Credit: Michele Weisbart)

- Pedestrian refuges should be provided if the crossing distance exceeds approximately 40 feet.
- General use travel lanes and bike lanes may be striped with dashes to guide bicyclists and motorists through a long undefined area.

Multi-leg intersections (more than two approaching roadways) are generally undesirable and introduce the following complications for all users:

- Multiple conflict points are added as users arrive from several directions.
- Users may have difficulty assessing all approaches to identify all possible conflicts.
- At least one leg will be skewed.
- Users must cross more lanes of traffic and the total travel distance across the intersection is increased.

To alleviate the problems with multi-leg intersections, several options are available:

- Every reasonable effort should be made to design the intersection so there are no more than four legs. This is accomplished by removing one or more legs from the major intersection and creating a minor intersection further up or downstream.
- As an alternative, one or more of the approach roads can be closed to motor vehicle traffic, while still allowing access for pedestrians and bicyclists.
- Roundabouts should be considered.

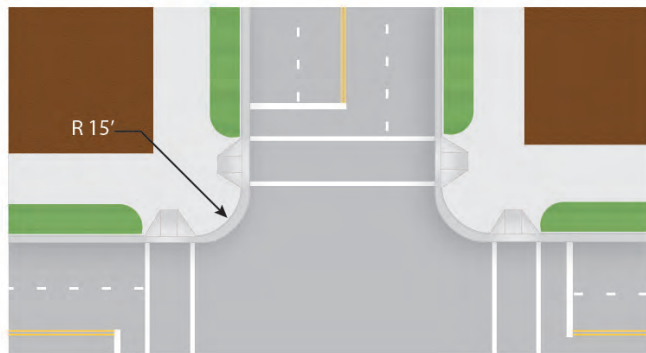
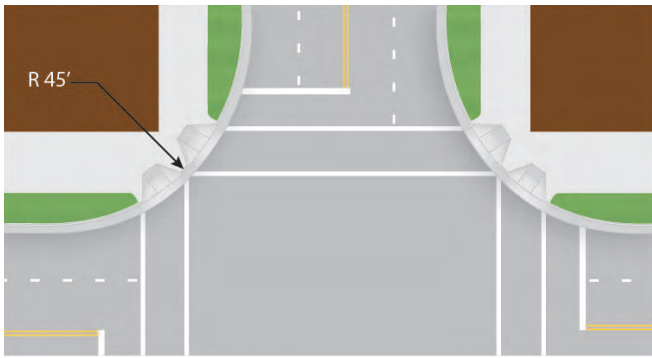

Tighter corner radii reduce crossing distance and slow turning traffic (Credit: Michele Weisbart)

- Pedestrian refuges should be created if the crossing distance exceeds approximately 40 feet.
- General use travel lanes and bike lanes may be striped with dashes to guide bicyclists and motorists through a long undefined area.

Corner Radii

This intersection geometry feature has a significant impact on the comfort and safety of non-motorized users. Small corner radii provide the following benefits:

- Smaller, more pedestrian-scale intersections resulting in shorter crossing distances
- Slower vehicular turning speeds
- Reduced pedestrian crossing distance and crossing time
- Better geometry for installing perpendicular ramps for both crosswalks at each corner
- Simpler, more appropriate crosswalk placement, in line with the approaching sidewalks

When designing corner radii for complete streets, the default design vehicle should be the passenger (P) vehicle. Therefore, the default corner radius is 15 feet. Larger design vehicles should be used only where they are known to regularly make turns at the intersection, and corner radii should be designed based on the larger design vehicle traveling at crawl speed. In addition, designers should consider the effect that bicycle lanes and on-street parking have on the effective radius, increasing the ease with which large vehicles can turn.

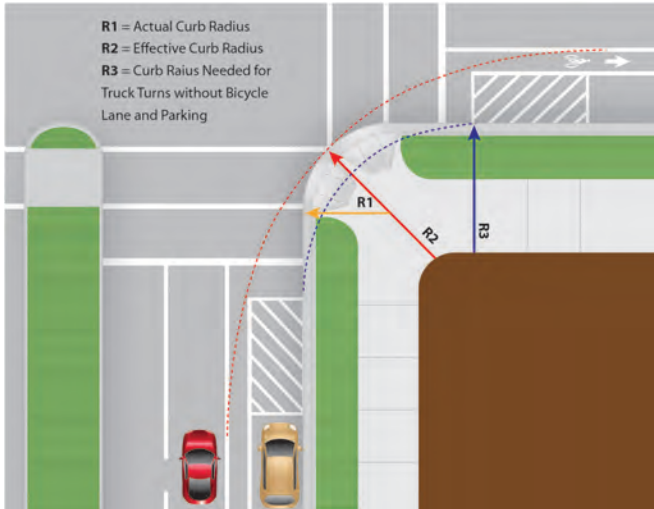

The effective corner radius controls turning speeds and the ability of large vehicles to turn (Credit: Michele Weisbart)

Encroachment by large vehicles is acceptable onto multiple receiving lanes. When a design vehicle larger than the passenger (P) vehicle is used, the truck or bus should be allowed to turn into all available receiving lanes. As described in Chapter 4, “Traveled Way Design,” larger, infrequent vehicles (the “control vehicle”) can be allowed to encroach on multiple departure lanes and partway into opposing traffic lanes.

Curb Extensions

Where on-street parking is allowed, curb extensions should be considered to replace the parking lane at crosswalks. Curb extensions should be the same width as the parking lane. The appropriate corner radius should be applied based on the guidance in the section above. Due to reduced road width, the corner radius on a curb extension may need to be larger than if curb extensions were not installed.

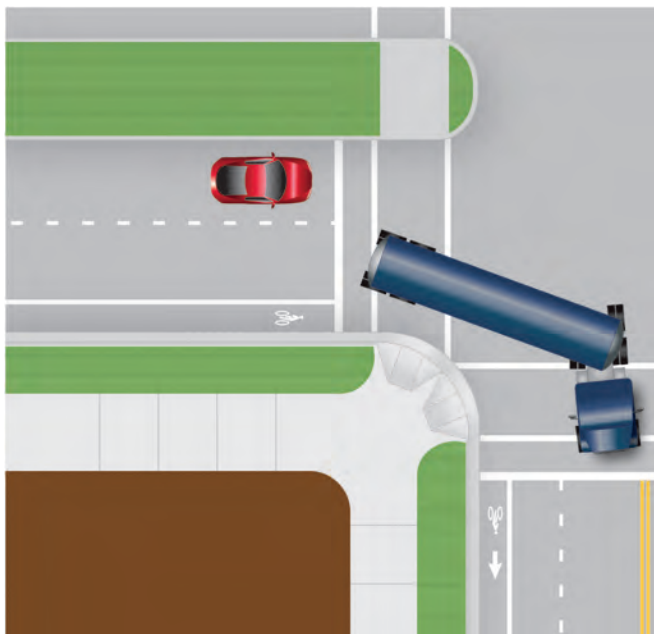

Corner radii can be kept smaller by allowing trucks and buses to turn into multiple receiving lanes (Credit: Michele Weisbart)

Curb extensions offer many benefits related to livability:

- Reduced pedestrian crossing distance resulting in less exposure to vehicles and shorter pedestrian clearance intervals at signals
- Improved visibility between pedestrians and motorists
- A narrowed roadway, which has a potential traffic calming effect
- Additional room for street furniture, landscaping, and curb ramps
- Slower turning vehicles
- Additional on-street parking potential due to improved sight lines at intersections. Since curb extensions allow pedestrians to walk out

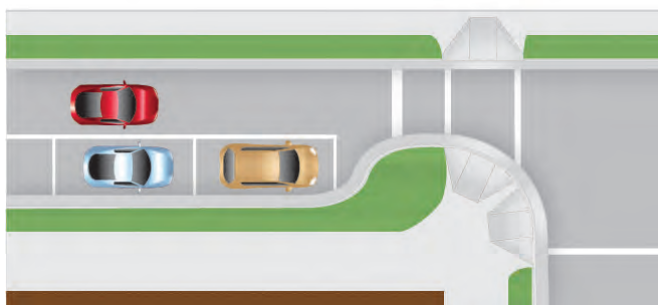
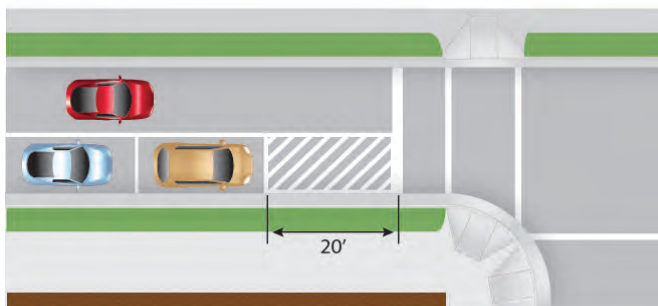
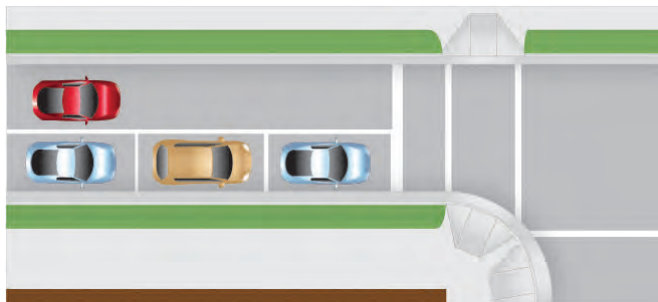

Curb extensions improve sight distance between pedestrians and motorists, possibly allowing additional on-street parking (Credit: Michele Weisbart)

toward the edge of the parking lane without entering the roadway, pedestrians can better see vehicles and motorists can better see pedestrians.

- Management of streetwater runoff

To fully achieve livability goals, the curb extension and parking area can be integrated into the furniture zone portion of the sidewalk corridor. This technique involves using similar surface materials for the curb extension, parking area, and the sidewalk as shown in the figure below. Instead of the curb extensions appearing to jut out into the street, the parking appears as “parking pockets” in the furniture zone.

To reinforce this design where street grades permit, the gutter line and drainage grates should be placed between the travel lane and the parking lane/curb extensions. This is called a “valley gutter” and creates a stronger visual cue separating the parking lane from the bicycle lane or travel lane. It can sometimes allow existing drainage infrastructure to be left in place.



Integrating curb extensions and on-street parking into the sidewalk corridor enhances pedestrian safety and the walking experience (Credit: Michele Weisbart)

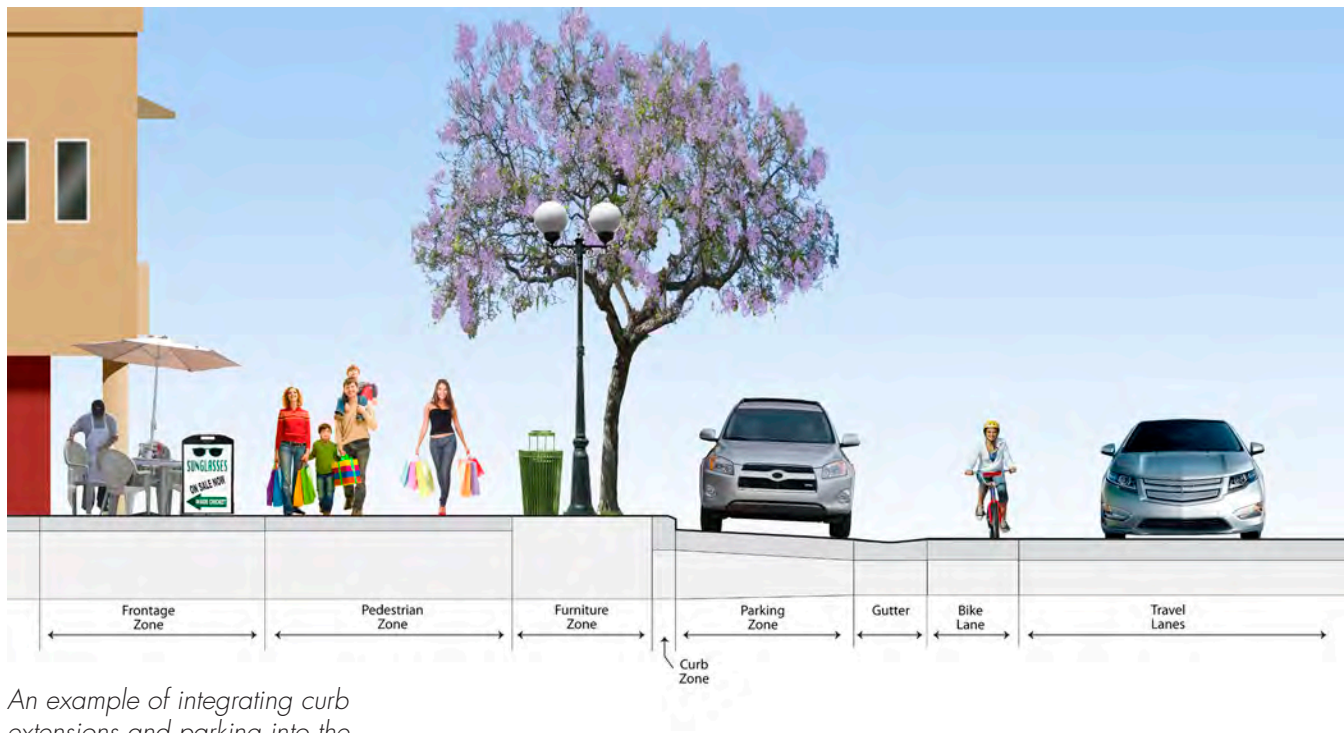

An example of integrating curb extensions and parking into the sidewalk corridor by placing a valley gutter between the parking and the traveled way
(Credit: Michele Weisbart)

Crosswalk and Ramp Placement

Crosswalks and ramps at intersections should be placed so they provide convenience and safety for pedestrians. The following recommended practices will help achieve these goals:

- Allow crossings on all legs of an intersection, unless there are no pedestrian accessible destinations on one or more of the corners. Closing a crosswalk usually results in a pedestrian either walking around several legs of the intersection, exposing them to more conflicts, or crossing at the closed location, with no clear path or signal indication as to when to cross.
- Provide marked crosswalks at signalized intersections.
- Place crosswalks as close as possible to the desire line of pedestrians, which is generally in line with the approaching sidewalks.
- Provide as short as possible a crossing distance to reduce the time that pedestrians are exposed to motor vehicles; this is usually as close as possible to right angles across the roadway, except for skewed intersections.

- Ensure that there are adequate sight lines between pedestrians and motorists. This typically means that the crosswalks should not be placed too far back from the intersection.
- When a raised median is present, extend the nose of the median past the crosswalk with a cut-through for pedestrians.
- Provide one ramp per crosswalk (two per corner for standard intersections with no closed crosswalks). Ramps must be entirely contained within a crosswalk (the crosswalk can be flared to capture a ramp that cannot be easily relocated). Align the ramp run with the crosswalk when possible, as ramps that are angled away from the crosswalk may lead some users into the intersection. At intersections where roads are skewed or where larger radii are necessary for trucks, it can be difficult to determine the best location for crosswalks and sidewalk ramps. In these situations, it is important to balance the recommended practices above. Tighter curb radii make implementing these recommendations easier, especially Recommendations 3, 4, and 5.



One curb ramp per crosswalk should be provided at corners. Ramps should align with sidewalks and crosswalks (Credit: Michele Weisbart)

On-Street Parking Near Intersections

On-street parking should be positioned far enough away from intersections to allow for good visibility of pedestrians preparing to cross the street. Curb extensions allow parking to be placed closer to the intersection.

Right-Turn Channelization Islands

Right-turn lanes should generally be avoided as they increase the size of the intersection, the pedestrian crossing distance, and the likelihood of right-turns-on-red by inattentive motorists who do not notice pedestrians on their right. However, where there are heavy volumes of right turns (approximately 200 vehicles per hour or more), a right-turn lane may be the best solution to provide additional vehicle capacity without adding additional lanes elsewhere in the intersection. For turns onto roads with only one through lane and where truck turning movements are rare, providing a small corner radius at the right-turn lane often provides the best solution for pedestrians' safety and comfort.

At intersections of multi-lane roadways where trucks make frequent right turns, a raised channelization island between the through lanes and the right-turn lane is a good alternative to an overly large corner radius and enhances pedestrian safety and access. If designed correctly, a raised island can achieve the following objectives:

- Allow pedestrians to cross fewer lanes at a time
- Allow motorists and pedestrians to judge the right turn/pedestrian conflict separately
- Reduce pedestrian crossing distance, which can improve signal timing for all users
- Balance vehicle capacity and truck turning needs with pedestrian safety
- Provide an opportunity for landscape and hardscape enhancement

The following design practices for right-turn lane channelization islands should be used to provide safety and convenience for pedestrians, bicyclists, and motorists:

- Provide a yield sign for the slip lane
- Provide at least a 60-degree angle between vehicle flows, which reduces turning speeds and improves the yielding driver's visibility of pedestrians and vehicles
- Place the crosswalk across the right-turn lane about one car length back from where drivers yield to traffic on the other street, allowing the yielding driver to respond to a potential pedestrian conflict first, independently of the vehicle conflict, and then move forward, with no more pedestrian conflict

These goals are best accomplished by creating an island that is roughly twice as long as it is wide. The corner radius will typically have a long radius (150 feet to 300 feet) followed by a short radius (20 feet to 50 feet). When creating this design, it is necessary to allow large trucks to turn into multiple receiving lanes. This design is often not practical for right-turn lanes onto roads with only one through lane. This right-turn channelization design is different from designs that provide free-flow movements (through a slip lane) where right-turning motorists turn into an exclusive receiving lane at high speed. Right turns should be signal-controlled in this situation to provide for a signalized pedestrian walk phase.



*Traffic channelization is an effective mitigation strategy when intersection radii reduction is not an option
(Credit: Michele Weisbart)*

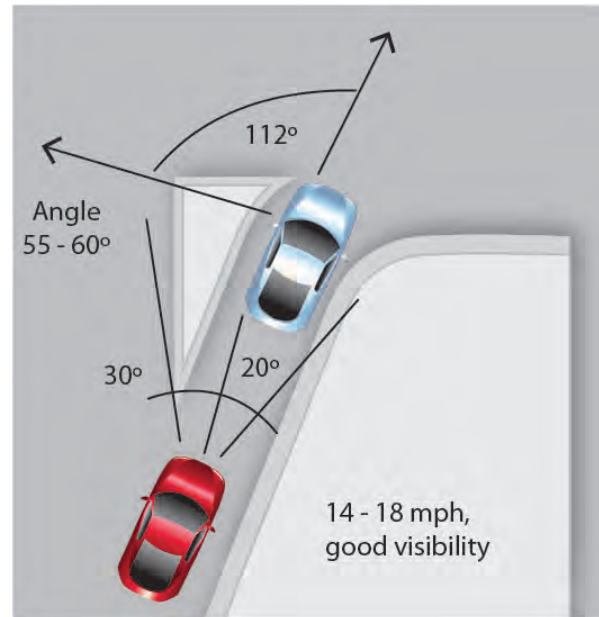
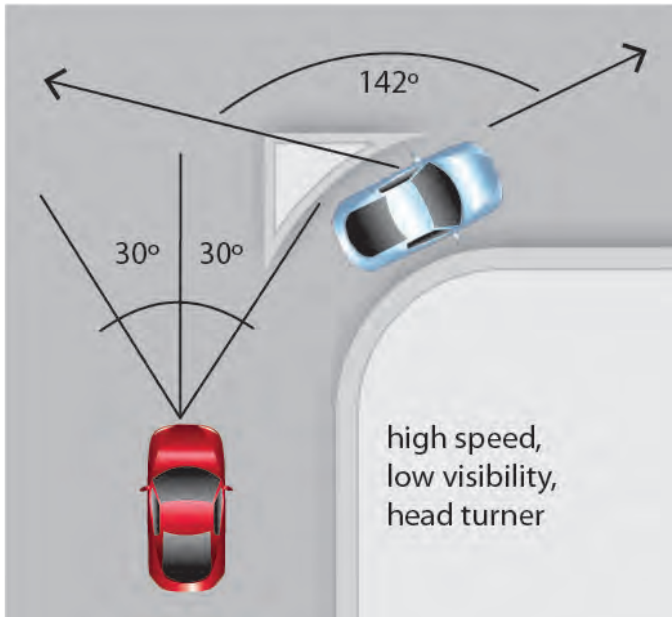

Sharper angles of slip lanes are important to slow cars and increase visibility (Credit: Michele Weisbart)

YIELD AND STOP CONTROLLED INTERSECTIONS

Intersection control options include the following:

- Yield control, which is under-utilized and should be considered to reduce unnecessary stops caused by the overuse of STOP signs.
- Uncontrolled intersections are yield controlled by default.
- Two-way stop control, the most common form of intersection control. This is also an overused device. At many intersections a neighborhood traffic calming circle is a preferable and more effective option.
- All-way stops are often overused, incorrectly, to slow traffic. The use of all-way stops should be consistent with the MUTCD. At many intersections a neighborhood traffic calming circle is a preferable and a more effective option.

SIGNALIZED INTERSECTIONS

Signalized intersections provide unique challenges and opportunities for livable communities and complete streets. On one hand, signals provide control of pedestrians and motor vehicles with numerous benefits. Where signalized intersections are closely spaced, signals can be used to control vehicle speeds by providing appropriate signal progression on a corridor. Traffic signals allow pedestrians and bicyclists to cross major streets with only minimal conflict with motor vehicle traffic. On the other hand, traffic signals create challenges for non-motorized users. Signalized intersections often have significant turning volumes, which conflict with concurrent pedestrian and bicycle movements. In many cases, roundabouts offer safer, more convenient intersection treatment than signals.

To improve livability and pedestrian safety, signalized intersections should

- Provide signal progression at speeds that support the target speed of a corridor whenever feasible
- Provide short signal cycle lengths, which allow frequent opportunities to cross major roadways, improving the usability and livability of the surrounding area for all modes
- Ensure that signals detect bicycles
- Place pedestrian signal heads in locations where they are visible
- At locations with many crossing pedestrians, time the pedestrian phase to be on automatic recall, so pedestrians don't have to seek and push a pushbutton.
- Where few pedestrians are expected and automatic recall of walk signals is not desirable, place pedestrian pushbuttons in convenient locations, using separate pedestals if necessary. Use the recommendations regarding pushbutton placement for accessible pedestrian signals found in the Manual on Uniform Traffic Control Devices (MUTCD).
- Include pedestrian signal phasing that increases safety and convenience for pedestrians, as discussed in more detail below



*Pole-mounted signal
(Credit: Ryan Snyder)*

Operational Design

Approximately 2 percent of intersections are signalized, and approximately 20 percent of all intersection crashes occur at signalized intersections. Unfortunately, in many locations signalization is the only option because of right-of-way limitations, high vehicle volumes, and the need to create gaps to provide reasonable operation for all users.

Over the years, the most common signal hardware has changed from post-mounted signals to overhead mast arms. This change has lifted drivers' eyes upward and created a situation in many east/west streets where drivers must look toward a rising or setting sun that can block vision of a signal. In urban areas the large mast arms are intrusive. As part of the conversion to healthier streets, changing to post-mounted signals in urban areas could lower the cost of installing and maintaining signals, reduce the vision intrusion, and help lower a driver's vision back to pedestrians. There are two advantages for pedestrians and bicyclists to pole-mounted signals:

- Drivers have to stop back from the crosswalk to see the indication so they are less likely to encroach into the crosswalk, and more likely to see pedestrians and bicyclists when turning right.
- Mast-arm signals encourage higher speeds since drivers can see several in a row. If they are green, drivers are more likely to accelerate. But pole-mounted signals are only visible to drivers closer to the intersection, causing them to drive slower on the approach.

Phasing

A signal phase is defined as the cycle length allocated to a traffic movement at an intersection receiving the right-of-way, or to any combination of traffic movements receiving the right of way simultaneously. The combination of all phases is equal to one cycle length.



Permissive left-turn signal



Protected-permissive left-turn signal



*Protected left-turn signal
(Credit: Michele Weisbart)*

Basic Signal Timing

The “timing” is the time in seconds allocated to various vehicular and pedestrian movements. A traffic control signal transmits information to the users by selective illumination of different color lights at a signalized intersection. The illuminated color indicates the user should take a specific action at the signalized intersection:

- **Green time.** Green time is when motorists and bicyclists may proceed through the intersection.
- **Yellow time.** Yellow time is the cycle phase before changing to the red interval that prohibits traffic movement. It signifies to users the light is about to turn red and they should stop if they can safely do so, or continue proceeding if that is safer. A properly timed yellow time interval is important to reduce signal violations by users passing through the intersection.
- **All-red time.** All-red time is that portion of a traffic cycle time where all vehicles are prohibited from any movements at the intersection. The all-red time follows the yellow time interval and precedes the next green interval. The purpose of the all-red time is to allow vehicles that entered the intersection late during the yellow time to clear the intersection before the traffic signal displays green time for conflicting approaches.

Left-Turn Phasing

The most commonly used “left turn” phases at an intersection with a left-turn lane are

- **Permissive.** Under permissive left turn phasing, through traffic may proceed straight through the intersection with a green ball, as side traffic is stopped (with a red ball); the left turning vehicles are permitted to make the turn when they find a safe and adequate gap from the approaching vehicles. Permissive left turn phases create conflicts with pedestrians crossing the street as the timing puts the two on a collision course.
- **Protected-permissive.** Under protected-permissive left turn phasing, left turns are allowed to pass the intersection with a green arrow first during the protected phase (opposing through traffic is stopped); usually three to five vehicles are allowed in the cycle before the left turn is changed from a left arrow to

a green ball, and opposing through traffic is allowed to pass through the intersection. During the permissive phase motorists may turn left while others go straight. Protected-permissive left turn phases create conflicts with pedestrians crossing the street as the timing puts the two on a collision course, especially with left-turning drivers who arrived after the left-turn phase and are impatient to turn left before the signal reverts to red.

- **Protected only.** Under protected left turns, drivers can only turn left with a left-turn green arrow. The protected left turns can be either “leading” or “lagging.” A leading protected left turn allows left-turns during the beginning of the cycle. A lagging protected left allows left turns at the end, after opposing through traffic has proceeded. Protected left-turn phases are preferred to both permissive phases because they eliminate the inherent conflict between left turning vehicles and pedestrians. Protected left turns provide the greatest safety for pedestrians. Permissive phases are typically used to maintain a higher LOS for motorists.

Pedestrian Phasing

Basic pedestrian signal timing principles should be combined with innovative pedestrian signal timing techniques to enhance pedestrian safety and convenience.

Pedestrian signal heads provide indications exclusively intended for controlling pedestrian traffic. These signal indications consist of the illuminated symbols of a WALKING PERSON (symbolizing WALK) and an UPRAISED HAND (symbolizing DON'T WALK). Pedestrian signal head indications have the following meanings:

- A steady WALKING PERSON (WALK) signal indication means that a pedestrian facing the signal indication is permitted to start to cross the roadway in the direction of the signal indication, possibly in conflict with turning vehicles.
- A flashing UPRAISED HAND (DON'T WALK) signal indication means that a pedestrian shall not start to cross the roadway in the direction of the signal indication, but that any pedestrian who has already started to cross shall proceed to the far side of the traveled way of the street or highway, unless otherwise

directed by a traffic control device to proceed only to a median or pedestrian refuge area.

- A steady UPRAISED HAND (DON'T WALK) signal indication means that a pedestrian shall not enter the roadway in the direction of the signal indication.

The text below discusses the timing of each of these indicators.



Walk signal (Credit: Sky Yim)

Walk Interval

The WALK interval (white walking person) must typically be a minimum of 7 seconds. However, to provide more convenience for pedestrians, and possibly more safety due to better pedestrian behavior, the WALK interval should be maximized using the following techniques:

- Instead of providing the minimum WALK interval, maximize the WALK interval within the available green interval. This is accomplished by subtracting the necessary pedestrian clearance interval (discussed below) from the available green time for the concurrent vehicular movements.
- Except at intersections where pedestrians are relatively few, and anywhere that vehicle signals are set on fixed time, WALK intervals should be set on “recall” so that they are automatically provided during every signal cycle.
- Where a major street intersects a minor side street, the WALK interval for crossing the minor street can be set on recall, concurrent with the green interval for the parallel through vehicle movement, which is typically set to recall as well. This minimizes pedestrian delay along the major street with no impact to motor vehicle capacity.



Pedestrian countdown signals (Credit: Sky Yim)

Pedestrian Clearance Interval

The procedures for calculating the timing of the pedestrian clearance interval (flashing orange hand) are included in the MUTCD, but have recently changed. The pedestrian clearance interval is calculated to allow a pedestrian traveling at a walking speed of 3.5 feet per second to travel the length of the crosswalk. The crosswalk length should be measured from the center of one curb ramp to the center of the

opposing curb ramp. This speed allows pedestrians, especially seniors, children, and disabled people, to clear the intersection. The MUTCD includes another test that requires the total of the WALK interval plus the pedestrian clearance interval to be sufficient to allow a pedestrian traveling at a walking speed of 3 feet per second to travel the length of the crosswalk, measured from the top of one ramp to the bottom of the opposing ramp. Any additional time that is required to satisfy this second requirement should be added to the walk interval. In neighborhoods where high numbers of slow pedestrians are present, such as near senior centers, rehabilitation centers, and disabled centers, the interval should be set for even slower speeds.

The MUTCD also requires that countdown pedestrian signals be installed for all pedestrian signals. These signals count down the pedestrian clearance interval and provide more information to pedestrians, allowing them to more easily adjust their walking patterns to ensure they are out of the crosswalk before the end of the pedestrian clearance interval. Research on pedestrian countdown signals has determined

- Pedestrians understand how they work.
- Fewer people start walking in the pedestrian clearance interval.
- Very few pedestrians are left in the crosswalk during the steady orange hand.
- Drivers don't accelerate to beat the light.
- Research in San Francisco shows a 25 percent reduction in all crashes.

Other Signal Design Changes for Pedestrians

Where appropriate, use signal timing and operations techniques that minimize conflicts with pedestrians and motor vehicles, including the following:

- Protected only left-turn phases
- Leading pedestrian intervals (LPI) where the pedestrian WALK interval is displayed 2 to 5 seconds prior to the concurrent green interval. This enables pedestrians to enter the crosswalk before drivers turn, increasing their chances of being seen by drivers.

- Prohibiting right-turns-on-red where there are restricted sight lines between motorists and pedestrians, where there are an unusual number of pedestrian conflicts with turns on red compared to right-turns-on-green, or where a leading pedestrian interval is used
- Signs that remind drivers to yield to pedestrians when turning at signals
- Pedestrian-user-friendly-intelligent (PUFFIN) signals, which detect slower pedestrians in crosswalks and add clearance interval time to the pedestrian signal
- Pedestrian scrambles, which stop traffic on all legs of the intersection and allow pedestrians to cross diagonally, may be used where turning vehicles conflict with very high pedestrian volumes. Although pedestrians can cross in any direction during the pedestrian phase, pedestrians typically have to wait for both vehicle phases before they get the walk signal again. Scramble intersections can incorporate a walk phase concurrent with the green phase for pedestrians continuing along a straight path to eliminate this delay.

ROUNDBABOUTS

Modern roundabouts are potentially the cheapest, safest, and most aesthetic form of traffic control for many intersections. A roundabout is an intersection design with the following characteristics and features.

Users approach the intersection, slow down, stop and/or yield to pedestrians in a crosswalk, and then enter a circulating roadway, yielding to drivers already in the roundabout. The circulating roadway encircles a central island around which vehicles travel counterclockwise. Splitter islands force drivers to turn right, and provide a refuge for pedestrians. Deflection encourages slow traffic speeds, but allows movement by trucks. A landscaped visual obstruction in the central island obscures the driver's view of the road ahead, to discourage users from entering the roundabout at high speeds. Pedestrians are not allowed to access the central island, which should not contain attractions. The central island can vary in shape from a circle to a "square-a-bout" in historic areas, ellipses at odd shaped intersections, dumbbell, or even peanut shapes.



*Roundabout: San Diego, CA
(Credit: Michael Wallwork)*

Each leg of a roundabout has a triangular splitter island that provides a refuge for pedestrians, prevents drivers from turning left (the “wrong-way”), guides drivers through the roundabout by directing them to the edge of the central island, and helps to slow drivers. Roundabouts can range from quite small to quite large, from a central island diameter of about 12 feet for a traffic calming device at a neighborhood intersection to 294 feet to the back of sidewalk on a large multi-lane roundabout.

This section of the chapter briefly describes roundabout application and design information. For more detailed information, refer to NCHRP Report 672, *Roundabouts: An Informational Guide*, Second Edition.

Advantages and Disadvantages

Roundabouts reduce vehicle-to-vehicle and vehicle-to-pedestrian conflicts and, thanks to a substantial reduction in vehicle speeds, reduce all forms of crashes and crash severity. In particular, roundabouts eliminate the most dangerous and common crashes at signalized intersections: left-turn and right-angle crashes.

Other benefits of roundabouts include the following:

- Little to no delay for pedestrians, who have to cross only one direction of traffic at a time
- Improved accessibility to intersections for bicyclists through reduced conflicts and vehicle speeds
- A smaller carbon footprint (no electricity is required for operation and fuel consumption is reduced as motor vehicles spend less time idling and don't have to accelerate as often from a dead stop)
- The opportunity to reduce the number of vehicle lanes between intersections (e.g., to reduce a five-lane road to a two-lane road, due to increased vehicle capacity at intersections)
- Little to no stopping during periods of low flow
- Significantly reduced maintenance and operational costs because the only costs are related to the landscape and litter control
- Reduced delay, travel time, and vehicle queue lengths
- Lowered noise levels
- Less fuel consumption and air pollution
- Simplified intersections
- Facilitated U-turns
- The ability to create a gateway and/or a transition between distinct areas through landscaping
- When constructed as a part of a new road or the reconstruction of an existing road, the cost of a roundabout is minimal and can be cheaper than the construction of an intersection and the associated installation of traffic signals and additional turn lanes
- Light rail can pass through the center of a roundabout without delay because rail has the right of way

The primary disadvantage is that sight-impaired people can have difficulty navigating around large roundabouts. But this can be mitigated with ground level wayfinding devices.

General Design Elements of Roundabouts

Central Island

The design of the central island is an important element of a roundabout. In conjunction with well-designed approach and departure lanes, the central island controls vehicle speeds through deflection and controls the size of vehicles that can pass through and turn at a roundabout. It provides space for landscaping to beautify an intersection or create a focal point or community enhancement, but it also provides space for the inclusion of a vertical element such as a tree, which is important in providing long range conspicuity of a roundabout.

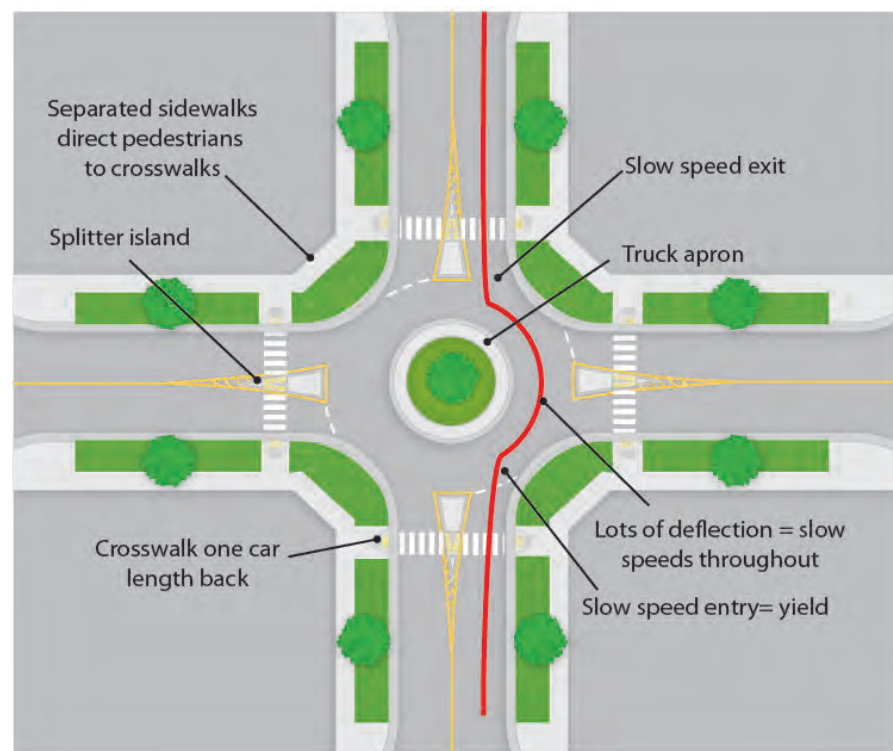

*Single-lane roundabout
(Credit: Michele Weisbart)*

Splitter Islands

Splitter islands and/or medians on each approach serve several functions. Most importantly, they provide a refuge for pedestrians crossing at the roundabout, breaking the crossing into two smaller crossings. This allows pedestrians to select smaller gaps and cross more quickly. Splitter islands and medians direct vehicles toward the edge of the central island and limit the ability of drivers to make left turns the wrong way into the circulating roadway. Splitter islands should have a minimum width of 6 feet, and preferably 8 feet, from the face-of-curb to the opposite face-of-curb.

Truck Apron

Because central islands must be made large enough to deflect and hence control the speed of passenger vehicles, they can limit the ability of trucks to pass through or turn at a roundabout. To accommodate large vehicles, a truck apron (a paved, load-bearing area) is included around the edge of the central island. The truck apron is often paved with a fairly rough texture, and raised enough to discourage encroachment by smaller high-speed passenger cars. The truck apron should be 3 inches high.

Pedestrian Crossings

Pedestrian crossings are located one car length away from the circulating roadway to shorten the crossing distance, separate vehicle-to-pedestrian conflicts from vehicle-to-vehicle conflicts, and allow pedestrians to cross between waiting vehicles.

Signing and Marking

Signing and marking should be in compliance with the current version of the MUTCD. For detailed design guidance on roundabouts, refer to the NCHRP Report 672, *Roundabouts: An Informational Guide*, Second Edition, 2010. However, care must be taken to not oversign roundabouts by including every sign allowed at roundabouts, except for needed directional signs; most roundabouts are designed so their function and use are self-explanatory.

Roundabout Design Criteria

Before starting the design of a roundabout it is very important to determine the following:

- The number and type of lane(s) on each approach and departure as determined by a capacity analysis
- The design vehicle for each movement
- The presence of on-street bike lanes
- The goal/reason for the roundabout, such as crash reduction,

capacity improvement, speed control, or creation of a gateway or a focal point

- Right-of-way and its availability for acquisition if needed
- The existence or lack of sidewalks
- The approach grade of each approach
- Transit, existing or proposed

Operations and Analysis

Roundabouts operate on the principle that drivers approach a roundabout and look left for any approaching vehicles that could conflict with their travel path. If there is no possible conflict, the approaching driver can enter the roundabout without delay. If there is a vehicle, or many conflicting vehicles, the approaching drivers stop and yield to the conflicting vehicle(s) on their left and wait for a safe gap to enter the roundabout.

In simple terms, a roundabout capacity analysis determines the number of vehicles seeking to enter a roundabout from each approach and the availability of gaps. Based on this gap acceptance analysis, the number and type of approach and departure lanes can be determined to provide the desired level of operation. Since roundabouts keep traffic moving they have greater capacity than both signalized and stop-controlled intersections. Roundabout designer Michael Wallwork has observed about a 30 percent increase in intersection capacity with roundabouts over traffic signals.

Single-Lane Roundabouts

Single-lane roundabouts can vary in size with central island diameters from 12 to 90 feet to fit a wide range of intersections and accommodate through movements and different turn movements by various design vehicles. As such, they can be used at a large number of intersections to achieve various objectives.

In some cases, roundabouts are constructed to accommodate through movements by large articulated trucks but do not permit them to make turn movements. However, they do accommodate turn movements by single unit trucks such as ladder trucks and garbage trucks. In some

cases, restricting or not accommodating turn movements by articulated trucks enables the construction of a smaller roundabout without acquisition of right-of-way and with all the benefits of roundabouts at the cost of forcing the occasional large truck to take an alternate route.

Design

Following a careful assessment of the need to accommodate some or all design vehicle movements and the impact of that accommodation, the size of the roundabout is selected and a concept plan is prepared. The concept plan is then refined with the simultaneous application of design vehicle templates and design speed checks until a suitable design is prepared that meets design requirements. Pedestrian and bike facilities are as applicable and the overall design is refined with the signing and marking, along with construction details. In some cases, right turn lanes can be added to accommodate specific high right turn volumes.

Multi-Lane Roundabouts

When single-lane roundabouts prove to be inadequate for the traffic volume, consideration should be given to using roundabouts that have two through lanes on the major street and a single lane on the minor street with or without additional turn lanes before automatically designing a full multilane roundabout. Because these roundabouts are larger than single-lane roundabouts, they often accommodate all turn movements by most large vehicles. However, it is still necessary to confirm the size and movements by the design vehicle(s) because these roundabouts often have to accommodate larger trucks or special vehicles.

With many old style freeway interchanges failing, often because of a lack of storage for turning vehicles, retrofitting a roundabout on both sides of the freeway can reduce congestion and improve pedestrian mobility without widening the freeway bridge. Sometimes, the retrofit of a standard interchange with roundabouts can reduce the space allocated to the interchange, freeing the land for other community uses.

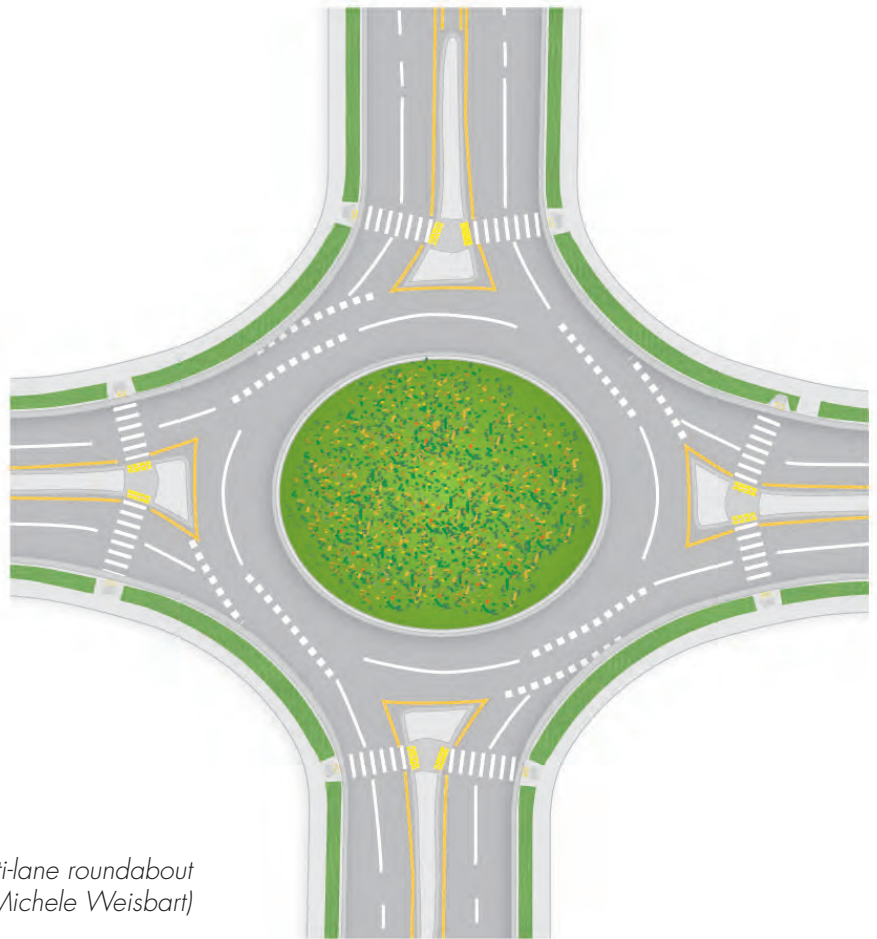

*Multi-lane roundabout
(Credit: Michele Weisbart)*

Accessibility

Multi-lane roundabouts are more complex for pedestrians and bicyclists to use because of the additional lanes, slightly higher speeds, and longer crossing distances. Crossing by some pedestrians with disabilities is a more complex task. As a consequence, the current draft (Proposed Right-of-Way Accessibility Guidelines) PROWAG includes a requirement to install accessible pedestrian signals at all crosswalks across any roundabout approach with two or more lanes in one direction. The PROWAG requirement does not specify the type of signal except that it must be accessible, including a locator tone at the pushbutton, with audible and vibrotactile indications of the pedestrian walk interval.

Metering signals

Often a roundabout capacity is only exceeded during one peak period and often for only a short period. Rather than constructing a larger

multi-lane roundabout, consideration should be given to constructing a smaller roundabout that is adequate for 23 hours a day and adding a metering signal for the short peak period when congestion can occur. A metering signal is similar to ramp metering where the approaching vehicle queue is metered and a part time signal is used to stop the conflicting vehicle flow to allow the congested approach to enter the roundabout. The result is a smaller, slower roundabout that is more appropriate for all users for most of the day.

Design

Multi-lane roundabouts are more complex to design. However, the design process is the same as for single-lane roundabouts: confirm the design vehicle for each movement, prepare a concept plan, and refine it with the simultaneous use of design vehicle templates or software like AutoTURN and speed curves.

Mini-Roundabouts

Mini-roundabouts are a new form of roundabout that includes a traversable central island and traversable splitter islands to accommodate large vehicles.

Appropriate Applications

Mini-roundabouts are used in low-speed urban environments, where operating speeds are 30 mph or less, and right-of-way constraints preclude the use of a standard roundabout. The design is based on passenger vehicles passing through the roundabout without travelling over the central island, whereas large vehicles will turn over the central island and in some cases, the splitter islands.

Design

The design of mini-roundabouts is similar to other roundabouts in that the design vehicle for each movement must be determined following a capacity analysis. The design is undertaken using the same combination of design vehicle templates and speed curves.

Neighborhood Traffic Circles

Neighborhood traffic circles are very small circles that are retrofitted into local street intersections to control vehicle speeds within a neighborhood. Typically, a tree and/or landscaping are located within the central island to provide increased visibility of the roundabout and enhance the intersection. Neighborhood traffic circles should generally have similar features as roundabouts, including yield-on-entry and painted or mountable splitter islands.

Neighborhood traffic circles should be used on low-volume, neighborhood streets. In these environments, larger vehicles can turn left in front of the central island.

Design

The design of neighborhood traffic circles is primarily confined to selecting a central island size to achieve the appropriate design speed of around 15 to 18 mph. See Chapter 10, "Traffic Calming," for more information.



*Neighborhood traffic circle
(Credit: Ryan Snyder)*

Chapter 6. UNIVERSAL PEDESTRIAN ACCESS

INTRODUCTION.....	6-2
ESSENTIAL PRINCIPLES OF UNIVERSAL PEDESTRIAN ACCESS.....	6-3
LEGAL FRAMEWORK.....	6-3
USERS AND NEEDS.....	6-5
People with Mobility Impairments.....	6-5
People with Visual Impairments.....	6-6
People with Cognitive Impairments.....	6-7
Children and Older Adults.....	6-7
PEDESTRIAN FACILITY DESIGN.....	6-8
Sidewalks.....	6-8
Curb Ramps.....	6-11
Detectable Warnings.....	6-16
Signals.....	6-17
LAND USE AND SIDEWALK DESIGN GUIDELINES.....	6-19
Low / Medium Density Residential.....	6-20
Medium / High Density Residential.....	6-20
Neighborhood Commercial.....	6-21
General / Regional Commercial.....	6-21
Mixed / Multi-Use.....	6-22
Industrial.....	6-22
Downtown Core/Main Street.....	6-23
Office Park.....	6-23
Public Facilities.....	6-24
DESIGN SPECIFICATIONS BY ROADWAY TYPE AND LAND USE.....	6-24
General Guidelines.....	6-27
FOR MORE INFORMATION.....	6-27



INTRODUCTION

Nowhere is the concept of universal access more important than in the design of the pedestrian environment. While perhaps not intuitively obvious at first glance, this is the realm of streets with the greatest variation in user capabilities, and thus the realm where attention to design detail is essential to effectively balance user needs. This is also the realm where signs and street furniture are located, and where transitions are made between modes (e.g., driver or passenger to pedestrian via parking, bus stop/train station, or bike rack). The pedestrian environment includes sidewalks, curb ramps, crosswalks, bus stops, signs, and street furniture.

Without design guidelines, sidewalks are often too narrow, utility poles obstruct travel, steep driveway ramps are impassable to wheelchair users, and bus stops become blocked by the disorderly placement of shelters, poles, trash receptacles, and bike racks.

With well-defined guidelines, sidewalks are built to accommodate pedestrians of all ages and physical abilities, and become inviting pedestrian environments as the adjacent picture shows.

Designing the pedestrian realm for universal access enables persons with disabilities to live independently and lead full, enriched lives; they are able to go to work and to school, to shop, and otherwise engage in normal activities. Moreover, walking environments that accommodate people with disabilities improve walking conditions for everyone. People with strollers and rolling suitcases can make their way about

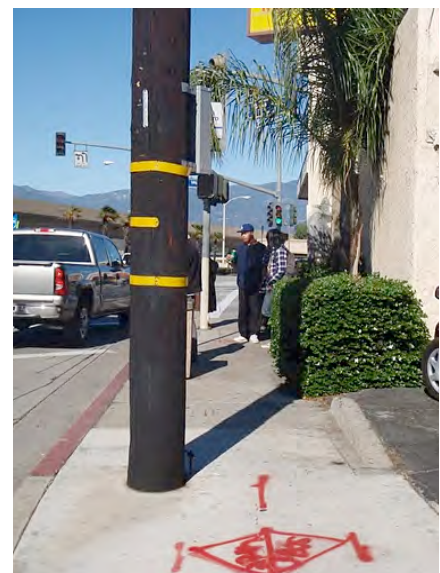
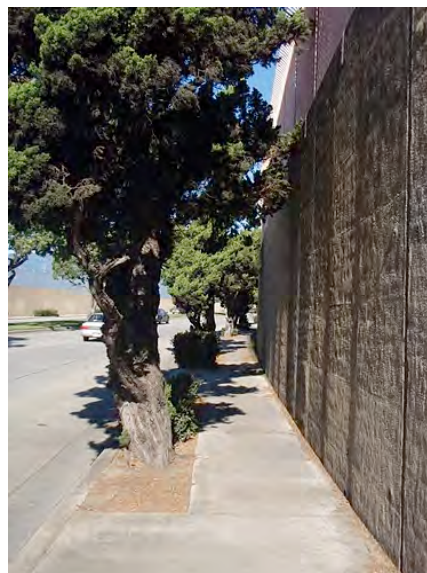

Sidewalks constructed without adequate design guidelines (Credit: Chanda Singh)

with ease. Children can mature by learning to navigate through their neighborhoods with independence. Inaccessible pedestrian networks, on the other hand, can lead to people becoming housebound and socially isolated, which in turn can lead to a decline in well-being and a host of associated negative health outcomes such as depression.

This chapter describes the legal framework for accessible design of streets and sidewalks, various users of streets and sidewalks and their needs, and important elements of pedestrian facility design. The chapter ends with sidewalk design guidelines for a number of street classifications.

ESSENTIAL PRINCIPLES OF UNIVERSAL PEDESTRIAN ACCESS

The following design principles inform the recommendations made in this chapter and should be incorporated into every pedestrian improvement:

- The walking environment should be safe, inviting, and accessible to people of all ages and physical abilities.
- The walking environment should be easy to use and understand.
- The walking environment should seamlessly connect people to places. It should be continuous, with complete sidewalks, well-designed curb ramps, and well-designed street crossings

LEGAL FRAMEWORK



Wheelchair users need accessible sidewalks (Credit: Dan Burden)

Under Title II of the Americans with Disabilities Act (ADA) of 1990, state and local governments and public transit authorities must ensure that all of their programs, services, and activities are accessible to and usable by individuals with disabilities. They must ensure that new construction and altered facilities are designed and constructed to be accessible to persons with disabilities. State and local governments must also keep the accessible features of facilities in operable working condition through maintenance measures including sidewalk repair, landscape trimming, work zone accessibility, and snow removal.

Under the ADA, the U.S. Access Board is responsible for developing the minimum accessibility guidelines needed to measure compliance with ADA obligations when new construction and alterations projects are planned and engineered. These guidelines for public rights-of-way are found in draft form in the Public Rights-of-Way Accessibility Guidelines (draft PROWAG). The U.S. Department of Transportation

has recognized this document as current best practices in pedestrian design and has indicated its intent to adopt the final PROWAG.

In addition to the PROWAG guidelines, Title II of the ADA also requires states and localities to develop ADA Transition Plans that remove barriers to disabled travel.

These plans must

- Inventory physical obstacles and their location
- Provide adequate opportunity for residents with disabilities to provide input into the Transition Plan
- Describe in detail the methods the entity will use to make the facilities accessible
- Provide a yearly schedule for making modifications
- Name an official/position responsible for implementing the Transition Plan
- Set aside a budget to implement the Transition Plan

ADA Transition Plans are intended to ensure that existing inaccessible facilities are not neglected indefinitely and that the community has a detailed plan in place to provide a continuous pedestrian environment for all residents.



Obstructions can make passage difficult or impossible for wheelchair users (Credit: Michael Ronkin)

USERS AND NEEDS

To fully accommodate everybody, designers must consider the widely varying needs and capabilities of the people in the community. People walk at different speeds. Some are able to endure long treks, while others can only go short distances. Some use wheelchairs and are particularly sensitive to uneven pavement and surface materials. Others have limited sight and rely on a cane. People's strengths, sizes, and judgmental capabilities differ significantly. The needs of one group of users may be at odds with those of another group of users. For instance, gradual ramps and smooth transitions to the street help people in wheelchairs, but present challenges for the sight-impaired when they can't easily find the end of the sidewalk and beginning of the street.

The text below identifies the unique constraints individuals with different types of disabilities and limitations face as pedestrians. Understanding their needs will help ensure more universal design of the sidewalk network.

People with Mobility Impairments

People with mobility impairments range from those who use assistive devices, such as wheelchairs, crutches, canes, orthotics, and prosthetic devices, to those who use no such devices but face constraints walking long distances on non-level surfaces or on steep grades.

Wheelchair and scooter users are most affected by the following:



*Steep cross slopes create difficulties for wheelchair users
(Credit: Michael Ronkin)*

- Uneven surfaces that hinder movement
- Rough surfaces that make rolling difficult and can cause pain, especially for people with back injuries
- Steep uphill slopes that slow the user
- Steep downhill slopes that cause a loss of control
- Cross slopes that make the assistive device unstable
- Narrow sidewalks that impede the ability of users to turn or to cross paths with others
- Devices that are hard to reach, such as push buttons for walk signals and doors
- The lack of time to cross the street



Walking-aid users need clear sidewalks (Credit: Dan Burden)

Walking-aid users are most affected by the following:

- Steep uphill slopes that make movement slow or impossible
- Steep downhill slopes that are difficult to negotiate
- Cross slopes that cause the walker to lose stability
- Uneven surfaces that cause these users to trip or lose balance
- Long distances
- Situations that require fast reaction time
- The lack of time to cross the street

Prosthesis users often move slowly and have difficulty with steep grades or cross slopes.



Sight-impaired pedestrians need additional sensory cues (Credit: Dan Burden)

People with Visual Impairments

People with visual impairments include those who are partially or fully blind, as well as those who are colorblind. Visually impaired people face the following difficulties:

- Limited or no visual perception of the path ahead
- Limited or no visual information about their surroundings, especially in a new place
- Changing environments where they rely on memory
- Lack of non-visual information
- Inability to react quickly
- Unpredictable situations, such as complex intersections that are not at 90 degrees
- Inability to distinguish the edge of the sidewalk from the street
- Compromised ability to detect the proper time to cross a street
- Compromised ability to cross a street along the correct path
- Need for more time to cross the street

People with Cognitive Impairments

People with cognitive impairments encounter difficulties in thinking, learning, and responding, and in performing coordinated motor skills. Cognitive disabilities can cause some to become lost or have difficulty finding their way. They may also not understand standard street signs and traffic signals. Some may not be able to read and benefit from signs with symbols and colors.

Children and Older Adults

Children and many older adults don't fall under specific categories for disabilities, but must be taken into account in pedestrian planning. Children are less mentally and physically developed than adults and have the following characteristics:

- Less peripheral vision
- Limited ability to judge speed and distance
- Difficulty locating sounds
- Limited or no reading ability so don't understand text signs
- Occasional impulsive or unpredictable behavior
- Little familiarity with traffic
- Difficulty in carrying packages

Small children are also more difficult to see than adults.

The natural aging process generally results in at least some decline in sensory and physical capability. As a result, many older adults experience the following:

- Declining vision, especially at night
- Decreased ability to hear sounds and detect where they come from
- Less strength to walk up hills and less endurance overall
- Reduced balance, especially on uneven or sloped sidewalks

- Slowed reaction times to dangerous situations
- Slowed walking speed
- Increased fragility and frailty: their bodies are more likely to be seriously injured in a fall or vehicular crash and their recovery becomes longer and more tenuous. This makes older pedestrians the most vulnerable pedestrians.

To provide a seamless path of travel throughout the community that is accessible to all, designers should consider five important elements: sidewalks, curb ramps, crosswalks, signals, and bus stops.

PEDESTRIAN FACILITY DESIGN

Sidewalks

Sidewalks should provide a comfortable space for pedestrians between the roadway and adjacent land uses. Sidewalks along city streets are the most important component of pedestrian mobility. They provide access to destinations and critical connections between modes of travel, including automobiles, transit, and bicycles. General provisions for sidewalks include pathway width, slope, space for street furniture, utilities, trees and landscaping, and building ingress/egress.

Sidewalks include four distinct zones: the frontage zone, the pedestrian (aka walking) zone, the furniture zone, and the curb zone. The minimum widths of each of these zones vary based on street classifications as well as land uses. The Street Classifications section in this chapter describes these recommendations in more detail as applied to individual cities. The table at the end of this chapter recommends minimum widths for each zone for different street types and land uses.

Frontage Zone

The frontage zone is the portion of the sidewalk located immediately adjacent to buildings, and provides shy distance from buildings, walls, fences, or property lines. It includes space for building-related features such as entryways and accessible ramps. It can include landscaping as well as awnings, signs, news racks, benches, and outdoor café seating. In single family residential neighborhoods, landscaping typically occupies the frontage zone.

Pedestrian Zone

The pedestrian zone, situated between the frontage zone and the furniture zone, is the area dedicated to walking and should be kept clear of all fixtures and obstructions. Within the pedestrian zone, the Pedestrian Access Route (PAR) is the path that provides continuous connections from the public right-of-way to building and property entry points, parking areas, and public transportation. This pathway is required to comply with ADA guidelines and is intended to be a seamless pathway for wheelchair and white cane users. As such, this route should be firm, stable, and slip-resistant, and should comply with maximum cross slope requirements (2 percent grade). The walkway grade shall not exceed the general grade of the adjacent street. Aesthetic textured pavement materials (e.g., brick and pavers) are best used in the frontage and furniture zones, rather than the PAR. The PAR should be a minimum of 4 feet, but preferably at least 5 feet in width to provide adequate space for two pedestrians to comfortably pass or walk side by side. All transitions (e.g., from street to ramp or ramp to landing) must be flush and free of changes in level. The engineer should determine the pedestrian zone width to accommodate the projected volume of users. In no case will this zone be less than the width of the PAR.

Non-compliant driveways often present significant obstacles to wheelchair users. The cross slope on these driveways is often much steeper than the 2 percent maximum grade. Driveway aprons that extend into the pedestrian zone can render a sidewalk impassable to users of wheelchairs, walkers, and crutches. They need a flat plane on which to rest all four supports (two in the case of crutches). To provide a continuous PAR across driveways, aprons should be confined to the furniture and curb zones.



Routing sidewalks around driveway ramps maintains a flush surface (Credit: Dan Burden)

Furniture Zone

The furniture zone is located between the curb line and the pedestrian zone. The furniture zone should contain all fixtures, such as street trees, bus stops and shelters, parking meters, utility poles and boxes, lamp posts, signs, bike racks, news racks, benches, waste receptacles, drinking fountains, and other street furniture to keep the pedestrian zone free of obstructions. In residential neighborhoods, the furniture zone is often landscaped. Resting areas with benches and space for wheelchairs should be provided in high volume pedestrian districts and along blocks with a steep grade to provide a place to rest for older adults, wheelchair users, and others who need to catch their breath.

Curb Zone

The curb zone serves primarily to prevent water and cars from encroaching on the sidewalk. It defines where the area for pedestrians begins, and the area for cars ends. It is the area people using assistive devices must traverse to get from the street to the sidewalk, so its design is critical to accessibility.

Other Sidewalk Guidelines

- Landscaped buffers or fences should separate sidewalks from off-street parking lots or off-street passenger loading areas.
- Pedestrian and driver sight distances should be maintained near driveways. Fencing and foliage near the intersection of sidewalks and driveways should ensure adequate sight distance as vehicles enter or exit.
- Where no frontage zone exists, driveway ramps usually violate cross slope requirements. In these situations, sidewalks should be built back from the curb at the driveway as shown in the adjacent photo.

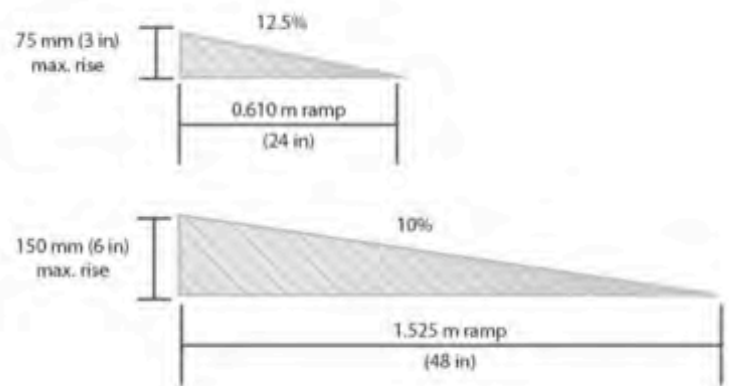

*Curb ramp components, and alternate ramp slopes
(Credit: Michele Weisbart)*

Curb Ramps

Proper curb ramp design is essential to enable pedestrians using assistive mobility devices (e.g., scooters, walkers, and crutches) to transition between the street and the sidewalk. These design guidelines provide a basic overview of curb ramp design. The ADA requires installation of curb ramps in new sidewalks and whenever an alteration is made to an existing sidewalk or street. Roadway resurfacing is considered an alteration and triggers the requirement for curb ramp installations or retrofits to current standards. Curb ramps are typically installed at intersections, mid-block crossings (including trail connections), accessible on-street parking, and passenger loading zones and bus stops.

The following define the curb ramp components along with minimum dimensions:

- Landing – the level area at the top of a curb ramp facing the ramp path. Landings allow wheelchairs to enter and exit a curb ramp, as well as travel along the sidewalk without tipping or tilting. This landing must be the width of the ramp and measure at least 4 feet by 4 feet. There should also be a level (not exceeding a 2 percent grade) 4 foot by 4 foot bottom landing of clear space outside of vehicle travel lanes.
- Approach – the portion of the sidewalk on either side of the landing. Approaches provide space for wheelchairs to prepare to enter landings.
- Flare – the transition between the curb and sidewalk. Flares provide a sloped transition (10 percent maximum slope) between the sidewalk and curb ramp to help prevent pedestrians from tripping over an abrupt change in level. Flares can be replaced with curb where the furniture zone is landscaped.
- Ramp – the sloped transition between the sidewalk and street where the grade is constant and cross slope at a minimum. Curb ramps are the main pathway between the sidewalk and street.
- Gutter – the trough that runs between the curb or curb ramp and the street. The slope parallel to the curb should not exceed 2 percent at the curb ramp.
- Detectable Warning – surface with distinct raised areas to alert pedestrians with visual impairments of the sidewalk-to-street transition.



Parallel curb ramp
(Credit: Michele Weisbart)

There are several different types of curb ramps. Selection should be based on local conditions. The most common types are diagonal, perpendicular, parallel, and blended transition. PROWAG provides additional design guidance and curb ramp examples appropriate for a variety of contextual constraints.



Diagonal Curb Ramps

Diagonal curb ramps are single curb ramps at the apex of the corner. These have been commonly installed by many jurisdictions to address the requirements of the ADA, but have since been identified as a non-preferred design type as they introduce dangers to wheelchair users. Diagonal curb ramps send wheelchair users and people with strollers or carts toward the middle of the intersection and make the trip across longer.

Perpendicular Curb Ramps

Perpendicular curb ramps are placed at a 90-degree angle to the curb. They must include a level landing at the top to allow wheelchair users to turn 90 degrees to access the ramp, or to bypass the ramp if they are proceeding straight. Perpendicular ramps work best where there is a wide sidewalk, curb extension, or planter strip. Perpendicular curb ramps provide a direct, short trip across the intersection.



*One ramp per crosswalk vs. single ramp at the apex
(Credit: Michele Weisbart)*

Parallel Curb Ramps

Parallel curb ramps are oriented parallel to the street; the sidewalk itself ramps down. They are used on narrow sidewalks where there isn't enough room to install perpendicular ramps. Parallel curb ramps require pedestrians who are continuing along the sidewalk to ramp down and up. Where space exists in a planting strip, parallel curb ramps can be designed in combination with perpendicular ramps to reduce the ramping for through pedestrians. Careful attention must be paid to the construction of the bottom landing to limit accumulation of water and/or debris.

Curb Ramp Placement

For best practices in ramp placement, refer to Chapter 5, "Intersection Design."

One ramp should be provided for each crosswalk, which usually translates to 2 per corner. This maximizes access by placing ramps in line with the sidewalk and crosswalk, and by reducing the distance required to cross the street, compared with a single ramp on the apex.

Table 6.1 Curb Ramp Design Standards and Guidelines

Curb Ramp Type	Characteristic	ADA Standards	PROWAG
Perpendicular	Maximum slope of ramps	8.33%	8.3%
	Maximum cross-slope of ramps	2%	2%
	Maximum slope of flared sides	10%	10%
	Minimum ramp width	36"	48"
	Minimum landing length	36"	48"
	Minimum landing width		48"
	Maximum gutter slope	5%	5%
	Changes in level	Flush	Flush
	Truncated domes	Full depth and width	24" min.
Diagonal (at apex)	Maximum slope of ramps	8.33%	Not allowed except in alterations
	Maximum cross-slope of ramps	2%	2%
	Maximum slope of flared sides	10%	2%
	Minimum ramp width	36"	48"
	Minimum landing length	36"	48"
	Minimum landing width		48"
	Maximum gutter slope	5%	2%
	Changes in level	Flush	Flush
	Minimum clear space		48"

Table 6.1 continued

Curb Ramp Type	Characteristic	ADA Standards	PROWAG
Parallel and combination	Maximum slope of ramps	8.33%	8.3%
	Maximum cross-slope of ramps	2%	2%
	Maximum slope of flared sides	10%	
	Minimum ramp width	36"	48"
	Minimum landing length	36"	
	Minimum landing width		48"
	Minimum landing slope		2%
	Maximum gutter slope	5%	5%
	Changes in level	Flush	Flush
	Truncated domes	Full depth and width	24"
Curb extensions and built-up	Maximum slope of ramps	8.33%	8.3%
	Maximum cross-slope of ramps	2%	2%

A single ramp at the apex requires users to take a longer, more circuitous travel path to the other side and causes users to travel towards the center of the intersection where they may be in danger of getting hit by turning cars; being in the intersection longer exposes the user to greater risk of being hit by vehicles. A single ramp at the apex should be avoided in new construction and may be used only for alterations where a design exception is granted because of existing utilities and other significant barriers. In all cases, reducing the curb radius makes ramp placement easier.

Blended Transitions

Blended transitions are situations where either the entire sidewalk has been brought down to the street or crosswalk level, or the street has been brought up to the sidewalk level. They work well on large radius corners where it is difficult to line up the crosswalks with the curb ramps, but have drawbacks. Children, persons with cognitive impairments, and guide dogs may not distinguish the street edge. Turning vehicles may also encroach onto the sidewalk. For these reasons, bollards, planting boxes, or other intermittent barriers should be installed to prevent cars from traveling on the sidewalk. Detectable warnings should also be placed at the edge of the sidewalk to alert pedestrians with visual impairments of the transition to the street. Municipalities should follow the standards and guidelines for curb ramps provided in Table 6.1.

Detectable Warnings

Because a curb ramp removes the curb that visually impaired persons use to identify the location of a street, a detectable warning surface must be placed at the back of the curb. This detectable strip should be as wide as the ramp and a minimum of 24 inches deep. One corner should be located at the back of the curb and the other corner may be up to 5 feet from the back of the curb. These strips are most effective when adjacent to smooth pavement so the difference is easily detected. Color contrast is needed so partially sighted people can see them.

The ADAAG standards for detectable warnings are as follows.

- General: Detectable warnings shall consist of a surface of truncated domes and shall meet standards for size, spacing,

contrast and edges

- Base diameter: 0.9 inches minimum; 1.4 inches maximum
- Top diameter: 50 percent of base diameter minimum to 65 percent maximum
- Height: 0.2 inches
- Center-to-center spacing: 1.6 inches minimum to 2.4 inches maximum
- Base-to-base spacing: 0.65 inches minimum
- Visual contrast: light on dark, or dark on light with adjacent walking surface
- Platform edges: 24 inches wide and shall extend the full public use area of the platform

PROWAG best practices include the following.

- Width: as wide as the ramp and 24 inches deep
- Location: one corner at back of the curb, the other corner up to 5 feet from back of curb
- Used at
 - The edge of depressed corners
 - The border of raised crosswalks and intersections
 - The base of curb ramps
 - The border of medians
 - The edge of transit platforms and where railroad tracks cross the sidewalk

Signals

Signalized street crossings require special consideration of people with disabilities. The following text provides guidance to do that.

Crossing Times

In planning for people with disabilities, slower speeds must be considered. This is critical in setting the timing of the walk phase of signalized intersections. The Manual on Uniform Traffic Control Devices (MUTCD) requires that transportation agencies use an assumed walking speed of 3.5 feet/second for signal timing. In situations where a large number of older adults or persons with disabilities cross, this may be inadequate to meet their needs. Some cities instead use 2.8 feet/second.

Cities may also use PUFFIN (Pedestrian-User-Friendly-Intelligent) traffic signals to ensure that all pedestrians have adequate time to cross. PUFFIN crossings use infrared monitors to detect the presence of pedestrians in the crosswalk, and will hold the signal red for cross traffic until the pedestrian has left the crosswalk. PUFFIN crossings help slower pedestrians, but also help the flow of traffic because they allow the normal pedestrian design speed to be set at a higher level.

Pedestrian-Activated Push Buttons

Pedestrian-activated traffic controls require pedestrians to push a button to activate a walk signal. As noted in Chapter 7, “Pedestrian Crossings,” pedestrian-activated signals are generally discouraged. The “WALK” signal should automatically come on except under circumstances described in that chapter. Where pedestrian-activated traffic controls exist, they should be located as close as possible to curb ramps without reducing the width of the path. The buttons should be at a level that is easily reached by people in wheelchairs near the top of the ramp. The U.S. Access Board guidelines recommend buttons raised above or flush with their housing and large enough (a minimum of 2 inches) for people with visual impairments to see them. The buttons should also be easy to push.



*Pedestrian push button placement
(Credit: Michele Weisbart)*

Accessible Pedestrian Signals (APS)

Wayfinding for pedestrians with visual impairments is significantly improved with the use of APS at signalized intersections. In fact, APS are the most commonly requested accommodation under Section 504 of the Rehabilitation Act of 1973. APS communicate information about

pedestrian timing in non-visual formats such as audible tones, verbal messages, and/or vibrating surfaces. Verbal messages provide the most informative guidance. These devices should be installed close to the departure location and on the side away from the center of the intersection. Since they are typically only audible 6 to 12 feet from the push button, 10 feet should separate two APS devices on a corner. If two accessible pedestrian pushbuttons are placed less than 10 feet apart or on the same pole, each accessible pedestrian pushbutton shall be provided with a pushbutton locator tone, a tactile arrow, a speech walk message for the WALKING PERSON (symbolizing WALK) indication, and a speech pushbutton information message. Volumes of the walk indication and push button locator tone shall automatically adjust in response to ambient sound.

LAND USE AND SIDEWALK DESIGN GUIDELINES

The sidewalk design guidelines in this chapter integrate design and land use to provide safe and convenient passage for pedestrians. Sidewalks should have adequate walking areas and provide comfortable buffers between pedestrians and traffic. These guidelines will ensure sidewalks in all development and redevelopment provide access for people of all ages and physical abilities.

Sidewalks will vary according to the type of street. A local street with residences will require different sidewalk dimensions than a boulevard with commercial establishments. The descriptions below indicate the type of pedestrian activity expected at each of the specified land uses. The graphics (credit Marty Bruinsma) illustrate the minimum widths of the sidewalk zones for each of the contexts. The matrix in the following section provides specific minimum requirements for the four sidewalk zones according to combinations of land use and street classifications.

Low / Medium Density Residential

These streets are typically quieter than others and generally do not carry transit vehicles or high volumes of traffic. Pedestrians require a pleasant walking environment within these neighborhoods, as well as to access land uses and transit on nearby streets. Of the four sidewalk zones, the furniture zone is often the widest, to provide room for street trees.

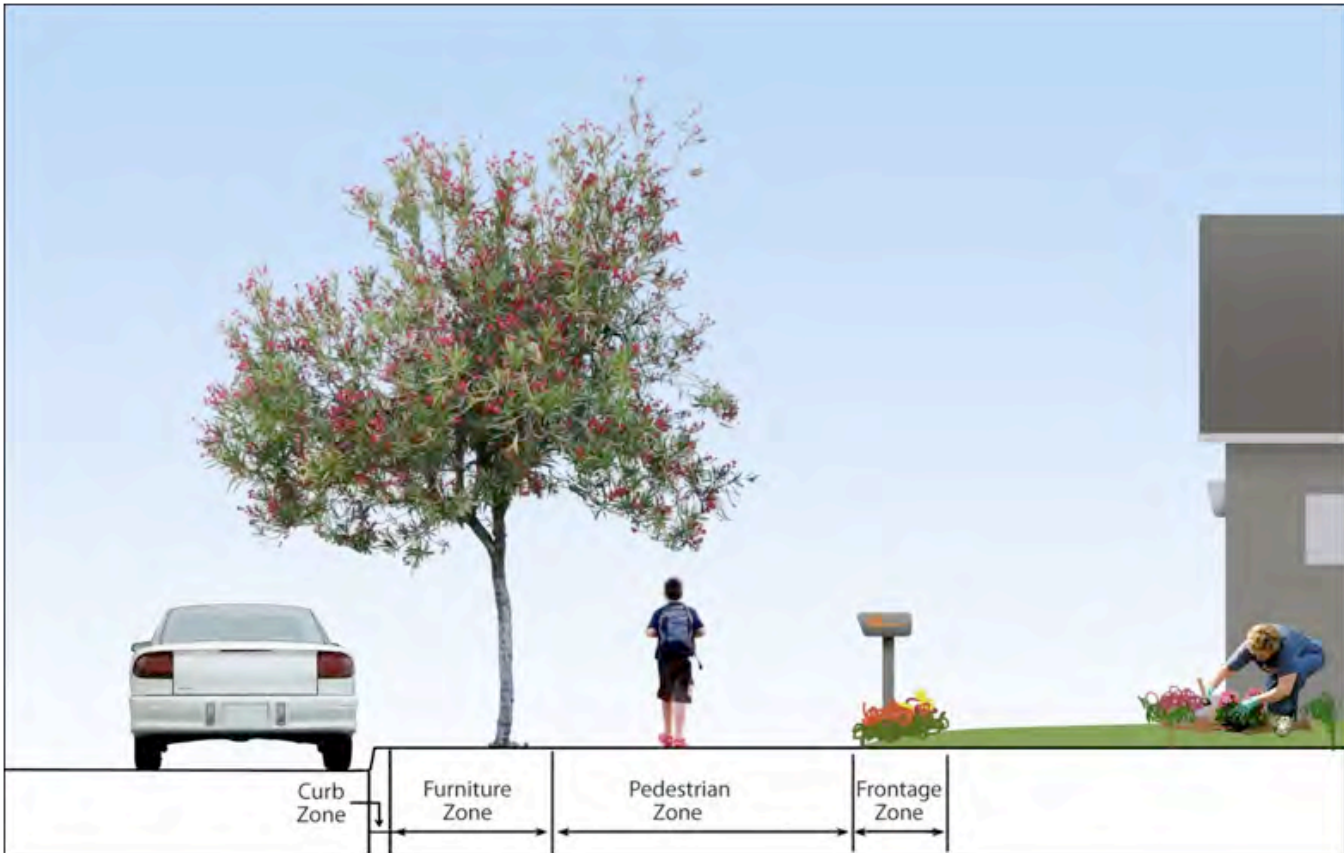

Medium / High Density Residential

These streets support greater volumes of pedestrians. Streets with transit service require good pedestrian links to bus stops. The pedestrian zone should be wider than in low/medium density residential.

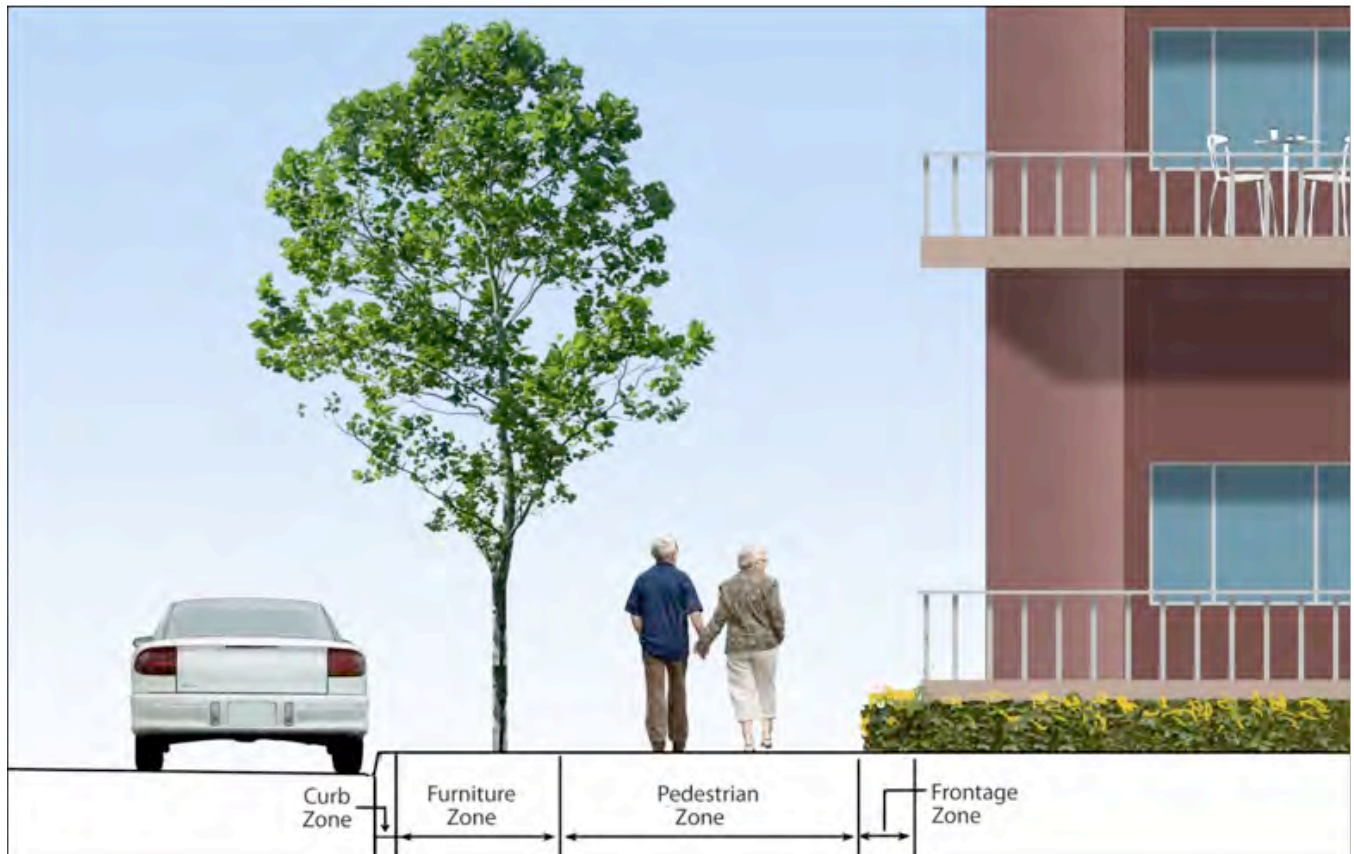

Neighborhood Commercial

These streets often have grocers, laundromats, drug stores, and other neighborhood-serving retail establishments. Sidewalks in neighborhood commercial areas should accommodate pedestrians walking from residences to stores. Of the four sidewalk zones, the pedestrian zone should be the widest, with a generous frontage zone to provide room for features next to buildings such as newspaper boxes. These sidewalks should also be designed with the understanding that cars will cross sidewalks as they enter and exit commercial driveways.

General / Regional Commercial

These streets have retail, office, civic, and recreational uses concentrated along boulevards and avenues. Transit service runs along these streets and pedestrians need buffers from traffic. Of the four sidewalk zones, the pedestrian and furniture zones are favored. These sidewalks also should be designed with the understanding that a significant number of cars will cross sidewalks as they enter and exit commercial driveways.

Mixed / Multi-use

The sidewalks along these streets should support significant pedestrian volumes due to their integrated nature and higher densities. Of the four sidewalk zones, the pedestrian and frontage zones will be favored. Transit service runs along these streets and sidewalks will require buffers from traffic.

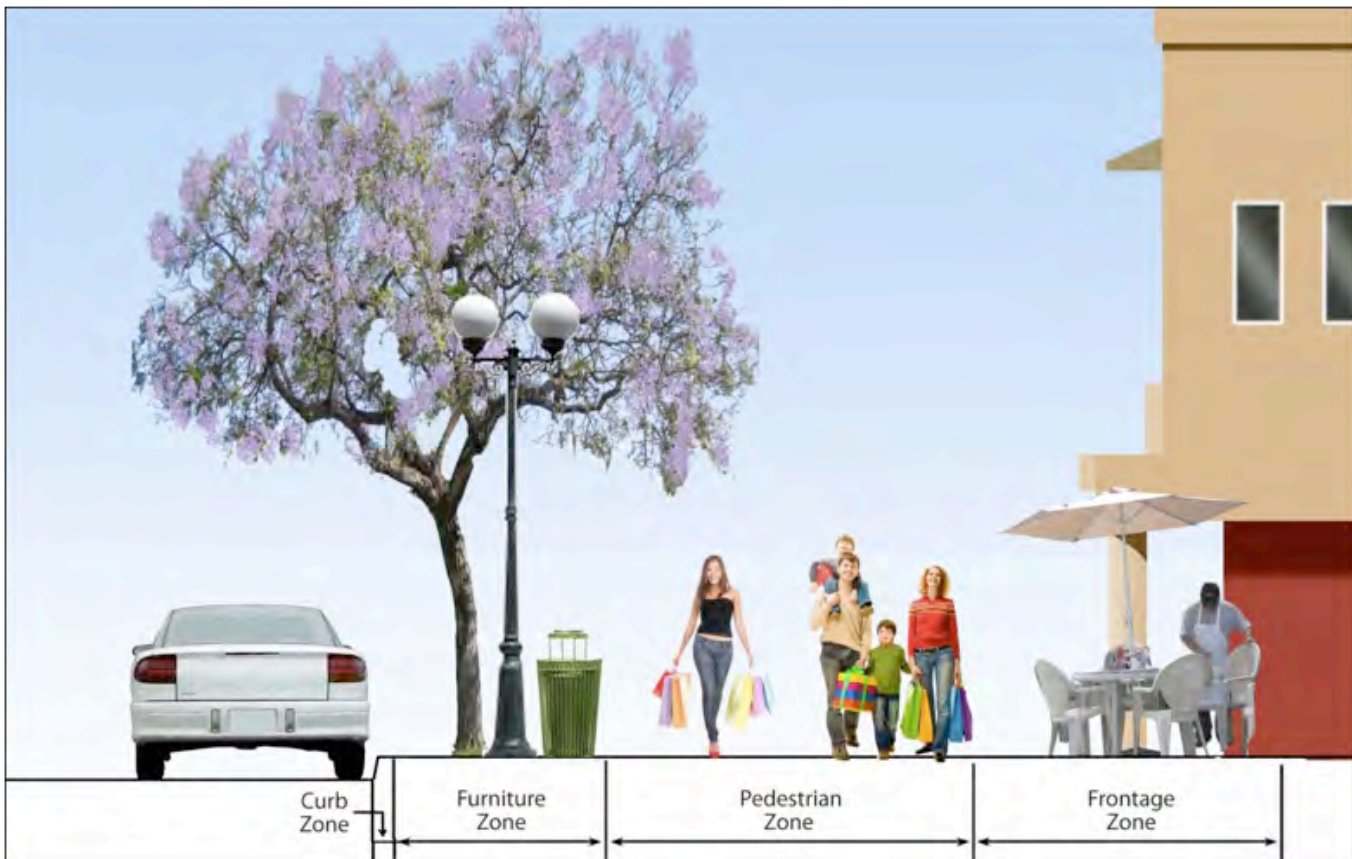

Industrial

Industrial streets are zoned for manufacturing, office warehousing, and distribution. Pedestrian volumes are likely to be lower here given that these land uses typically employ fewer people per square foot than general commercial areas. Employees will need good sidewalks to get to work.

Downtown Core / Mainstreet

The downtown core or Main Street is a pedestrian-oriented area. This is where the greatest numbers of pedestrians are encouraged and expected. The downtown core serves as the retail, restaurant, and entertainment center of a community. This area will need the widest sidewalks, the widest crosswalks, the brightest street lighting, the most furnishings, and other features that will enhance the pedestrian environment. Of the four sidewalk zones, the pedestrian and frontage zones will be favored, with a furniture zone wide enough for street trees.

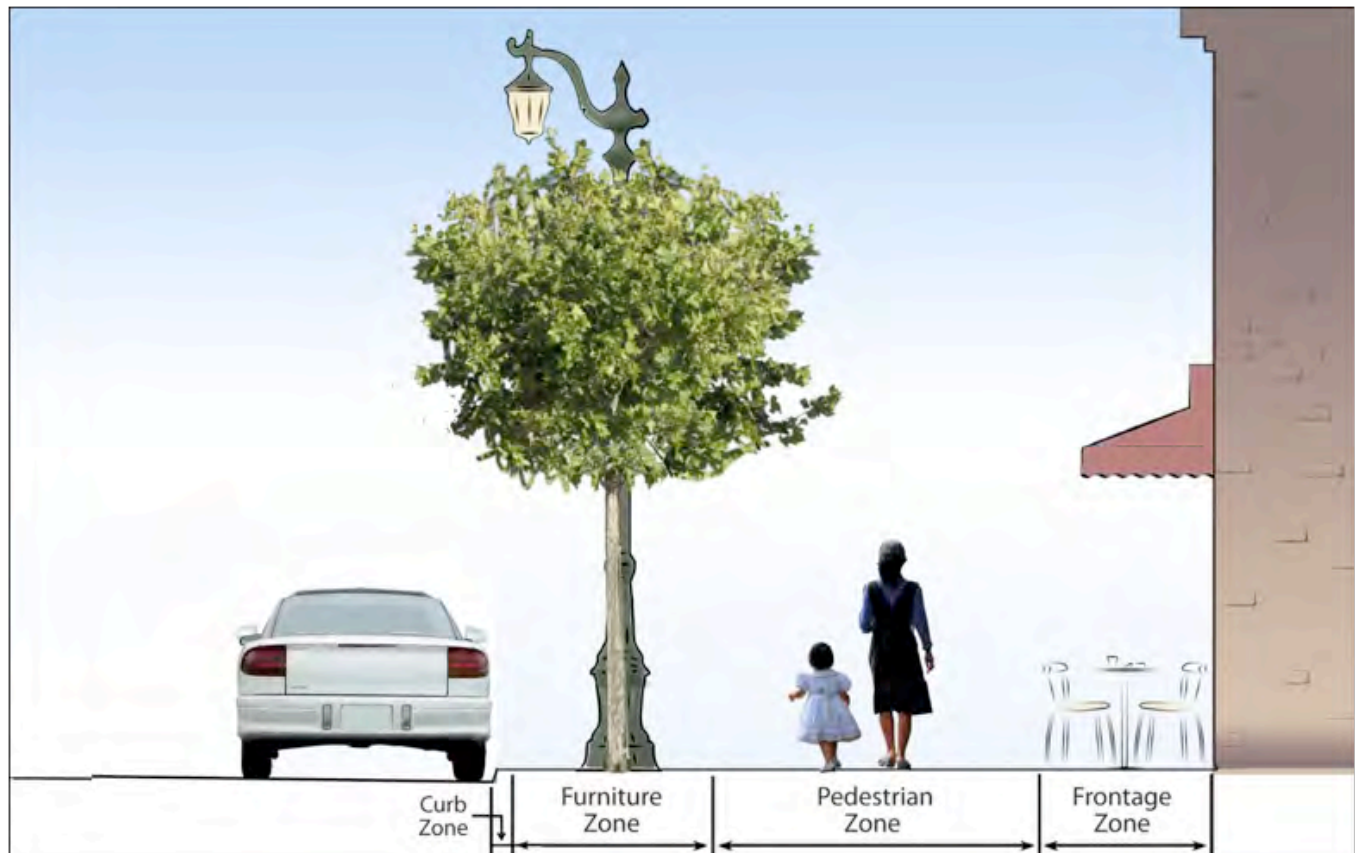

Office Park

These streets are home to national and regional offices of financial institutions, government, large companies, and other uses. Cities can expect pedestrians during the morning and evening commutes walking to and from their cars. Visitors will use the sidewalks throughout the day and employees will need them during the lunch hour. The furniture zone should provide adequate buffer from parking lots.

Public Facilities

Public facilities streets, particularly streets near schools, libraries, and civic centers, require special attention and treatment. High pedestrian volumes are expected during peak times, such as school pick-up and drop-off, and during the morning and evening commute hours. Sidewalk design should accommodate these peak travel times and include adequate furniture zones to buffer pedestrians from the street. Public facilities are located in various types of streets ranging from local streets to boulevards with transit service.

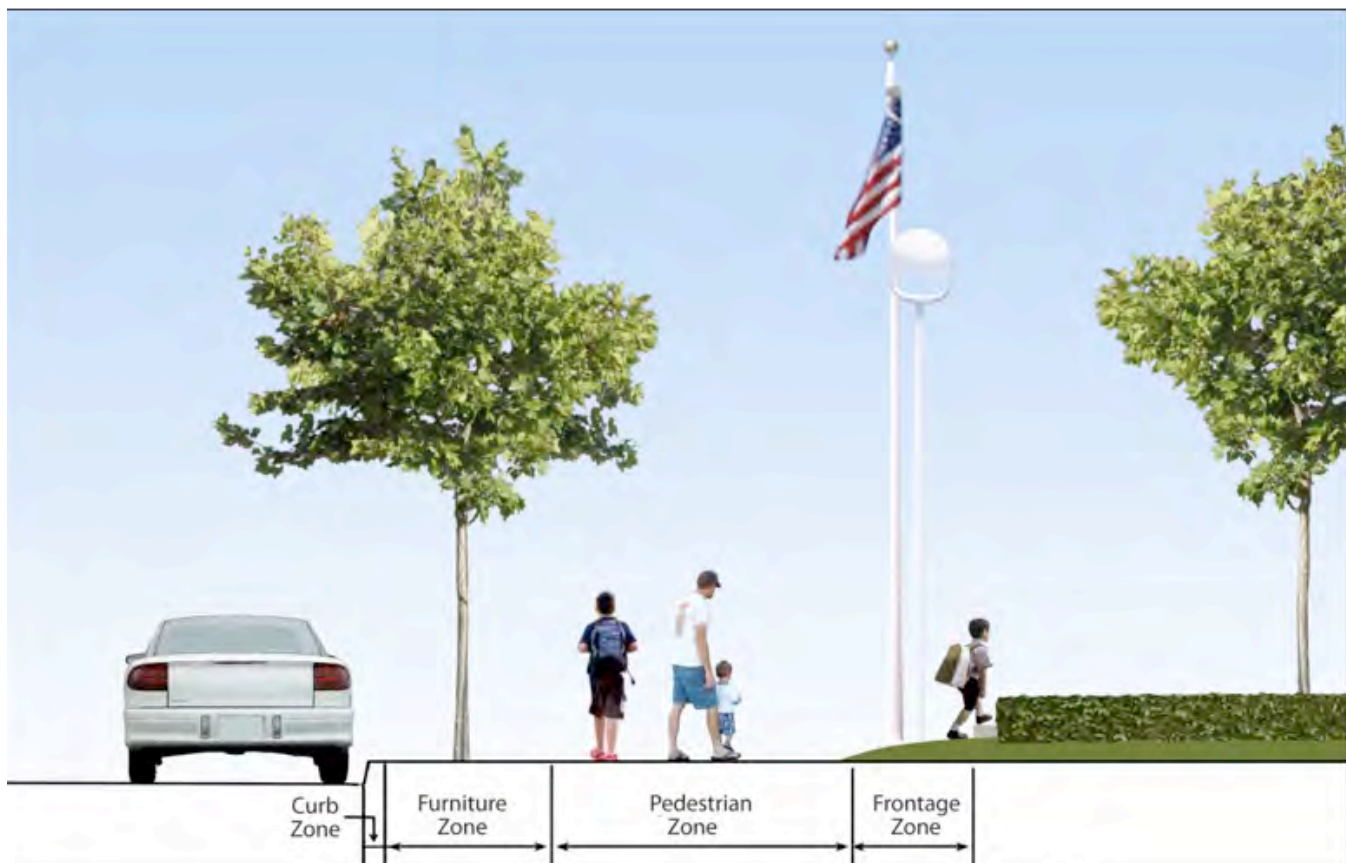

DESIGN SPECIFICATIONS BY ROADWAY TYPE AND LAND USE

Table 6.2 lists minimum widths for the frontage, pedestrian, furniture, and curb zones, as well as minimum total widths. These minimums should not be considered the design width; in many cases, wider zones will be needed.

Table 6.2 Sidewalk Zone Widths for Each Land Use Context

	Boulevard	Avenue	Street
Low / Medium-Low Density Residential	Not applicable	Frontage: 18" Pedestrian: 5' Furniture: 4', 6'-8' at bus stops and where large trees are desired Curb: 6" Min. Width: 11'	Frontage: 18" Pedestrian: 5' Furniture: 4' Curb: 6" Min. Width: 11'
Med / High Density Residential	Frontage: 18" Pedestrian: 6' Furniture: 5', 6'-8' at bus stops and where large trees are desired Curb: 6" Min. Width: 13'	Frontage: 18" Pedestrian: 6' Furniture: 5', 6'-8' at bus stops and where large trees are de- sired Curb: 6" Min. Width: 13'	Frontage: 18" Pedestrian: 6' Furniture: 4', 6'-8' at bus stops and where large trees are de- sired Curb: 6" Min. Width: 12'
Neighborhood Commercial	Not applicable	Frontage: 18" Pedestrian: 6' Furniture: 5', 6'-8' at bus stops and where large trees are de- sired Curb: 6" Min. Width: 13'	Frontage: 18" Pedestrian: 6' Furniture: 4', 6'-8' at bus stops and where large trees are de- sired Curb: 6" Min. Width: 12'
General Commercial	Frontage: 18" Pedestrian: 6' Furniture: 5', 6'-8' at bus stops and where large trees are desired Curb: 6" Min. Width: 13'	Frontage: 18" Pedestrian: 6' Furniture: 5', 6'-8' at bus stops and where large trees are de- sired Curb: 6" Min. Width: 13'	Not applicable
Mixed / Multi-use	Frontage: 30", 8' with cafe seating Pedestrian: 6' Furniture: 5', 6'-8' at bus stops and where large trees are desired Curb: 6" Min. Width: 14'	Frontage: 30", 8' with cafe seating Pedestrian: 6' Furniture: 4', 6'-8' at bus stops and where large trees are de- sired Curb: 6" Min. Width: 13'	Frontage: 18" Pedestrian: 6' Furniture: 4' Curb: 6" Min. Width: 12'

Table 6.2 continued

	Boulevard	Avenue	Street
Industrial	Frontage: 18" Pedestrian: 5' Furniture: 5' Curb: 18" Min. Width: 13'	Frontage: 18" Pedestrian: 5' Furniture: 4' Curb: 18" Min. Width: 12'	Frontage: 18" Pedestrian: 5' Furniture: 4' Curb: 18" Min. Width: 12'
Downtown Core / Main Street	Frontage: 30", 8' with cafe seating Pedestrian: 6' Furniture: 5', 6'-8' at bus stops and where large trees are desired Curb: 6" Min. Width: 14'	Frontage: 30", 8' with cafe seating Pedestrian: 6' Furniture: 5', 6'-8' at bus stops and where large trees are desired Curb: 6" Min. Width: 14'	Frontage: 30", 8' with cafe seating Pedestrian: 6' Furniture: 5' Curb: 6" Min. Width: 14'
Transit-Oriented Districts	Frontage: 30" Pedestrian: 8' Furniture: 5', 6'-8' at bus stops and where large trees are desired Curb: 6" Min. Width: 16'	Frontage: 30" Pedestrian: 8' Furniture: 5', 6'-8' at bus stops and where large trees are desired Curb: 6" Min. Width: 16'	Frontage: 18" Pedestrian: 6' Furniture: 5', 6'-8' at bus stops and where large trees are desired Curb: 6" Min. Width: 13'
Office Park	Frontage: 18" Pedestrian: 5' Furniture: 5' Curb: 6" Min. Width: 12'	Frontage: 18" Pedestrian: 5' Furniture: 5' Curb: 6" Min. Width: 12'	Not applicable
Public Facilities	Frontage: 30" Pedestrian: 8' Furniture: 5', 6'-8' at bus stops and where large trees are desired Curb: 6" Min. Width: 16'	Frontage: 30" Pedestrian: 8' Furniture: 5', 6'-8' at bus stops and where large trees are desired Curb: 6" Min. Width: 16'	Frontage: 18" Pedestrian: 6' Furniture: 5', 6'-8' at bus stops and where large trees are desired Curb: 6" Min. Width: 13'

General Guidelines

The land uses included in the previous table cover those of most municipalities. For those few areas not covered, the following list provides general guidelines for sidewalks:

- The recommended minimum frontage zone width is 18 inches.
- The recommended minimum pedestrian zone width is 5 feet.
- The recommended minimum curb zone width is 6 inches or 18 inches where pedestrian or freight loading is expected and may conflict with obstacles in the furniture zone.
- The recommended minimum furniture zone width is 4 feet and 6 feet to 8 feet where bus stops exist.
- Low curbs (3 to 4 inches high) reduce the division between the traveled way and the sidewalk. They are favored in areas with significant pedestrian traffic. Low curbs also improve the geometry and feasibility of providing two perpendicular curb ramps per corner.

Some judgment may be needed on a case-by-case basis to establish actual widths of each of the four zones.

FOR MORE INFORMATION

- Primary: ADAAG/PROWAG
- Secondary:
 - MUTCD
 - AASHTO "Green Book"
 - FHWA's Designing Sidewalks and Trails for Access
 - NCHRP Project 20-7 (232) ADA Transition Plans: Guide to Best Management Practices
 - NCHRP Project 3-62, Guidelines for Accessible Pedestrian Signals

Chapter 7. PEDESTRIAN CROSSINGS

INTRODUCTION.....	7-2
ESSENTIAL PRINCIPLES OF PEDESTRIAN CROSSINGS.....	7-3
PERFORMANCE MEASURES.....	7-5
PEDESTRIAN CROSSING TOOLBOX.....	7-5
Marked Crosswalks.....	7-6
Raised Crossing Islands/Medians.....	7-9
Raised Crosswalks.....	7-12
Curb Extensions.....	7-12
Pedestrian 'Scrambles'.....	7-14
Signs.....	7-15
Advanced Yield/Stop Lines.....	7-16
Lighting.....	7-16
Pedestrian Hybrid Beacon.....	7-18
Rectangular Rapid Flash Beacon (RRFB).....	7-18
Pedestrian Toolbox for Railroad Crossings.....	7-19



INTRODUCTION

Walking requires two important features in the built environment: people must walk along streets and they must get across streets. Crossing a street should be easy, safe, convenient, and comfortable. While pedestrian behavior and intersection or crossing design affect the street crossing experience, motorist behavior (whether and how motorists stop for pedestrians) is the most significant factor in pedestrian safety.

A number of tools exist to improve pedestrian safety and to make crossing streets easier. Effective traffic management can address concerns about traffic speed and volume. A motorist driving more slowly has more time to see, react, and stop for a pedestrian. The number of pedestrians also influences motorists; in general, motorists are more aware of pedestrians when more people walk. Most tools to address crossing challenges are engineering treatments, but tools from the enforcement, education, and planning toolboxes are also important.

Providing marked crosswalks is only one of the many possible engineering measures. When considering how to provide safer crossings for pedestrians, the question should not be: “Should I provide a marked crosswalk?” Instead, the question should be: “What are the most effective measures that can be used to help pedestrians safely cross the street?” Deciding whether to mark or not mark crosswalks is only one consideration in creating safe and convenient pedestrian crossings.

This chapter describes a number of measures to improve pedestrian crossings, including marked and unmarked crosswalks, raised crossing islands and medians, and lighting.



Crossings are a necessary part of the pedestrian experience (Credit: Sky Yim)

ESSENTIAL PRINCIPLES OF PEDESTRIAN CROSSINGS

The following principles should be incorporated into every pedestrian crossing improvement:

- Pedestrians must be able to cross roads safely. Cities have an obligation to provide safe and convenient crossing opportunities.
- The safety of all street users, particularly more vulnerable groups, such as children, the elderly, and those with disabilities, and more vulnerable modes, such as walking and bicycling, must be considered when designing streets.
- Pedestrian crossings must meet accessibility standards and guidelines.



*Curb extensions and median make crossing four-lane streets safer and more manageable
(Credit: Dan Burden)*

Real and perceived safety must be considered when designing crosswalks—crossing must be “comfortable.” A “safe” crossing that no one uses serves no purpose.

- Crossing treatments that have the highest crash reduction factors (CRFs) should be used when designing crossings.
- Safety should not be compromised to accommodate traffic flow.
- Good crossings begin with appropriate speed. In general, urban arterials should be designed to a maximum of 30 mph or 35 mph (note: 30 mph is the optimal speed for moving motor vehicle traffic efficiently).
- Every crossing is different and should be selected and designed to fit its unique environment.

The following issues should also be considered when planning and designing crossings:

- Ideally, uncontrolled crossing distances should be no more than 21 feet, which allows for one 11-foot lane and one 10-foot lane. Ideally, streets wider than 40 feet should be divided (effectively creating two streets) by installing a median or two crossing islands.
- The number of lanes should be limited to a maximum of three lanes per direction on all roads (plus a median or center turn lane).
- There must be a safe, convenient crossing at every transit stop.
- Double (or triple) left or right turns concurrent (permissive) with pedestrian crossings at signalized intersections must never be allowed.
- Avoid concurrent movements of motor vehicles and people at signalized intersections.
- People should never have to wait more than 90 seconds to cross at signalized intersections.
- Pedestrian signals should be provided at all signalized crossings where pedestrians are allowed.



Lively streets with many pedestrians indicate a walkable neighborhood: Hong Kong (Credit: Ryan Snyder)

PERFORMANCE MEASURES

Performance measures establish how well a crossing is performing. In all cases, baseline data should be collected to allow for before and after analysis. Performance measures for pedestrian crossings include the following:

The number of pedestrians crossing at a particular crossing location goes up.

- The pedestrian crash rates go down (for an accurate determination, entire corridors should be analyzed since crashes at any one location may be infrequent).
- Pedestrian fatalities and serious injuries should decrease.

The numbers of children, seniors, and people with disabilities crossing the street should reflect their percentage in the larger population.

- The speed of motorists either turning at an intersection or traveling at a mid-block crossing goes down.
- Motorists do not block intersections (including crosswalks).
- At uncontrolled intersections, the percentage of motorists who stop for pedestrians goes up (measure compliance with stop or yield requirement in local vehicle code).

PEDESTRIAN CROSSING TOOLBOX

Many engineering measures may be used at a pedestrian crossing, depending on site conditions and potential users. Marked crosswalks are commonly used at intersections and sometimes at mid-block locations. Marked crosswalks are often the first measure in the toolbox followed by a series of other measures that are used to enhance and improve marked crosswalks. The decision to mark a crosswalk should not be considered in isolation, but rather in conjunction with other measures to increase awareness of pedestrians. Without additional measures, marked crosswalks alone may not increase pedestrian safety, particularly on multi-lane streets.

Marked Crosswalks

Crosswalks are present by law at all intersections, whether marked or unmarked, unless the pedestrian crossing is specifically prohibited. At mid-block locations, crosswalks only exist where marked. At these non-intersection locations, the crosswalk markings legally establish the crosswalk. Crosswalks should be considered at mid-block locations where there is strong evidence that pedestrians want to cross there, due to origins and destinations across from each other and an overly long walking distance to the nearest controlled crossing. Marked crosswalks alert drivers to expect crossing pedestrians and direct pedestrians to desirable crossing locations. Although many motorists are unaware of their precise legal obligations at crosswalks, the California Vehicle Code requires drivers to yield to pedestrians in any crosswalk, whether marked or unmarked. Marking crosswalks at every intersection is not necessary or desirable.

Crosswalk Markings

According to the MUTCD, the minimum crosswalk marking shall consist of solid white lines. They shall not be less than 6 inches or greater than 24 inches in width.

Placement

The best locations to install marked crosswalks are

- All signalized intersections
- Crossings near transit locations
- Trail crossings
- High land use generators
- School walking routes
- When there is a preferred crossing location due to sight distance
- Where needed to enable comfortable crossings of multi-lane streets between controlled crossings spaced at convenient distances

Controlled Intersections

Intersections can be controlled by traffic signals or STOP signs. Marked crosswalks should be provided on all intersection legs controlled by traffic signals, unless the pedestrian crossing is specifically prohibited. Marked crosswalks may be considered at STOP-controlled intersections. Factors to be considered include high pedestrian volumes, high vehicle volumes, school zone location, high volume of elderly or disabled users, or other safety related criteria.

Uncontrolled Intersections and Mid-block Crosswalks

Intersections without traffic signals or STOP signs are considered uncontrolled intersections. The decision to mark a crosswalk at an uncontrolled location should be guided by an engineering study. Factors considered in the study should include vehicular volumes and speeds, roadway width and number of lanes, stopping sight distance and triangles, distance to the next controlled crossing, night time visibility, grade, origin-destination of trips, left turning conflicts, and pedestrian volumes. The engineering study should be based on the FHWA study, *Safety Effects of Marked Versus Unmarked Crosswalks at Uncontrolled Locations*. The following list provides some of the key recommendations from the study:

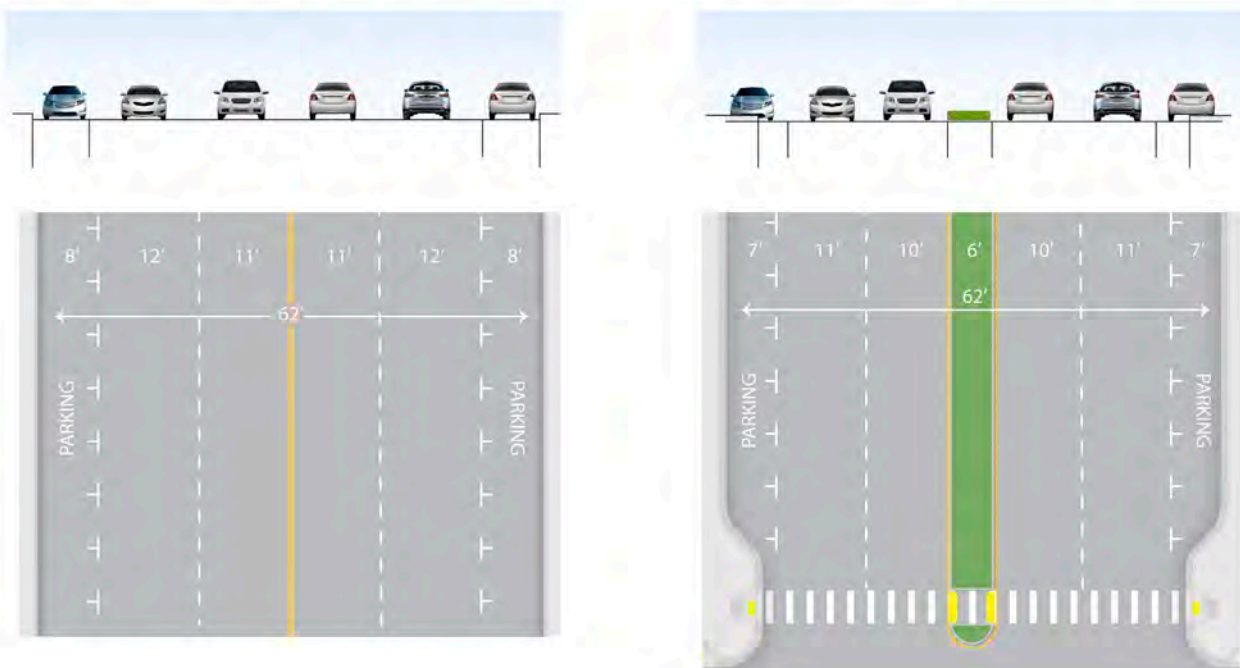

Uncontrolled crossings of four-lane streets can be difficult to cross without special treatments like medians and curb extensions (Credit: Michele Weisbart)

- It is permissible to mark crosswalks on two-lane roadways.
- On multi-lane roadways, marked crosswalks alone are not recommended under the following conditions (the other tools listed in this section can be considered to enhance the crosswalk):
 - ADT > 12,000 w/o median
 - ADT > 15,000 w/ median
 - Speeds greater than 40 mph
- Raised medians can be used to reduce risk.
- Signals or other treatments should be considered where there are many young and/or elderly pedestrians.

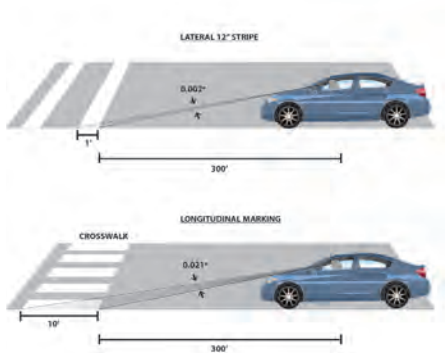

Longitudinal crosswalk markings are more visible than lateral crosswalk markings (Credit: Michele Weisbart)

Frequency of Marked Crosswalks at Uncontrolled Locations

Marked crosswalks should be spaced so people can cross at preferred locations. If people are routinely crossing streets at non-preferred locations, consideration should be given to installing a new crossing. Pedestrians need crossings with appropriate devices (islands, curb extensions, advanced yield lines, etc.) of multi-lane streets where there are strong desire lines. Along urban streets, a well-designed crossing should be provided at least every 1/8 mile.



Typical crosswalk markings: Continental, Ladder, Staggered Continental (Credit: Michele Weisbart)

High-Visibility Crosswalks

Because of the low approach angle at which pavement markings are viewed by drivers, the use of longitudinal stripes in addition to or in place of transverse markings can significantly increase the visibility of a crosswalk to oncoming traffic. While research has not shown a direct link between increased crosswalk visibility and increased pedestrian safety, high-visibility crosswalks have been shown to increase motorist yielding and channelization of pedestrians, leading the Federal Highway Administration to conclude that high-visibility pedestrian crosswalks have a positive effect on pedestrian and driver behavior.

Colored and stamped crosswalks should only be used at controlled locations.



Example of staggered continental crosswalk (Credit: Michael Ronkin)

Staggered longitudinal markings reduce maintenance since they avoid vehicle wheel paths.

Crosswalks and Accessibility

The Pedestrian Access Route continues through the crosswalk and must conform to the surface condition, width, and slope requirements discussed in Chapter 6, “Universal Pedestrian Access.”

Longitudinal crosswalk markings provide the best visibility for pedestrians with limited vision.

Decorative crosswalk pavement materials should be chosen with care to ensure that smooth surface conditions and high contrast with surrounding pavement are provided. Textured materials within the crosswalk are not recommended. Without reflective materials, these treatments are not visible to drivers at night. Decorative pavement materials often deteriorate over time and become a maintenance problem while creating uneven pavement. The use of color or material to delineate the crosswalks as a replacement of retro-reflective pavement marking should not be used, except in slow speed districts where intersecting streets are designed for speeds of 20 mph or less.



Decorative crosswalk treatments made of distinctive materials can become uneven over time (Credit: Ryan Snyder)

Raised Crossing Islands/Medians

Raised islands and medians are the most important, safest, and most adaptable engineering tool for improving street crossings. Note on terminology: a median is a continuous raised area separating opposite flows of traffic. A crossing island is shorter and located just where a pedestrian crossing is needed. Raised medians and crossing islands



*Staggered median crossing
(Credit: Marcel Schmaedick)*

are commonly used between intersections when blocks are long (500 feet or more in downtowns) and in the following situations:

- Speeds are higher than desired
- Streets are wide
- Traffic volumes are high
- Sight distances are poor

Raised islands have nearly universal applications and should be placed where there is a need for people to cross the street. They are also used to slow traffic.

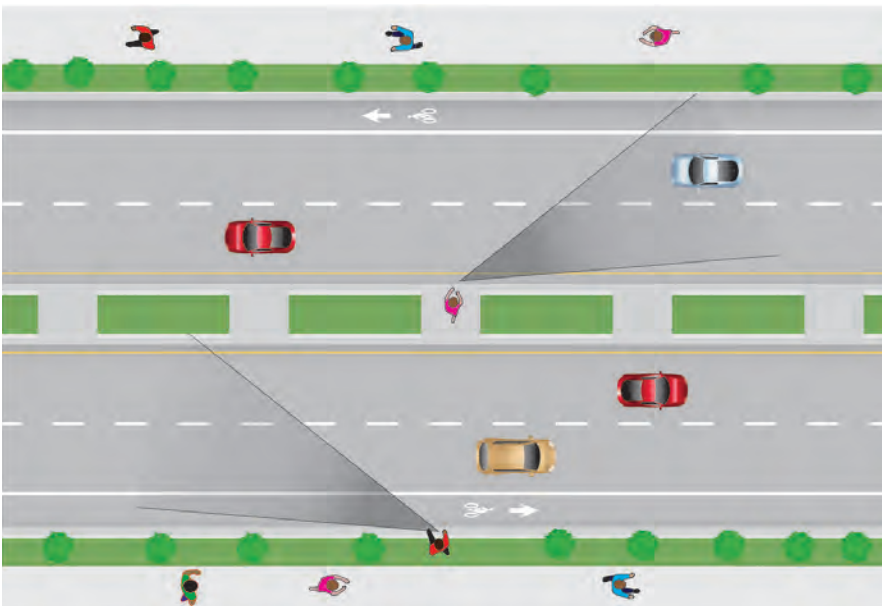

*Medians and crossing islands
allow pedestrians to complete
the crossing in two stages
(Credit: Michele Weisbart)*

Reasons for Efficacy

Their use changes a complex task, crossing a wide street with traffic coming from two opposing directions all at once, into two simpler and smaller tasks. With their use, conflicts occur in only one direction at a time, and exposure time can be reduced from more than 20 seconds to just a few seconds.

On streets with traffic speeds higher than 30 mph, it may be unsafe to cross without a median island. At 30 mph, motorists travel 44 feet each second, placing them 880 feet out when a pedestrian starts crossing an 80-foot wide multi-lane road. In this situation, this pedestrian may still be in the last travel lane when the car arrives there; that car was not within view at the time he or she started crossing. With an island on multi-lane roadways, people would cross two or three lanes at a time instead of four or six. Having to wait for a gap in only one direction of travel at a time significantly reduces the wait time to cross. Medians and crossing islands have been shown to reduce crashes by 40 percent (Federal Highway Administration, *Designing for Pedestrian Safety* course).

As a general rule, crossing islands are preferable to signal-controlled crossings due to their lower installation and maintenance cost, reduced waiting times, and their safety benefits. Crossing islands are also used with road diets, taking four-lane undivided, high-speed roads down to better performing three-lane roadways (two travel lanes and a center turn lane); portions of the center turn lane can be dedicated to crossing islands. Crossing islands can also be used with signals.

Angled pedestrian crossings through pedestrian refuges (as shown in the adjacent photo) force pedestrians to look for oncoming vehicles.



*Angled median crossing
(Credit: Paul Zykovsky)*

*Multiple tools can be employed to improve uncontrolled crossings
(Credit: Dan Burden)*



*Crossing islands: Berkeley, CA
(Credit: Ryan Snyder)*

Where to Place Crossing Islands

Crossing islands are often used for trails, high pedestrian flow zones, transit stations, schools, work centers, and shopping districts.

Design Detail

Crossing islands, like most traffic calming features, perform best with both tall trees and low ground cover. This greatly increases their visibility, reduces surprise, and lowers the need for a plethora of signs. When curves or hill crests complicate crossing locations, median islands are often extended over a crest or around a curve to where motorists have a clear (six second or longer) sight line of the downstream change in conditions. Lighting of median islands is essential. The suggested minimum width of a crossing island is 6 feet. When used on higher speed roads, and where there is space available, inserting a 45-degree bend to the right helps orient pedestrians to the risk they encounter from motorists during the second half of their crossing.

Raised Crosswalks

Raised crosswalks slow traffic and put pedestrians in a more visible position. They are trapezoidal in shape on both sides and have a flat top where the pedestrians cross. The level crosswalk area must be paved with smooth materials; any texture or special pavements used for aesthetics should be placed on the beveled slopes, where they



*Raised crosswalk: University of North Carolina Campus, Chapel Hill, NC
(Credit: Ryan Snyder)*

will be seen by approaching motorists. They are most appropriate in areas with significant pedestrian traffic and where motor vehicle traffic should move slowly, such as near schools, on college campuses, in Main Street retail environments, and in other similar places. They are especially effective near elementary schools where they raise small children by a few inches and make them more visible.

Curb Extensions

Curb extensions extend the sidewalk or curb line out into the parking lane, which reduces the effective street width. Curb extensions significantly improve pedestrian crossings by reducing the pedestrian crossing distance, visually and physically narrowing the roadway, improving the ability of pedestrians and motorists to see each other, and reducing the time that pedestrians are in the street. Reducing street widths improves signal timing since pedestrians need less time to cross.

Motorists typically travel more slowly at intersections or mid-block locations with curb extensions, as the restricted street width sends a visual cue to slow down. Turning speeds are lower at intersections with curb extensions (curb radii should be as tight as is practicable). Curb extensions also prevent motorists from parking too close to the intersection.

Curb extensions also provide additional space for two curb ramps and for level sidewalks where existing space is limited, increase the pedestrian waiting space, and provide additional space for pedestrian push button poles, street furnishings, plantings, bike parking and other



*Curb extensions
(Credit: Michele Weisbart)*



*Example of curb extensions
(Credit: Marcel Schmaedick)*

amenities. A benefit for drivers is that extensions allow for better placement of signs (e.g., stop signs and signals).

Curb extensions are generally only appropriate where there is an on-street parking lane. Where street width permits, a gently tapered curb extension can reduce crossing distance at an intersection along streets without on-street parking, without creating a hazard. Curb extensions must not extend into travel lanes or bicycle lanes.

Curb extensions can impact other aspects of roadway design and operation as follows:

- May impact street drainage and require catch basin relocation
- May impact underground utilities
- May require loss of curbside parking, though careful planning often mitigates this potential loss, for example by relocating curbside fire hydrants, where no parking is allowed, to a curb extension
- May complicate delivery access and garbage removal
- May impact snow plows and street sweepers
- May affect the turning movements of larger vehicles such as school buses and large fire trucks



*Pedestrian scramble
(Credit: Dan Burden)*

Pedestrian ‘Scrambles’

Exclusive pedestrian phases (i.e. pedestrian ‘scrambles’) may be used where turning vehicles conflict with very high pedestrian volumes and pedestrian crossing distances are short. Although pedestrians can cross in any direction during the pedestrian phase, pedestrians typically have to wait for both vehicle phases before they get the walk signal again. This creates delay for pedestrians travelling straight, but can be mitigated by allowing pedestrians continuing along the same direction to get a WALK signal during the green signal phase and while turns are prohibited for traffic.



Signs

Signs can provide important information to improve road safety by letting people know what to expect, so they can react and behave appropriately. Sign use and placement should be done judiciously, as overuse breeds noncompliance and disrespect. Too many signs create visual clutter.

Regulatory signs, such as STOP, YIELD, or turn restrictions, require driver actions and can be enforced. Warning signs provide information, especially to motorists and pedestrians unfamiliar with an area.

Advance pedestrian warning signs should be used where pedestrian

crossings may not be expected by motorists, especially if there are many motorists who are unfamiliar with the area. The fluorescent yellow/green color is designated specifically for pedestrian, bicycle, and school warning signs (Section 2A.10 of the 2009 MUTCD) and should be used for all new and replacement installations. This bright color attracts the attention of drivers because it is unique.

Sign R1-5 should be used in conjunction with advance yield lines, as described below. Sign R1-6 may be used on median islands, where they will be more visible to motorists than signs placed on the side of the street, especially where there is on-street parking. Since California is a “yield” state, cities should use R1-5, R1-5a, and R1-6 signs.

All signs should be periodically checked to make sure that they are in good condition, free from graffiti, reflective at night, and continue to serve a purpose.

All sign installations need to comply with the provisions of the MUTCD.



*Advanced yield markings
(Credit: Sky Yim)*

Advanced Yield/Stop Lines

Stop lines are solid white lines 12 to 24 inches wide, extending across all approach lanes to indicate where vehicles must stop in compliance with a stop sign or signal. Advance stop lines reduce vehicle encroachment into the crosswalk and improve drivers’ view of pedestrians. At signalized intersections a stop line is typically set back between 4 and 6 feet.

At uncontrolled crossings of multi-lane roads, advance yield lines can be an effective tool for preventing multiple threat vehicle and pedestrian collisions. Section 3B.16 of the MUTCD specifies placing advanced yield markings 20 to 50 feet in advance of crosswalks, depending upon location-specific variables such as vehicle speeds, traffic control, street width, on-street parking, potential for visual confusion, nearby land uses with vulnerable populations, and demand for queuing space. Thirty feet is the preferred setback for effectiveness at many locations. This setback allows a pedestrian to see if a car in the second (or third) lane is stopping after a driver in the first lane has stopped.

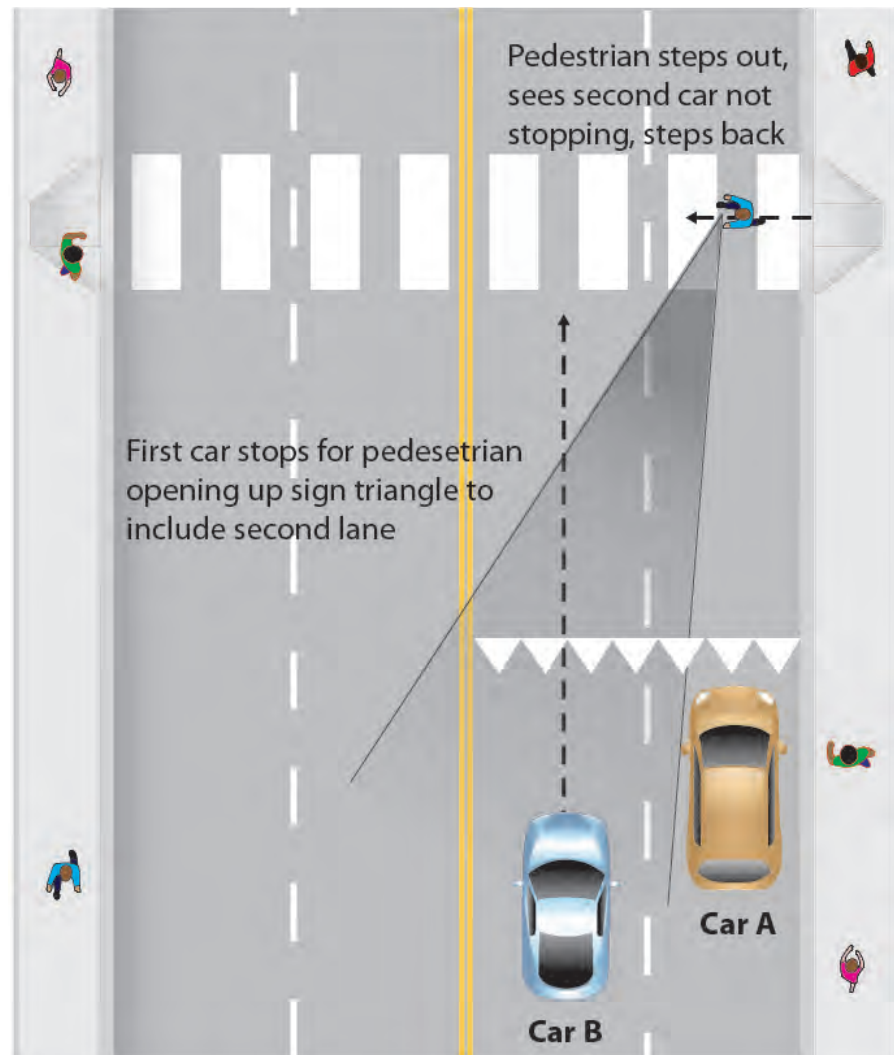

Advanced yield markings
(Credit: Michele Weisbart)

Lighting

Lighting is important to include at all pedestrian crossing locations for the comfort and safety of the road users. Lighting should be present at all marked crossing locations. Lighting provides cues to drivers to expect pedestrians earlier.

FHWA HT-08-053, *The Information Report on Lighting Design for Mid-block Crosswalks*, found that a vertical illumination of 20 lux in front of the crosswalk, measured at a height of 5 feet from the road surface, provided adequate detection distances in most circumstances. Although the research was constrained to mid-block placements of crosswalks, the report includes a brief discussion of considerations in lighting crosswalks co-located with intersections. The same principle applies at intersections. Illumination just in front of crosswalks creates optimal visibility of pedestrians.



Proper placement of crosswalk illumination (Credit: Michele Weisbart)

Other good guidance on crosswalk lighting levels comes from the Illuminating Engineering Society of North America (IESNA) intersection guidance to illuminate pedestrians in the crosswalk to vehicles (see the adjacent image). Crosswalk lighting should provide color contrast from standard roadway lighting.

Table 7.1 Recommended Illumination by Street Type

Functional Classification	Average Maintained Illumination at Pavement by Pedestrian Area Classification [FC]		
	High	Medium	Low
Major / Major (boulevard)	3.4 fc	2.6 fc	1.8 fc
Major / Collector (boulevard/avenue)	2.9 fc	2.2 fc	1.5 fc
Major / Local (avenue)	2.6 fc	2.0 fc	1.3 fc
Collector / Collector (avenue)	2.4 fc	1.8 fc	1.2 fc
Collector / Local (street)	2.1 fc	1.6 fc	1.0 fc
Local / Local (street)	1.8 fc	1.4 fc	0.8 fc

FC stands for “foot candle” and is defined as the amount of illuminance on a 1 square foot surface of which there is uniformly distributed flux of one lumen. ANSHESNA RP-8-00, “Roadway Lighting,” P. 15

Drivers		Pedestrians	
... will see this	... will do this	... will see this	... will do this
	Proceed with Caution		Push the Button to Cross
	Slow Down (pPedestrian has activated the push button)		Wait
	Prepare to Stop		Continue to Wait
	STOP! (Pedestrian in Crosswalk)		Start Crossing
	STOP! Proceed with Caution if Clear		Continue Crossing (Countdown Signal)
	Proceed if Clear		Push the Button to Cross

Pedestrian hybrid beacon phases (Credit: Michele Weisbart)

Pedestrian Hybrid Beacon

A pedestrian hybrid beacon is used to warn and control traffic at an unsignalized location so as to help pedestrians cross a street or highway at a marked crosswalk.

A pedestrian hybrid beacon can be used at a location that does not meet traffic signal warrants or at a location that meets traffic signal warrants but a decision has been made to not install a traffic control signal. A minimum number of 20 pedestrians per hour is needed to warrant installation. This is substantially less than the 93 minimum needed for a signal installation.

If beacons are used, they should be placed in conjunction with signs, crosswalks, and advanced yield lines to warn and control traffic at locations where pedestrians enter or cross a street or highway. A pedestrian hybrid beacon should only be installed at a marked crosswalk.

Installations should be done according to the MUTCD Chapter 4F, "Pedestrian Hybrid Beacons." The California MUTCD has not yet approved the beacons for use. Cities should follow the formal experimental process to use these.

Rectangular Rapid Flash Beacon (RRFB)

The RRFB uses rectangular-shaped high-intensity LED-based indications, flashes rapidly in a wig-wag "flickering" flash pattern, and is mounted immediately between the crossing sign and the sign's supplemental arrow plaque.



Rectangular rapid-flash beacon (Credit: SPOT Devices)

FHWA Evaluation of Results

The Office of Transportation Operations has reviewed available data and considers the RRFB to be highly successful for the applications tested (uncontrolled crosswalks). The RRFB offers significant potential safety and cost benefits because it achieves very high rates of compliance at a very low cost compared to other more restrictive devices such as full mid-block signalization. The components of the RRFB are not proprietary and can be assembled by any jurisdiction with off-the-shelf hardware. The FHWA believes that the RRFB has a low risk of safety or operational concerns. However, because proliferation of RRFBs in the roadway environment to the point that they become ubiquitous could decrease their effectiveness, use of RRFBs should be limited to locations with the most critical safety concerns, such as pedestrian and school crosswalks at uncontrolled locations, as tested in the experimentation.

At a recent meeting of the National Committee on Uniform Traffic Control Devices, the Signals Technical Committee voted to endorse the future inclusion of the RRFB for uncontrolled crosswalks into the MUTCD and recommended that FHWA issue an Interim Approval for RRFB. This Interim Approval allows agencies to install this type of flashing beacon, pending official MUTCD rulemaking.

Pedestrian Toolbox for Railroad Crossings

Pedestrian crossings of railroad tracks apply a special set of tools. In California, the California Public Utilities Commission should approve the design before application. The following are the primary tools to apply:

- Pedestrian gates
- Channelization of pedestrians through gates and across tracks
- Warning flashers
- Signs
- Audible signals

More details can be found in *Pedestrian Rail Crossings in California*, Richard Clark, California Public Utilities Commission, May 2008.

Chapter 8. BIKEWAY DESIGN

ESSENTIAL PRINCIPLES OF BIKEWAY DESIGN	8-2	INTERSECTIONS	8-19
PLANNING FOR A RANGE OF BIKEWAY USERS	8-2	Bikeway Markings at Intersections.....	8-19
BIKEWAY TYPES	8-4	Bike Signal Heads.....	8-20
Shared Roadways.....	8-5	Bicycle Signal Detection.....	8-21
Bicycle Boulevards.....	8-5	Bike Boxes.....	8-21
Shoulder Bikeways.....	8-6	Bicycle Countdowns.....	8-22
Bike Lanes.....	8-6	Leading Bicycle Intervals.....	8-22
Cycle Tracks.....	8-6	Two-Stage Turn Queue Boxes.....	8-22
Shared Use Paths.....	8-6	Colored Pavement Treatments.....	8-22
Bike Routes.....	8-7	Wayfinding.....	8-23
INTEGRATING WITH THE STREET SYSTEM	8-7	Bicycle Parking.....	8-24
DESIGN OF EACH BIKEWAY TYPE	8-9	Maintenance.....	8-24
Shared Roadways.....	8-9	IMPLEMENTATION	8-26
Bicycle Boulevards.....	8-11	Resurfacing.....	8-26
Shoulder Bikeways.....	8-13	Utility Work.....	8-27
Bike Lanes.....	8-14	Redevelopment.....	8-27
Cycle Tracks.....	8-17	Paved Shoulders.....	8-28
Shared Use Paths.....	8-18	ADDITIONAL RESOURCES	8-28



ESSENTIAL PRINCIPLES OF BIKEWAY DESIGN

The following principles inform the recommendations made in this chapter:

- Bicyclists should have safe, convenient, and comfortable access to all destinations.
- Every street is a bicycle street, regardless of bikeway designation.
- Street design should accommodate all types, levels, and ages of bicyclists.
- Bicyclists should be separated from pedestrians.
- Bikeway facilities should take into account vehicle speeds and volumes, with
 - Shared use on low volume, low-speed roads.
 - Separation on higher volume, higher-speeds roads.
- Bikeway treatments should provide clear guidance to enhance safety for all users.
- Since most bicycle trips are short, a complete network of designated bikeways has a grid of roughly ½ mile.

PLANNING FOR A RANGE OF BIKEWAY USERS

Many early bikeway designs assumed that bicyclists resemble pedestrians in their behavior. This led to undesirable situations: bicyclists being under-served by inadequate facilities, pedestrians resenting bicyclists in their space, and motorists being confused by bicyclists entering and leaving the traffic stream in unpredictable ways. Only under special circumstances (e.g., on shared-use paths or shared-space streets) should bicyclists and pedestrians share the same space.

Bicyclists operate a vehicle and are legitimate road users, but they are slower and less visible than motor vehicles. Bicyclists are also more vulnerable in a crash than motorists. They need accommodation on busy, high-speed roads and at complex intersections. In congested urban areas, bicyclists provided with well-designed facilities can often proceed faster than motorists.

Bicyclists use their own power, must constantly maintain their balance, and don't like to interrupt their momentum. Typical bicyclist speeds range from 10 to 15 mph, enabling them to make trips of up to 5



Plan bicycle facilities for various skill levels (Credit: Dan Burden)

miles in urban areas in about 25 minutes, the equivalent of a typical suburban commuter trip time. Bicyclists may wish to ride side-by-side so they can interact socially with a riding companion.

Well-designed bicycle facilities guide cyclists to ride in a manner that generally conforms to the vehicle code: in the same direction as traffic and usually in a position 3 to 4 feet from the right edge of the traveled way or parked cars to avoid debris, drainage grates, and other potential hazards. Cyclists should be able to proceed through intersections in a direct, predictable, and safe manner.

Cyclist skill level also provides a wide variety of speeds and expected behaviors. Several systems of bicyclist classification are used within the bicycle planning and engineering professions. These classifications can be helpful in understanding the characteristics and infrastructure preferences of different cyclists. However, these classifications may change in type or proportion over time as infrastructure and culture evolve. Bicycle infrastructure should use planning and designing options, from shared roadways to separate facilities, to accommodate as many user types as possible and to provide a comfortable experience for the greatest number of cyclists.



*Proficient bicycle rider
(Credit: Dan Burden)*



*Less-experienced riders prefer paths
(Credit: Dan Burden)*

A classification system developed by the City of Portland, Oregon, provides the following bicycle user types:

- **Strong and Fearless.** Bicyclists who will ride anywhere regardless of roadway conditions. These bicyclists can ride faster than other user types, prefer direct routes, and will typically choose roadways, even if shared with vehicles, over separate bicycle facilities such as paths. Very low percentage of the population.
- **Enthused and Confident.** This group encompasses intermediate cyclists who are mostly comfortable riding on all types of bicycle facilities but will usually prefer low traffic streets, bike lanes, or separate paths when available. They may deviate from a more direct route in favor of a preferred facility type. This group includes commuters, utilitarian cyclists, and recreational riders, and probably represents less than 10 percent of the population.
- **Interested but Concerned.** This user type makes up the bulk (likely between half and two-thirds) of the cycling or potential cycling population. They are cyclists who typically ride only on low traffic streets or paths under favorable conditions and weather. They perceive traffic and safety as significant barriers towards increased use of cycling. These cyclists may become “Enthused and Confident” with encouragement, education, and experience.
- **No Way, No How.** People in this category are not cyclists; they perceive severe safety issues with riding in traffic and will never ride a bicycle under any circumstances. But some may eventually give cycling a second look and may progress to the user types above. This group likely comprises something between a quarter and a third of the population.

BIKEWAY TYPES

A designated bikeway network provides a system of facilities that offers enhancement or priority to bicyclists over other roadways in the network. However, it is important to remember that all streets in a city should safely and comfortably accommodate bicyclists, regardless of whether the street is designated as a bikeway. Several general types of bikeways are listed below with no implied order of preference. In California, local jurisdictions should follow minimum width and geometric criteria in the Highway Design Manual Chapter 1000, or



*Bicycle route
(Credit: Marty Bruinsma)*

follow proper procedures for exemptions and experiments. It should be noted that Chapter 1000 contains minimums. Many jurisdictions read this to mean exact dimension. In many circumstances, exceeding these minimums provides for a more desirable bicycling environment.

Shared Roadways

A shared roadway is a street in which bicyclists ride in the same travel lanes as other traffic. There are no specific dimensions for shared roadways. On narrow travel lanes, motorists have to cross over into the adjacent travel lane to pass a cyclist. Shared roadways work well and are common on low-volume, low-speed neighborhood residential streets, rural roads, and even many low-volume highways. In California shared roadways are known as Class III bikeways.

Bicycle Boulevards

A bicycle boulevard is a street that has been modified to prioritize through bicycle traffic but discourage through motor vehicle traffic. Traffic calming devices control traffic speeds and discourage through trips by automobiles. Traffic controls limit conflicts between automobiles and bicyclists and give priority to through bicycle movement at intersections.



*Bicycle boulevard: Portland, OR
(Credit: Ryan Snyder)*



*Bicyclist using bike lane
(Credit: Dan Burden)*



*Bike Lane
(Credit: Marty Bruinsma)*



*Shared-use path
(Credit: Marty Bruinsma)*

Shoulder Bikeways

This facility accommodates bicycle travel on rural highways and country roads by providing a suitable area for bicycling and reducing conflicts with faster moving motor vehicles.

Bike Lanes

Portions of the traveled way designated with striping, stencils, and signs for preferential use by bicyclists, bike lanes are appropriate on avenues and boulevards. They may be used on other streets where bicycle travel and demand is substantial. Where on-street parking is provided, bike lanes are striped on the left side of the parking lane. In California bike lanes are designated as Class II bikeways.

Cycle Tracks

Cycle tracks are specially designed bikeways separated from the parallel motor vehicle travelway by a line of parked cars, landscaping, or a physical barrier that motor vehicles cannot cross. Cycle tracks are effective in attracting users who are concerned about conflicts with motorized traffic.

Shared Use Paths

Shared use paths are facilities separated from motor vehicle traffic by an open space or barrier, either within the highway right-of-way or within an independent right-of-way. Bicyclists, pedestrians, joggers, and skaters often use these paths. Shared-use paths are appropriate in areas not well served by the street system, such as in long, relatively uninterrupted corridors like waterways, utility corridors, and rail lines. They are often elements of a community trail plan. Shared use paths may also be integrated into the street network with new subdivisions as described in Chapter 3, "Street Networks and Classifications." In California shared-use paths are designated as Class I bikeways.



*Example of a shared-use path:
Burbank, CA (Credit: Ryan Snyder)*

Bike Routes

A term used for planning purposes or to designate recommended bicycle touring routes, a bike route can be any bikeway type.

INTEGRATING WITH THE STREET SYSTEM

Most bikeways are part of the street; therefore, well-connected street systems are very conducive to bicycling, especially those with a fine-meshed network of low-volume, low-speed streets suitable for shared roadways. In less well-connected street systems, where wide streets carry the bulk of traffic, bicyclists need supplementary facilities, such as short sections of paths and bridges, to connect otherwise unconnected streets.

There are no hard and fast rules for when a specific type of bikeway should be used, but some general principles guide selection. As a general rule, as traffic volumes and speeds increase, greater separation from motor vehicle traffic is desirable. Other factors to consider are users (more children or recreational cyclists may warrant greater separation), adjacent land uses (multiple driveways may cause conflicts with shared-use paths), available right-of-way (separated facilities require greater width), and costs.

As a general rule, designated bicycle facilities (e.g., bike lanes and cycle tracks) should be provided on all major streets (avenues and boulevards), as these roads generally offer the greatest level of

directness and connectivity in the network, and are typically where destinations are located. There are occasions when it is infeasible or impractical to provide bikeways on a busy street, or the street does not serve the mobility and access needs of bicyclists. The following guidelines should be used to determine if it is more appropriate to provide facilities on a parallel local street:

- Conditions exist such that it is not economically or environmentally feasible to provide adequate bicycle facilities on the street.
- The street does not provide adequate access to destination points within reasonable walking distances, or separated bikeways on the street would not be considered safe.
- The parallel route provides continuity and convenient access to destinations served by the street.
- Costs to improve the parallel route are no greater than costs to improve the street.
- If any of these factors are met, cyclists may actually prefer the parallel local street facility in that it may offer a higher level of comfort (bicycle boulevards are based on this approach).

Off-street paths can also be used to provide transportation in corridors otherwise not served by the street system, such as along rivers and canals, through parks, along utility corridors, on abandoned railroad tracks, or along active railroad rights-of-way. While paths offer the safety and scenic advantages of separation from traffic, they must also offer frequent connections to the street system and to destinations such as residential areas, employment sites, shopping, and schools. Street crossings must be well designed with measures such as signals or median refuge islands.

DESIGN OF EACH BIKEWAY TYPE

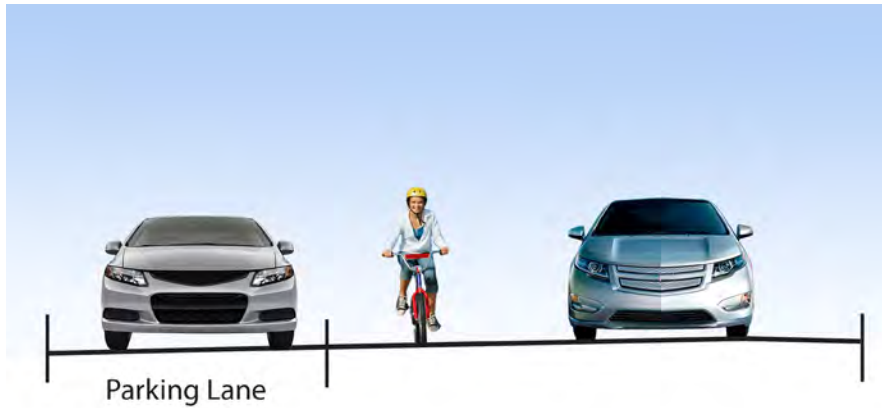

Shared roadway (Credit: Michele Weisbart)

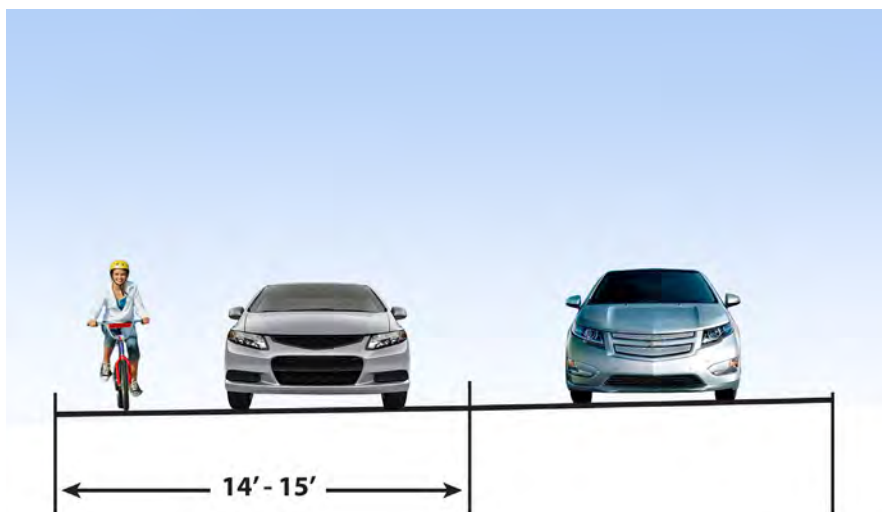

Wide curb lane (Credit: Michele Weisbart)

The following sections provide design guidance for each type of bikeway.

Shared Roadways

Shared roadways are the most common bikeway type. There are no specific width standards for shared roadways. Most are fairly narrow; they are simply the streets as constructed. Shared roadways are suitable on streets with low motor vehicle speeds or traffic volumes, and on low-volume rural roads and highways. The suitability of a shared roadway decreases as motor vehicle traffic speeds and volumes increase, especially on rural roads with poor sight distance.

Many local streets carry excessive traffic volumes at speeds higher than they were designed to carry. These can function better as shared roadways if traffic speeds and volumes are reduced. For a local street to function acceptably as a shared roadway, traffic volumes should not be more than 3,000 to 5,000 vehicles per day, and speeds should be 25 mph or less. If traffic speeds and volumes exceed those thresholds, separated facilities (e.g., bike lanes) should be considered or traffic calming should be applied to reduce the vehicle speeds/volumes. Many traffic-calming techniques can make these streets more amenable to bicycling.

Wide Curb Lanes

On streets where bike lanes would be more appropriate but with insufficient width for bike lanes, wide curb lanes may be provided. This may occur on retrofit projects where there are physical constraints and all other options, such as narrowing travel lanes, have been pursued. Wide curb lanes are not particularly attractive to most cyclists; they simply allow a passenger vehicle to pass cyclists within a travel lane, if cyclists are riding far enough to the right. Wide curb lanes may also encourage higher motor vehicle speeds, which is contrary to the design principles of this manual; wide lanes should never be used on local residential streets. A 14 to 15-foot wide lane allows a passenger car to pass a cyclist in the same lane. Widths 16 feet or greater encourage the undesirable operation of two motor vehicles in one lane. In this situation, a bike lane should be striped.

Sharrows

Shared-lane marking stencils (“SLMs,” also commonly called “sharrows”) may be used as an additional treatment for shared roadways. The stencils can serve a number of purposes: they remind bicyclists to ride further from parked cars to prevent “dooring” collisions, they make motorists aware of bicycles potentially in the travel lane, and they show bicyclists the correct direction of travel. Sharrows installed next to parallel parking should be a minimum distance of 11 feet from the curb. Installing farther than 11 feet from the curb may be desired in areas with wider parking lanes or in situations where the sharrow is best situated in the center of the shared travel lane to promote cyclists taking the lane. Placing the sharrow between vehicle tire tracks increases the life of the markings and decreases long-term maintenance costs.

Centerline Removal

On streets with one travel lane in each direction, removal of the centerline is recommended to facilitate passing of bicyclists by motor vehicles. Motorists may be unwilling to cross over a centerline to pass a cyclist, resulting in instances where motorists feel like they are stuck behind a slower moving cyclist and attempt to pass the cyclist too closely. Cyclists in these situations may feel pressured to ride to the extreme far right or in the gutter to allow motorists to pass. Removal of the centerline opens the entire traveled way for passing, and allows bicyclists to position themselves at a safe and comfortable distance

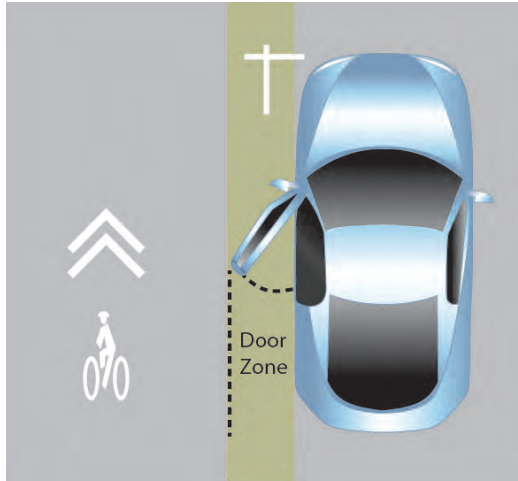

Sharrows (Credit: Michele Weisbart)



Example of a sharrow: Los Angeles, CA (Credit: Ryan Snyder)

from the curb. Lack of centerlines is also a traffic-calming technique, as drivers tend to drive slower without the visible separation from oncoming traffic. The MUTCD mandates centerline stripes on urban streets with ADT of 6,000 or more; most neighborhood streets suitable for sharing are well below that threshold

Bicycle Boulevards

A bicycle boulevard is an enhanced shared roadway; a local street is modified to function as a prioritized through street for bicyclists while maintaining local access for automobiles. This is done by adding traffic-calming devices to reduce motor vehicle speeds and through trips, and installing traffic controls that limit conflicts between motorists and bicyclists and give priority to through bicyclist movement. One key advantage of bicycle boulevards is that they attract cyclists who do not feel comfortable on busy streets and prefer to ride on lower traffic streets. Bicycle travel on local streets is generally compatible with local land uses (e.g., residential and some retail). Residents who want slower traffic on neighborhood streets often like measures that support bicycle boulevards. By reducing traffic and improving crossings, bicycle boulevards also improve conditions for pedestrians. Successful bicycle boulevard implementation requires careful planning with residents and businesses to ensure acceptance.

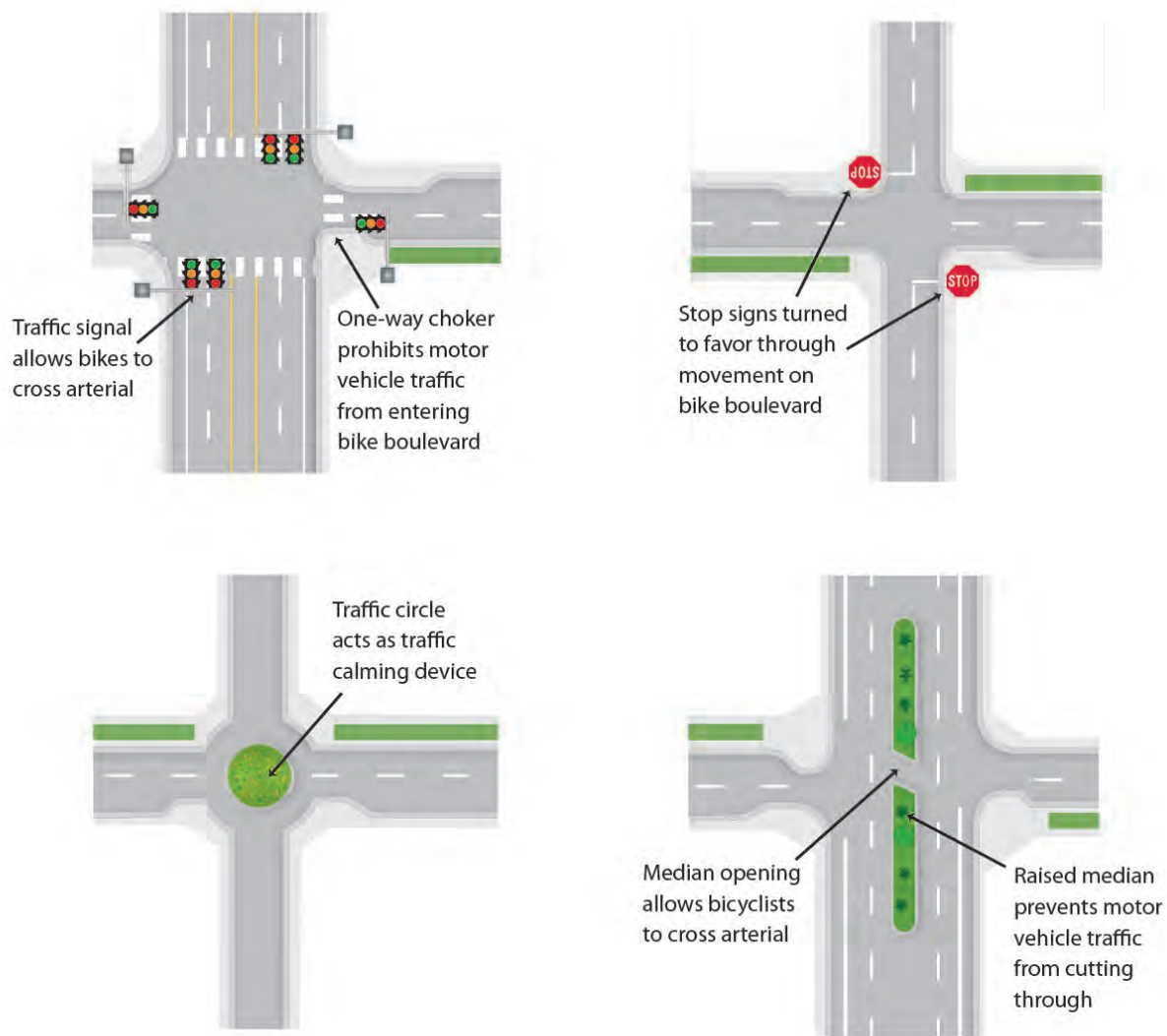

Components of bike boulevards (Credit: Michele Weisbart)

Elements of a Bicycle Boulevard

A successful bike boulevard includes the following design elements:

- Selecting a direct and continuous street, rather than a circuitous route that winds through neighborhoods. Bike boulevards work best on a street grid. If any traffic diversion will likely result from the bike boulevard, selecting streets that have parallel higher-level streets can prevent unpopular diversion to other residential streets.
- Placing motor vehicle traffic diverters at key intersections to reduce through motor vehicle traffic (diverters are designed to allow through bicyclist movement)

- Turning stop signs towards intersecting streets, so bicyclists can ride with few interruptions
- Replacing stop-controlled intersections with mini-circles and mini-roundabouts to reduce the number of stops cyclists have to make
- Placing traffic-calming devices to lower motor vehicle traffic speeds
- Placing wayfinding and other signs or markings to route cyclists to key destinations, to guide cyclists through difficult situations, and to alert motorists of the presence of bicyclists
- Where the bike boulevard crosses high-speed or high-volume streets, providing crossing improvements such as
 - Signals, where a traffic study has shown that a signal will be safe and effective. To ensure that bicyclists can activate the signal, loop detection should be installed in the pavement where bicyclists ride.
 - Roundabouts where appropriate.
 - Median refuges wide enough to provide a refuge (8 feet minimum) and with an opening wide enough to allow bicyclists to pass through (6 feet). The design should allow bicyclists to see the travel lanes they must cross.



Traffic circles allow for landscaping opportunities (Credit: Ryan Snyder)

Shoulder Bikeways

Paved shoulders are provided on rural highways for a variety of safety, operational, and maintenance reasons; they also provide a place for bicyclists to ride at their own pace, out of the stream of motorized traffic.

When providing shoulders for bicycle use, a minimum width of 6 feet is recommended. This allows a cyclist to ride far enough from the edge of pavement to avoid debris and far enough from passing vehicles to avoid conflicts. On roads with prevailing speeds over 45 mph, 8 feet is preferred. If there are physical width limitations, a minimum 4-foot shoulder may be used.

Bike Lanes

Bike lanes are a portion of the traveled way designated for preferential use by bicyclists; they are most suitable on avenues and boulevards. Bike lanes may also be provided on rural roads where there is high bicycle use. Bike lanes are generally not recommended on local streets with relatively low traffic volumes and speeds, where a shared roadway is the appropriate facility. There are no hard and fast mandates for providing bike lanes, but as a general rule, most jurisdictions consider bike lanes on roads with traffic volumes in excess of 3,000-5,000 ADT or traffic speeds of 30 mph or greater.

Bike lanes have the following advantages:

- They enable cyclists to ride at a constant speed, especially when traffic in the adjacent travel lanes speeds up or slows down (stop-and-go).
- They enable bicyclists to position themselves where they will be visible to motorists.
- They encourage cyclists to ride on the traveled way rather than the sidewalk.

Bike lanes are created with a solid stripe and stencils. Motorists are prohibited from using bike lanes for driving and parking, but may use them for emergency avoidance maneuvers or breakdowns. Bike lanes are one-way facilities that carry bicycle traffic in the same direction as adjacent motor-vehicle traffic. Bike lanes should always be provided on both sides of a two-way street. One exception is on hills where topographical constraints limit the width to a bike lane on one side only; the bike lane should be provided in the uphill direction as cyclists ride slower uphill, and they can ride in a shared lane in the downhill direction.

The minimum bike lane width is 5 feet from the face of a curb, or 4 feet on open shoulders. If on-street parking is permitted, the bike lane should be placed between parking and the travel lane with a preferred width of 6 feet so cyclists can ride outside the door zone. Streets with high volumes of traffic and/or higher speeds need wider bike lanes (6 feet to 8 feet) than those with less traffic or slow speeds. On curbed sections, a 4-foot (minimum 3 feet) wide smooth surface should be provided between the gutter pan and stripe. This minimum width enables cyclists to ride far enough from the curb to avoid debris and drainage grates and far enough from other vehicles to avoid conflicts.

By riding away from the curb, cyclists are more visible to motorists than when hugging the curb. Where on-street parking is permitted, delineating the bike lane with two stripes, one on the street side and one on the parking side, is preferable to a single stripe.

Bike Lanes on Two-Way Streets

Basic bike lanes on two-way streets comprise the majority of bike lanes. They should follow the design guidelines for width with and without on-street parking.

Bike Lanes on One-Way Streets

Bike lanes on one-way streets should generally be on the right side of the traveled way and should always be provided on both legs of a one-way couplet. The bike lane may be placed on the left of a one-way street if it decreases the number of conflicts (e.g., those caused by heavy bus traffic or parking) and if cyclists can safely and conveniently transition in and out of the bike lane. If sufficient width exists, the bike lanes can be striped on both sides.

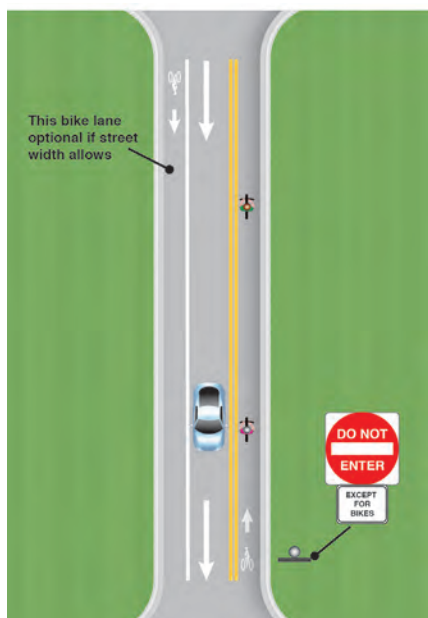

*Contra-flow bike lane design
(Credit: Michele Weisbart)*

Contra-Flow Bike Lanes

Contra-flow bike lanes are provided to allow bicyclists to ride in the opposite direction of motor vehicle traffic. They convert a one-way traffic street into a two-way street: one direction for motor vehicles and bikes and the other for bikes only. Contra-flow lanes are separated with yellow center lane striping. Combining both directions of bicycle travel on one side of the street to accommodate contra-flow movement results in a two-way cycle track.

Contra-flow bike lanes are useful where they provide a substantial savings in out-of-direction travel with direct access to high-use destinations, and safety is improved because of reduced conflicts compared to the longer route. The contra-flow design introduces new design challenges and may create additional conflict points as motorists may not expect on-coming bicyclists.

Bike Lanes and Bus Lanes

In most instances, bicycles and buses can share the available road space. On routes heavily traveled by both bicyclists and buses, separation can reduce conflicts (stopped buses hinder bicycle movement and slower moving bicycles hinder buses). Ideally, shared bicycle/bus lanes should be 13 feet to 15 feet wide to allow passing by both buses and bicyclists.

Separate bus lanes and bike lanes should be considered to reduce conflicts between passengers and bicyclists, with the bus lane at the curbside. Buses will be passing bicyclists on the right, but the fewer merging and turning movements reduce overall conflicts.

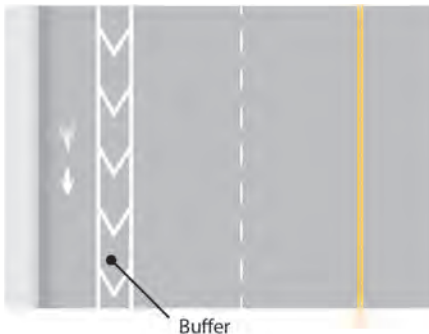

Painted-buffer bike lanes
(Credit: Michele Weisbart)

Buffered Bike Lanes

Buffered bike lanes provide a painted divider between the bike lane and the travel lanes. This additional space can improve the comfort of cyclists as they don't have to ride as close to motor vehicles. Buffered bike lanes can also be used to slow traffic as they narrow the travel lanes. An additional buffer may be used between parked cars and bike lanes to direct cyclists to ride outside of the door zone of the parked cars. Buffered bike lanes are most appropriate on wide, busy streets. They can be used on streets where physically separating the bike lanes with cycle tracks is undesirable for cost, operational, or maintenance reasons.

Raised Bike Lanes

Bike lanes are typically an integral portion of the traveled way and are delineated from motor vehicle lanes with painted stripes. Though most bicyclists ride on these facilities comfortably, others prefer more separation. Raised bike lanes incorporate the convenience of riding on the street with some physical separation. This is done by elevating the bicycle lane surface 2 to 4 inches above street level, while providing a traversable curb to separate the bikeway from the motor vehicle travelway. This treatment offers the following advantages:

- Motorists know they are straying from the travel way when they feel the slight bump created by the curb.
- The mountable curb allows motorists to make turns into and out of driveways.

- The mountable curb allows cyclists to enter or leave the bike lane (e.g., for turning left or overtaking another cyclist).
- The raised bike lane drains towards the centerline, leaving it clear of debris and puddles.
- Novice bicyclists are more likely to ride in the bike lane, leaving the sidewalk for pedestrians.

Raised bike lanes can be constructed at little additional expense for new roads. Retrofitting streets with raised bike lanes is more costly; it is best to integrate raised bike lanes into a larger project to remodel the street due to drainage replacement. Special maintenance procedures may be needed to keep raised bike lanes swept.

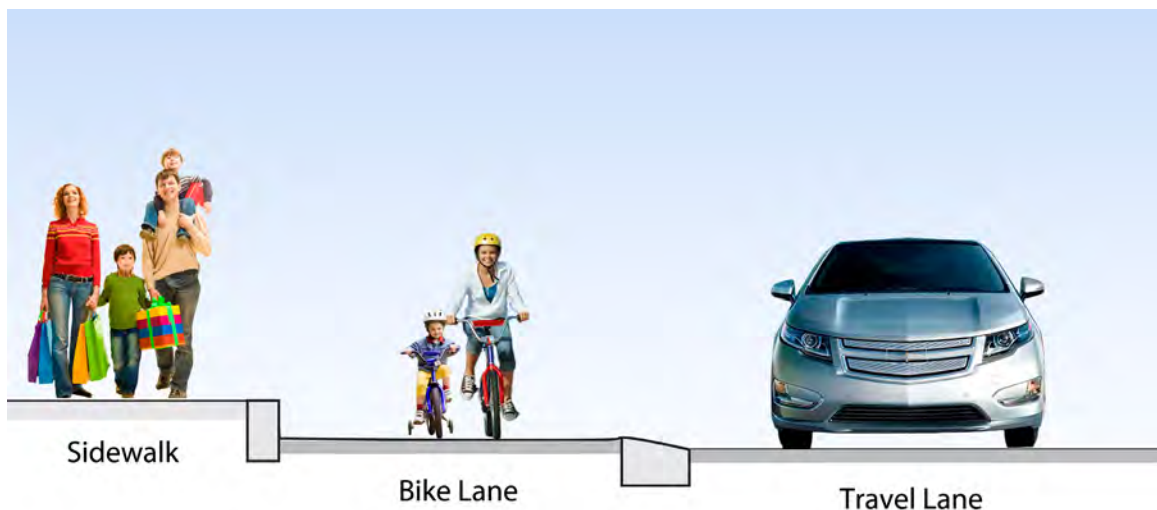

Raised bike lanes (Credit: Michele Weisbart)

Cycle Tracks

Cycle tracks, also known as protected bike lanes, are bikeways located on or adjacent to streets where bicycle traffic is separated from motor vehicle traffic by physical barriers, such as on-street parking, posts/bollards, and landscaped islands. They can be well suited to downtown areas where they minimize traffic conflicts with pedestrians. Streets selected for cycle tracks should have minimal pedestrian crossings and driveways. They should also have minimal loading/unloading activity and other street activity. The cycle tracks should be designed to minimize conflicts with these activities as well as with pedestrians and driveways.

Cycle tracks can be provided on new facilities, but they require more width than other types of bikeways. They are best suited for existing streets where surplus width is available; the combined width of the cycle track and the barrier is more or less the width of a travel lane. The area to be used by bicycles should be designed with adequate width for street sweeping to ensure that debris will not accumulate. Cycle tracks tend to work most effectively where there are few uncontrolled crossing points with unexpected traffic conflicts. Cycle track concerns include treatment at intersections, uncontrolled midblock driveways and crossings, wrong-way bicycle traffic, and difficulty accessing or exiting the facility at midblock locations. There is some controversy regarding the comparative safety of cycle tracks. Recent studies have concluded that cycle tracks are as safe as other treatments when high usage is expected and when measures such as separate signal phases for right-turning motor vehicle and through cyclists, and left-turning cyclists and through motor vehicles, are deployed to regulate crossing traffic.



Cycle track (Credit: Dan Burden)

Shared Use Paths

Shared use paths should be a minimum of 8 feet wide with 2 feet of graded shoulder on each side. This width is suitable in rural or small-town settings. Generally, 12 feet of paved path is preferred. Wider pavement may be needed in high-use areas. Where significant numbers of pedestrians, bicyclists, skaters, and other users use the

paths, either wider pavement or separate walkways help to eliminate conflicts. Most important in designing shared use paths is good design of intersections where they cross streets. These crossings should be treated as intersections with appropriate treatment.

INTERSECTIONS

Intersections are junctions at which different modes of transportation meet and facilities overlap. A well-designed intersection facilitates the interchange between bicyclists, pedestrians, motorists, and transit so traffic flows in a safe and efficient manner. Designs for intersections with bicycle facilities should reduce conflicts between bicyclists (and other vulnerable road users) and vehicles by heightening visibility, denoting a clear right of way, and ensuring that the various users are aware of each other. Intersection treatments can resolve both queuing and merging maneuvers for bicyclists, and are often coordinated with timed or specialized signals.

Chapter 5, “Intersection Design,” provides general principles of geometric design; all these recommendations will benefit cyclists. The configuration of a safe intersection for bicyclists may include additional elements such as color, signs, medians, signal detection, and pavement markings. Intersection design should take into consideration existing and anticipated bicyclist, pedestrian, and motorist movements. In all cases, the degree of mixing or separation between bicyclists and other modes is intended to reduce the risk of crashes and increase bicyclist comfort. The level of treatment required for bicyclists at an intersection will depend on the bicycle facility type used, whether bicycle facilities are intersecting, the adjacent street function, and the adjacent land use.

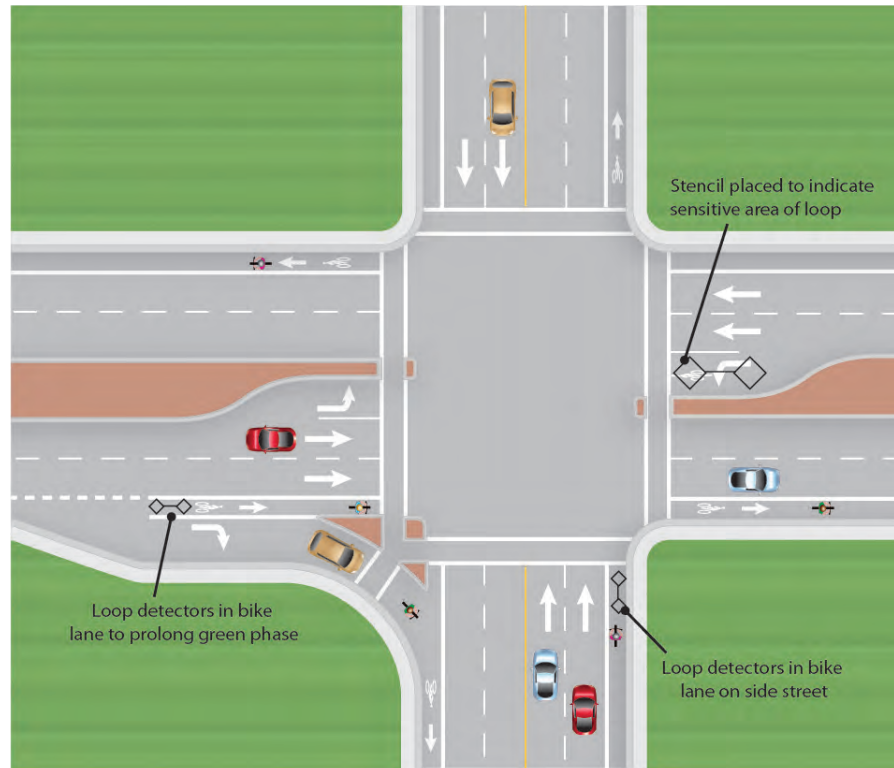

*Bikeway markings at intersections
(Credit: Michele Weisbart)*

Bikeway Markings at Intersections

Continuing marked bicycle facilities at intersections (up to the crosswalk) ensures that separation, guidance on proper positioning, and awareness by motorists are maintained through these potential conflict areas. The appropriate treatment for right-turn only lanes is to place a bike lane pocket between the right-turn lane and the rightmost through lane. If a full bike lane pocket cannot be accommodated, a shared bicycle/right turn lane can be installed that places a standard-width bike lane on the left side of a dedicated right-turn lane. A dashed strip delineates the space for bicyclists and motorists within the shared lane. This treatment includes signs advising motorists and bicyclists of proper positioning within the lane. Sharrows are another option for marking a bikeway through an intersection where a bike lane pocket cannot be accommodated.

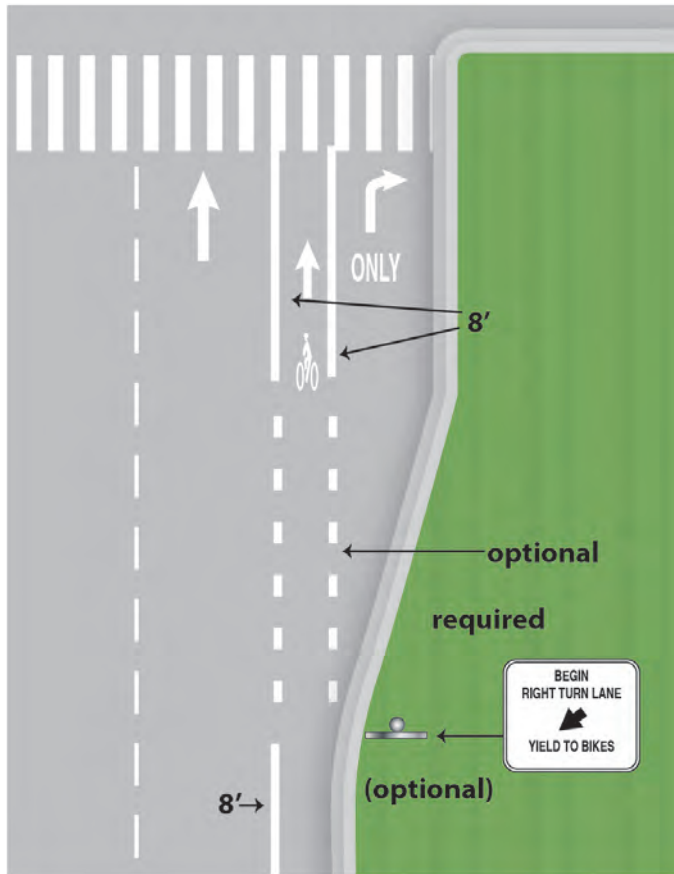

Bike lane markings at intersections with right-turn lanes
(Credit: Michele Weisbart)



Bicycle signal head: Long Beach, CA
(Credit: Charlie Gandy)

Bike Signal Heads

Bicycle signal heads may be installed at signalized intersections to improve identified safety or operational problems for bicyclists; they provide guidance for bicyclists at intersections where bicyclists may have different needs from other road users (e.g., bicycle-only movements and leading bicycle intervals) or to indicate separate bicycle signal phases and other bicycle-specific timing strategies. A bicycle signal should only be used in combination with an existing conventional or hybrid beacon. In the United States, bicycle signal heads typically use standard three-lens signal heads in green, yellow, and red with a stencil of a bicycle.

Bicycle Signal Detection

Bicycle detection is used at actuated traffic signals to alert the signal controller of bicycle crossing demand on a particular approach. Bicycle detection occurs either through the use of push buttons or by automated means (e.g., in-pavement loops, video, and microwave). Inductive loop vehicle detection at many signalized intersections is calibrated to the size or metallic mass of a vehicle, meaning that bicycles may often go undetected. The result is that bicyclists must either wait for a vehicle to arrive, dismount, and push the pedestrian button (if available), or cross illegally. Loop sensitivity can be increased to detect bicycles.

Proper bicycle detection must accurately detect bicyclists (be sensitive to the mass and volume of a bicycle and its rider); and provide clear guidance to bicyclists on how to actuate detection (e.g., what button to push or where to stand). California law requires that newly constructed actuated traffic signals and newly installed detector systems be designed to detect bicycles.



*Bicycle box: Portland, OR
(Credit: Ryan Snyder)*

Bike Boxes

A bike box is a designated area at the head of a traffic lane at a signalized intersection that provides bicyclists with a safe and visible way to get ahead of queuing traffic during the red signal phase. Appropriate locations include:

- At signalized intersections with high volumes of bicycles and/or motor vehicles, especially those with frequent bicyclist left-turns and/or motorist right-turns
- Where there may be right or left-turning conflicts between bicyclists and motorists
- Where there is a desire to better accommodate left-turning bicycle traffic
- Where a left turn is required to follow a designated bike route or boulevard or access a shared-use path, or when the bicycle lane moves to the left side of the street
- When the dominant motor vehicle traffic flows right and bicycle traffic continues through (such as at a Y intersection or access ramp)

Bicycle Countdowns

Near-side bicycle signals may incorporate a “countdown to green” display to provide information about how long until the green bicycle indication is shown, enabling riders to push off as soon as the light turns green.

Leading Bicycle Intervals

Based on the Leading Pedestrian Interval, a Leading Bicycle Interval (LBI) can be implemented in conjunction with a bicycle signal head. Under an LBI, bicyclists are given a green signal while the vehicular traffic is held at all red for several seconds, providing a head start for bicyclists to advance through the intersection. This treatment is particularly effective in locations where bicyclists are required to make a challenging merge or lane change (e.g., to access a left turn pocket) shortly after the intersection, as the LBI would give them sufficient time to make the merge before being overtaken by vehicular traffic. This treatment can be used to enhance a bicycle box.

Two-Stage Turn Queue Boxes

On right side cycle tracks, bicyclists are often unable to merge into traffic to turn left due to physical separation. This makes the provision of two-stage left turns critical in ensuring these facilities are functional. The same principles for two-stage turns apply to both bike lanes and cycle tracks. While two-stage turns may increase bicyclist comfort in many locations, this configuration will typically result in higher average signal delay for bicyclists due to the need to receive two separate green signal indications (one for the through street, followed by one for the cross street) before proceeding.



Colored bicycle lanes (Credit: Michele Weisbart)



Green-colored bicycle lanes: San Francisco, CA (Credit: San Francisco Municipal Transportation Agency)

Colored Pavement Treatments

Pavement coloring is useful for a variety of applications in conjunction with bicycle facilities. The primary goal of colored pavements is to differentiate specific portions of the traveled way, but colored pavements can also visibly reduce the perceived width of the street.

Colored pavements are used to highlight conflict areas between bicycle lanes and turn lanes, especially where bicycle lanes merge across motor vehicle turn lanes. Colored pavements can be used in conjunction with sharrows (shared lane markings) in heavily used commercial corridors where no other provisions for bicycle facilities are evident.

While a variety of colored treatments have been used, the trend is for spring green as the preferred color for bicycle facilities of this type, especially in areas where conflicts or shared use is intended. Maintenance of color and surface condition are considerations. Traditional traffic paints and coatings can become slippery. Long life surfaces with good wet skid resistance should be considered.



Wayfinding signs: Seattle, WA
(Credit: Ryan Snyder)

Wayfinding

The ability to navigate through a region is informed by landmarks, natural features, signs, and other visual cues. Wayfinding is a cost-effective and highly visible way to improve the bicycling environment by familiarizing users with the bicycle network, helping users identify the best routes to destinations, addressing misperceptions about time and distance, and helping overcome a barrier to entry for infrequent cyclists (e.g., “interested but concerned” cyclists).

A bikeway wayfinding system is typically composed of signs indicating direction of travel, location of destinations, and travel time/distance to those destinations; pavement markings indicating to bicyclists that they are on a designated route or bike boulevard and reminding motorists to drive courteously; and maps providing users with information regarding destinations, bicycle facilities, and route options.

Legal Status

As of the writing of this manual, a number of the designs discussed above, including cycle tracks, buffered bike lanes next to on-street parking, conflict zone colored bike lanes, bike boxes, and colored treatments of travel lanes with sharrow, have not yet been recognized by the Federal MUTCD, AASHTO, or the California MUTCD and are considered experimental treatments. These devices appear to be promising improvements in bicycle access and safety as they have been widely used in Europe and experimented with in the U.S. Any jurisdiction wishing to use these treatments should follow the appropriate experimental procedures.



Inverted U Bike Rack (Credit: Sky Yim)

Bicycle Parking

Secure bicycle parking at likely destinations is an integral part of a bikeway network. Bicycle thefts are common and lack of secure parking is often cited as a reason people hesitate to ride a bicycle. The same consideration should be given to bicyclists as to motorists, who expect convenient and secure parking at all destinations. Bicycle parking should be located in well-lit, secure locations close to the main entrance of a building, no further from the entrance than the closest automobile parking space. Bike parking should not interfere with pedestrian movement.



Bicycle racks can double as public art: Los Angeles, CA (Credit: Sky Yim)

Bike racks along sidewalks should support the bicycle well, and make it easy to lock a U-shaped lock to the frame of the bike and the rack. The two samples below show an “inverted –U” rack and an art design rack: both meet these criteria. Refer to the APBP Bike Parking Guidelines for additional information.

Maintenance

Maintenance is a critical part of safe and comfortable bicycle access. Two areas that are of particular importance to bicyclists are pavement quality and drainage grates. Rough surfaces, potholes, and imperfections, such as joints, can cause a rider to lose control and fall. Care must be taken to ensure that drainage grates are bicycle-safe; otherwise a bicycle wheel may fall into the slots of the grate, causing the cyclist to fall. The grate and inlet box must be flush with the adjacent surface. Inlets should be raised after a pavement overlay to the new surface. If this is not possible or practical, the new pavement should taper into drainage inlets so the inlet edge is not abrupt.

The most effective way to avoid drainage-grate problems is to eliminate them entirely with the use of inlets in the curb face. This may require more grates to handle bypass flow, but is the most bicycle-friendly design.

IMPLEMENTATION

Implementation of a bikeway network often requires an implementation plan. Some bikeways, such as paths, bicycle boulevards, and other innovative techniques described in this guide, will require a capital improvement project process, including identifying funding, a public and environmental review process, and plan preparation. Other bikeway improvements piggy-back onto planned construction, such as resurfacing, reconstruction, or utility work.

The majority of bikeway facilities are provided on streets in the form of shared roadways or bicycle lanes. Shared roadways usually require virtually no change to existing roadways, except for some directional signs, occasional markings, and minor changes in traffic control devices; removing unnecessary centerline stripes is a strategy that can be implemented after resurfacing projects. Striped bike lanes are implemented on existing roads through use of the strategies below.



Fitting in bicycle lanes with road diets (Credit: Michele Weisbart)

Resurfacing

The cost of striping bicycle lanes is negligible when incorporated with resurfacing, as this avoids the high cost of stripe removal; the fresh pavement provides a blank slate. Jurisdictions will need to anticipate opportunities and synchronize restriping plans with repaving and reconstruction plans. If new pavement is not anticipated in the near future, grinding out the old lane lines can still provide bike lanes.

There are three basic techniques for finding room for bike lanes:

- **Lane narrowing.** Where all existing or planned travel lanes must be retained, travel lanes can be narrowed to provide space for bike lanes. Recent studies have indicated that the use of 10-foot travel lanes does not result in decreased safety in comparison with wider lanes for vehicle speeds up to 35 mph. Eleven-foot lanes can be used satisfactorily at higher speeds especially where trucks and buses frequently run on these streets. However, where a choice between a 6-foot bike lane and an 11-foot travel lane must be made, it is usually preferable to have the 6-foot bike lane. Parking lanes can also be narrowed to 7 feet to create space for bike lanes.
- **Road diets.** Reducing the number of travel lanes provides space for bicycle lanes. Many streets have more space for vehicular traffic than necessary. Some streets may require a traffic and/or environmental analysis to determine whether additional needs or impacts may be anticipated. The traditional road diet changes a four-lane undivided street to two travel lanes, a

continuous left-turn lane (or median), and bike lanes. In other cases, a four-lane street can be reduced to a two-lane street without a center-turn lane if there are few left turns movements. One-way couplets are good lane-reduction candidates if they have more travel lanes in one direction than necessary for the traffic volumes. For example, a four-lane one-way street can be reduced to three lanes and a bike lane. Since only one bike lane is needed on a one-way street, removing a travel lane can free enough room for other features, such as on-street parking or wider sidewalks. Both legs of a couplet must be treated equally, so there is a bike lane in each direction.

- **Parking Removal.** On-street parking is vital on certain streets (such as residential or traditional central business districts with little or no off-street parking), but other streets have allowable parking without a significant visible demand. In these cases, parking prohibition can be used to provide bike lanes with minimal public inconvenience.

Utility Work

Utility work often requires reconstructing the street surface to complete restoration work. This provides opportunities to implement bike lanes and more complex bikeways such as bike boulevards, cycle tracks, or paths. It is necessary to provide plans for proper implementation and design of bikeway facilities prior to the utility work. It is equally necessary to ensure that existing bikeways are replaced where they exist prior to utility construction.

Redevelopment

When streets are slated for reconstruction in conjunction with redevelopment, opportunities exist to integrate bicycle lanes or other facilities into the redevelopment plans.

Paved Shoulders

Adding paved shoulders to existing roads can be quite expensive if done as stand-alone, capital improvement projects, especially if ditch lines have to be moved, or if open drains are changed to enclosed drains. But paved shoulders can be added at little extra cost if they are incorporated into projects that already disturb the area beyond the pavement, such as laying utility lines or drainage work.

ADDITIONAL RESOURCES

National Association of City Transportation Officials, *Urban Bikeway Design Guide*, 2011

Caltrans, *Complete Intersections: A Guide to Restructuring Intersections and Interchanges for Bicyclists and Pedestrians*, 2010

California *Highway Design Manual* Chapter 1000

AASHTO *Guide for the Development of Bicycle Facilities*

Chapter 9. TRANSIT ACCOMODATIONS

INTRODUCTION.....	9-2
ESSENTIAL PRINCIPLES OF DESIGNING STREETS FOR TRANSIT.....	9-2
ACCESS TO TRANSIT.....	9-4
BUS STOPS.....	9-4
Layout.....	9-4
Transit-Specific Streetscape Elements.....	9-5
BUS STOP PLACEMENT.....	9-7
SIGNAL TREATMENT.....	9-9
BUS BULBS.....	9-10
Characteristics.....	9-11
URBAN DESIGN.....	9-12
BICYCLE CONNECTIONS.....	9-13
BUS LANES.....	9-13
ACCOMODATING LIGHT RAIL, STREET CARS, AND BRT.....	9-14



INTRODUCTION

Public transit serves a vital transportation function for many people; it is their access to jobs, school, shopping, recreation, visitation, worship, and other daily functions. Except for subways and rail lines on exclusive rights-of-way, most transit uses streets. For transit to provide optimal service, streets must accommodate transit vehicles as well as access to stops. Transit connects passengers to destinations and is an integral component of shaping future growth into a more sustainable form. Transit design should also support placemaking.

This chapter provides design guidance for both transit stops and transit operating in the streets, including bus stop layout and placement and the use of bus bulbs and transit lanes. The chapter ends with a discussion of ways to accommodate light rail, street cars, and Bus Rapid Transit (BRT).

ESSENTIAL PRINCIPLES OF DESIGNING STREETS FOR TRANSIT

Public transit should be planned and designed as part of the street system. It should interface seamlessly with other modes, recognizing that successful transit depends on customers getting to the service via walking, bicycling, car, taxi, or paratransit. Transit should be planned following these principles:

- Transit has a high priority on city streets. On some streets, transit vehicles should have higher priority than private vehicles.
- The busiest transit lines should have designated bus lanes.



Bus stops should be designed for passengers (Credit: Sky Yim)



*Bus stops are centers of activity
(Credit: Ryan Snyder)*



*Examples of bus stop amenities
(Credit: Sky Yim)*

- Where ridership justifies, some streets, called transit malls, may permit only buses or trains in the travelled way. These often also allow bicycles.
- Technology should be applied to increase average speeds of transit vehicles where appropriate.
- Transit stops should be easily accessible, with safe and convenient crossing opportunities.
- Transit stops should be active and attractive public spaces that attract people on a regular basis, at various times of day, and all days of the week.
- Transit stops function as community destinations. The largest stops and stations should be designed to facilitate programming for a range of community activities and events.
- Transit stops should include amenities for passengers waiting to board.
- Transit stops should provide space for a variety of amenities in commercial areas, to serve residents, shoppers, and commuters alike.
- Transit stops should be attractive and visible from a distance.
- Transit stop placement and design influences accessibility to transit and network operations, and influences travel behavior/mode choice.
- Zoning codes, local land use ordinances, and design guidelines around transit stations should encourage walking and a mix of land uses (see Chapter 13, “Designing Land Use along Living Streets”).
- Streets that connect neighborhoods to transit facilities should be especially attractive, comfortable, and safe and inviting for pedestrians and bicyclists.

ACCESS TO TRANSIT

Transit depends primarily on walking to function well; most transit users walk to and from transit stops. Sidewalks on streets served by transit and on the streets that lead to transit corridors provide basic access. Bicycle-friendly streets do the same for those who access transit by bicycle.

Every transit trip also requires a safe and convenient street crossing at the transit stop; a disproportionately high number of pedestrian crossing crashes occur at transit stops. Every transit stop should be evaluated for its crossing opportunities. If the crossing is deemed unsafe, mitigation can occur in two ways: a crossing should be provided at the existing stop, or the stop can be moved to a location with a safer crossing. For street crossing measures, see Chapter 7, "Pedestrian Crossings." Simply stated, there should not be transit stops without means to safely and conveniently cross the street.

But simply moving a stop is not always a service to transit users who may have to walk further to access their stop. Convenient access by passengers must remain at the forefront of all transit stop planning: eliminating stops because they are perceived as unsafe will not be satisfactory to riders who cannot walk very far. But eliminating or consolidating stops can be beneficial to transit operations and users by reducing the number of times a bus, streetcar, or light rail train has to stop. The trade offs are added walking time for users but reduced transit operator delay, resulting in a shorter journey overall. For example, this might mean a two to three minute longer walk for some passengers but an eight to 10 minute shorter bus ride for all.

BUS STOPS

The following sections provide guidance for designing bus stops.

Layout

A well placed and configured transit stop offers the following characteristics:

- Clearly defines the stop as a special place
- Provides a visual cue on where to wait for a transit vehicle
- Does not block the path of travel on the adjacent sidewalk

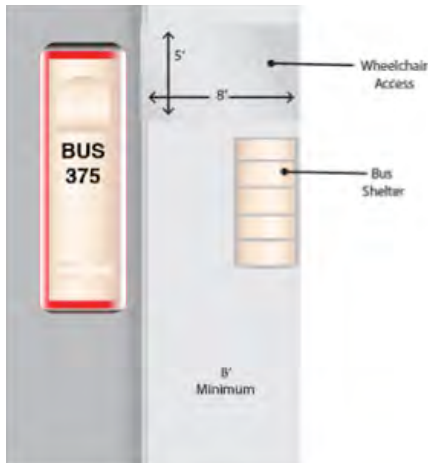

ADA compliant bus stop
(Credit: Michele Weisbart)

- Allows for ease of access between the sidewalk, the transit stop, and the transit vehicle

Layout guidelines include the following:

- Consolidate streetscape elements to create a clear waiting space and minimize obstructions between the sidewalk, waiting area, and boarding area
- Consider the use of special paving treatments or curb extensions (where there is on-street parking) to distinguish transit stops from the adjacent sidewalks
- Integrate transit stops with adjacent activity centers whenever possible to create active and safe places
- Avoid locating bus stops adjacent to driveways, curb cuts, and land uses that generate a large number of automobile trips (gas stations, drive-thru restaurants, etc.)

Transit stops are required by the Americans with Disabilities Act (ADA) to be accessible. Specifically, ADA requires a clear loading area (minimum 5 feet by 8 feet) perpendicular to the curb with a maximum 2 percent cross-slope to allow a transit vehicle to extend its lift to allow people with disabilities to board. The loading area should be located where the transit vehicle has its lift and be accessible directly from a transit shelter. The stop must also provide 30 by 40 inches of clear space within a shelter to accommodate wheelchairs. The greater use of low-floor transit vehicles may make this requirement moot; but it will still be necessary to provide enough room so wheelchair users can access all doors.



Bus stop shelter (Credit: Sky Yim)

Transit-specific Streetscape Elements

The essential streetscape elements for transit include signs, shelters, and benches.

Flag signs indicate where people are to wait and board a transit vehicle. The signs should clearly identify the transit operator, route number, and schedule. Maps showing the transit lines servicing that stop, local destinations, and additional transfer transit lines should also

be provided. Flag signs should be located towards the front of the stop

Benches should be provided at transit stops with headways longer than five minutes.

Shelters keep waiting passengers out of the rain and sun and provide increased comfort and security. Shelters vary in size and design; standard shelters are 3 to 7 feet wide and 6 to 16 feet long. They include covered seating and sign panels that can be used for transit information. Shelters should

- Be provided at transit stops with headways longer than 10 minutes
- Have electrical connections to power lighting and/or real-time transit information, or accommodate solar power
- Be set back from the front of the bus stop to allow for the bus to merge into travel lanes when the stop is located at the far side of an intersection or at a mid-block location. This setback is not required when the stop is located at the near side of the intersection or at a bus bulb.

Shelters should be located in a sidewalk's furniture zone so they don't conflict with the pedestrian zone. Shelters may be placed in the sidewalk's frontage zone provided that they do not block building entrances or the pedestrian zone.



Pre-board fare payment system: Guangzhou, China (Credit: Ryan Snyder)

Transit stops should also provide other amenities to make waiting for the next bus comfortable:

- Trash/recycling receptacles should be provided and maintained at most stops.
- Depending on headways and the number of passengers boarding and alighting, electronic “next bus” readouts can be used to inform passengers when to expect the next bus.
- Very busy bus stops and transit stations should include space for vendors to sell newspapers, magazines, flowers, and other goods to keep the stops lively.
- Rapid bus lines can include facilities that allow passengers to pay their fare before boarding the bus. Along with wide doors on buses, this allows buses to reduce their travel time by reducing dwell time at stops.

BUS STOP PLACEMENT

A bus stop’s optimal placement depends on the operational characteristics of both the roadway and the transit system. The placement of bus stops at the far side of signalized intersections is generally considered to be preferable to near side or mid-block locations. However, each location has its advantages and disadvantages, as shown in Table 9.1.

In general, bus stops should be located at the far side of a signalized intersection in order to enhance the effectiveness of traffic signal synchronization or bus signal priority projects. Near-side bus stops are appropriate for stop sign-controlled intersections. But in all cases priority should be given to the location that best serves the passengers.

Table 9.1 Bus Stop Placement Considerations

Location	Advantage	Disadvantage
Near Side	<ul style="list-style-type: none"> Minimizes interference when traffic is heavy on the far side of an intersection Provides an area for a bus to pull away from the curb and merge with traffic Minimizes the number of stops for buses Allows passengers to board and alight while the bus is stopped at a red light Allows passengers to board and alight without crossing the street if their destination is on the same side of the street. This is most important where one side of the street has an important destination, such as a school, shopping center, or employment center that generates more passenger demand than the far side. 	<ul style="list-style-type: none"> Increases conflicts with right-turning vehicles Stopped buses may obscure curb-side traffic control devices and crossing pedestrians Obscures sight distances for vehicles crossing the intersection that are stopped to the right of the buses Decreases roadway capacity during peak periods due to buses queuing in through lanes near bus stops Decreases sight distance of on-coming traffic for pedestrians crossing intersections Can delay buses that arrive during the green signal phase and finish boarding during the red phase less safe for passengers crossing in front of the bus
Far Side	<ul style="list-style-type: none"> Minimizes conflicts between right-turning vehicles and buses Optimal location for traffic signal synchronized corridors Provides additional right-turn capacity by allowing traffic to use the right lane Improves sight distance for buses approaching intersections Requires shorter deceleration distances for buses Signalized intersections create traffic gaps for buses to reenter traffic lanes Improves pedestrian safety as passengers cross in back of the bus 	<ul style="list-style-type: none"> Queuing buses may block the intersection during peak periods Sight distance may be obstructed for vehicles approaching intersections May increase the number of rear-end accidents if drivers do not expect a bus to stop after crossing an intersection Stopping both at a signalized intersection and a far-side stop may interfere with bus operations
Mid-Block	<ul style="list-style-type: none"> Minimizes sight distance problems for pedestrians and vehicles Boarding areas experience less congestion and conflicts with pedestrian travel paths Can be located adjacent to or directly across from a major transit midblock use generator 	<ul style="list-style-type: none"> Decreases on-street parking supply (unless mitigated with a curb extension) Requires a mid-block pedestrian crossing Increases walking distance to intersections Stopping buses and mid-block pedestrian crossings may disrupt mid-block traffic flow

SIGNAL TREATMENT

Signal prioritization is a component of technology-based “intelligent transportation systems” (ITS). These systems are often used by road authorities in conjunction with transit agencies to help improve a roadway system’s overall operations in the following ways:

- Reduce traffic signal delays for transit vehicles
- Improve an intersection’s person throughput
- Reduce the need for transit vehicles to stop for traffic at intersections
- Help reduce transit vehicles’ travel time
- Help improve transit system reliability and reduce waiting time for people at transit stops

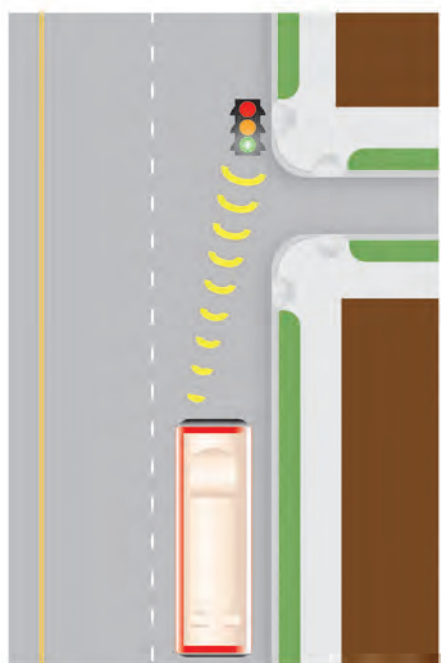

*Signal-priority technology can help to reduce delay for buses
(Credit: Michele Weisbart)*

Signal prioritization projects include signal timing or phasing projects and transit signal priority projects.

Signal timing projects optimize the traffic signals along a corridor to make better use of available green time capacity by favoring a peak directional traffic flow. These passive systems give priority to roadways with significant transit use within a district-wide traffic signal timing scheme. Transit signal prioritization can also be achieved by timing a corridor’s traffic signals based on a bus’s average operating speed instead of an automobile’s average speed.

Transit signal-priority projects alter a traffic signal’s phasing as a transit vehicle approaches an intersection. This active system requires the installation of specialized equipment at an intersection’s traffic signal controller and on the transit vehicle. It can either give an early green signal or hold a green signal that is already being displayed in order to allow buses that are operating behind schedule to get back on schedule. Signal-priority projects also help improve a transit system’s schedule adherence, operating time, and reliability.

Although they may use similar equipment, signal-priority and pre-emption are two different processes. Signal-priority modifies the normal signal operation process to better accommodate transit vehicles, while signal pre-emption interrupts the normal signal to favor transit or emergency vehicles.

The placement of a bus stop at the far side of a signalized intersection increases the effectiveness of transit signal-priority projects. Signal treatments should be used along streets with significant bus service.

BUS BULBS

Bus bulbs are curb extensions that extend the length of the transit stop on streets with on-street parking. They improve transit performance by eliminating the need for buses to merge into mixed traffic after every stop. They also facilitate passenger boarding by allowing the bus to align directly with the curb; waiting passengers can enter the bus immediately after it has stopped. They improve pedestrian conditions by providing additional space for people to wait for transit and by allowing the placement of bus shelters where they do not conflict with a sidewalk's pedestrian zone. Bus bulbs also reduce the crossing distance of a street for pedestrians if they are located at a crossing. In most situations, buses picking up passengers at bus bulbs block the curbside travel lane; but this is mitigated by the reduced dwell time, as it takes less time for the bus driver to position the bus correctly, and less time for passengers to board.

One major advantage of bus bulbs over pulling over to the curb is that they require less parking removal: typically two on-street parking spots for a bus bulb instead of four for pulling over.



Bus bulb: Alhambra, CA (Credit: Sky Yim)

The following conditions should be given priority for the placement of transit bus bulbs:

- Where transit performance is significantly slowed by the transit vehicle's merging into a mixed-flow travel lane
- Roadways served by express or Bus Rapid Transit (BRT) lines
- Stops that serve as major transfer points
- Areas with heavy transit and pedestrian activity and where narrow sidewalks do not allow for the placement of a bus shelter without conflicting with the pedestrian zone

Bus bulbs should not be considered for stops with any of the following:

- A queue-jumping lane provided for buses
- On-street parking prohibited during peak travel periods
- Near-side stops located at intersections with heavy right-turn movements, except along streets with a "transit-first" policy



*Bus bulb: Huntington Park, CA
(Credit: Sky Yim)*

Table 9.2 Standard Transit Vehicle and Transit Bus Bulb Dimensions

Vehicle	Length (feet)	Number of buses at Stop	Platform Length (feet)	
			Near Side	Far Side
Standard bus	40	1	35	45
		2	55	65
Articulated bus	60	1	80	90
		2	120	130

Characteristics

At a minimum, bus bulbs should be long enough to accommodate all doors of a transit vehicle to allow for the boarding and alighting of all passengers, or be long enough to accommodate two or more buses (with a 5-foot clearance between buses and a 10-foot clearance behind a bus) where there is frequent service such as with BRT or other express lines. Bus bulbs located on the far side of a signalized intersection should be long enough to accommodate the complete length of a bus so that the rear of the bus does not intrude into the intersection.



Bus stops should be integrated with their surroundings: Glendale, CA (Credit: Ryan Snyder)

URBAN DESIGN

Bus stops and amenities vary in complexity and design from standardized off-the-shelf signs and furniture to specially designed elements. The design of the bus stop elements, location of the bus stop in relation to adjacent land uses or activities, and the quality of the roadway's pedestrian environment contribute to a bus stop's placemaking. Transit operators like a branded look to their stops so they are easily identified, but often there is room for customized designs to fit in with the neighborhood, with at least some of the features and amenities.



Bicycle facilities at transit stations encourage intermodal travel: Los Angeles, CA (Credit: Ryan Snyder)

BICYCLE CONNECTIONS

Connecting bicycle facilities to transit stations helps extend the trip length for cyclists and reduces automobile travel. Secure bicycle parking must be provided at or within close proximity to a bus stop, preferably sheltered. At a minimum, the accommodations can be bike racks or lockers. Bike stations and automated bicycle parking can be located at areas with high levels of transit and bicycle use.

BUS LANES

Bus lanes provide exclusive or semi-exclusive use for transit vehicles to improve the transit system's travel time and operating efficiency by separating transit from congested travel lanes. They can be located in an exclusive right-of-way or share a roadway right-of-way. They can be physically separated from other travel lanes or differentiated by lane markings and signs.

Bus lanes can be located within a roadway median or along a curbside lane, and are identified by lane markings and signs. They should generally be at least 11 feet wide, but where bicycles share the lane with buses, 13 to 15 feet wide is preferred. When creating bus lanes, cities should consider the following:



*Bus-only lane: Santa Monica, CA
(Credit: Sky Yim)*

- Exclusive transit use may be limited to peak travel periods or shared with high-occupancy vehicles.
- On-street parking may be allowed depending on roadway design, especially with bus lanes located in the center of the street.
- A mixed-flow lane or on-street parking may be displaced; this is preferable to adding a lane to an already wide roadway, which increases the crossing distance for pedestrians and creates other problems discussed in other chapters.
- Within a mixed-flow lane, the roadway can be delineated by striping and signs.
- High-occupancy vehicles and/or bicycles may be permitted to use bus lanes.

Pedestrian access to stations becomes an issue when bus lanes are located in roadway medians.

ACCOMODATING LIGHT RAIL, STREET CARS, AND BRT

A growing number of streets have light rail lines, street cars, or BRT. These need to be carefully designed into the street.

The various options for accommodating light rail, street cars, and BRT within streets are as follows:

- Center-running
- Two-way split-side, with one direction of transit flow in each direction



Light-rail in urban street: Salt Lake City
(Credit: Paul Zykofsky)



Bus Rapid Transit: Bogota, Colombia
(Credit: Ryan Snyder)

- Two-way single-side, with both directions of transit flow on one side of the street right-of-way
- One-way single-side, with transit running one direction (either with or against the flow of vehicular traffic) and usually operating in a one-way couplet on parallel streets.

For each configuration, transit can operate in a reserved guideway or in mixed street traffic. When installing light rail or street cars within streets, the safety of pedestrians and bicyclists needs to be fully provided for. If poorly designed, these transit lines introduce hazards and serve to divide neighborhoods where crossings are highly limited and/or difficult or inconvenient (see Chapter 7, “Pedestrian Crossings” for more guidance). In general, in areas of high pedestrian activity, the speed of the transit service should be compatible with the speed of pedestrians.

The potential for each configuration is influenced by the street type. Some transit configurations will not work effectively in combination with certain street types. The table below outlines the compatibility of each configuration with the four street types.

Table 9.3 Street Types and Transit Configurations

	Center Running		Two-Way Split Side		Two-Way Single Side		One-Way Single Side	
Street Type	Reserved Guideway	In Street	Reserved Guideway	In Street	Reserved Guideway	In Street	Reserved Guideway	In Street
Boulevard	Y	N	N	Y	Y	N	Y*	Y
Multi-way Boulevard	Y	N*	Y	Y	N	N	Y*	Y
Avenue	Y	Y	Y*	Y	Y*	N	Y	Y
Street	N	Y	Y	Y	N*	N	Y	Y

Notes

Y = Recommended street type/transit configuration combination

N = Not recommended/possible street type/transit configuration combination

*Denotes configurations that may be possible under certain circumstances, but are not usually optimal

Source: Integration of Transit into Urban Thoroughfare Design, DRAFT White Paper prepared by the Center for Transit-Oriented Development, updated: November 9, 2007.

Chapter 10. TRAFFIC CALMING

DEFINITION.....	10-2
CATEGORIES.....	10-4
SAFETY.....	10-5
EMERGENCY RESPONSE AND NUMBER OF PERIODIC MEASURES.....	10-7
Exceptions.....	10-8
Design Vehicle.....	10-8
GENERAL POLICY GUIDANCE.....	10-9
Tort Liability.....	10-9
Traffic Calming Contexts.....	10-10
Planning and Design Processes.....	10-15



DEFINITION



*Traffic calmed street
(Credit: Dan Burden)*

Traffic calming is the combination of mainly physical measures that (i) reduce the negative effects of motor vehicle use, (ii) alter driver behavior, and (iii) improve conditions for non-motorized street users.

The phrase, “the combination of mainly physical measures,” means physical measures plus a supportive policy environment such that traffic calming is permitted and encouraged.

“Reduce the negative effects of motor vehicle use” means changing the role and design of streets to accommodate motorists in ways that reduce the negative social and environmental effects on individuals, neighborhoods, districts, retail areas, corridors, downtowns, and society in general (e.g., reduced speeds, reduced sense of intrusion/dominance, reduced energy consumption and pollution, reduced sprawl, and reduced automobile dependence).

“Alter driver behavior” means that the street design helps drivers self-enforce lower speeds, resulting in less aggressive driving and increased respect for non-motorized users of the streets.

“Improve conditions for non-motorized street users” means promoting walking and cycling, changing expectations of all street users to support equitable use of the street, increasing safety and comfort (i.e., the feeling of safety), improving the aesthetics of the street, and supporting the context of the street.

The definition of traffic calming is broad enough to apply to a myriad of contexts and situations but specific enough to have independent meaning so that it is not confused with other street design elements and design approaches.

Through design, traffic calming aims to slow the speeds of motorists to the “desired speed” (usually 20 mph or less for residential streets and 25 to 35 mph for boulevards and avenues) in a context-sensitive manner by working with the stakeholders (i.e., residents, business owners, and agencies). Traffic calming is acceptable on all street types where pedestrians are allowed. Traffic calming is applicable to all sizes of towns and cities as well as rural villages and hamlets.

Traffic calming typically connotes a street or group of streets that employ traffic calming measures with a “self-enforcing” quality that physically encourages motorists to drive at the desired speed. When a group of streets are involved, it is normally referred to as “area-wide calming.”

Traffic calming measures can also be designed to treat and manage streetwater.



Cross section traffic calming measure: Santa Monica, CA (Credit: Ryan Snyder)

CATEGORIES



Periodic traffic calming measure:
Raised crosswalk in Seattle, WA
(Credit: Ryan Snyder)



Partial closure: Riverside, CA
(Credit: Ryan Snyder)

From a policy and design perspective, traffic calming measures fall into two broad categories: those that are appropriate for “framework” streets and those that are appropriate for both framework streets and “non-framework” streets. Framework streets are streets that (i) connect places, neighborhoods, and districts (usually most boulevards and avenues) and/or (ii) serve as emergency vehicle routes. The sorts of traffic calming measures that are appropriate on framework streets include “cross-section measures” because emergency response times are generally unaffected by cross-section changes. Non-framework streets are all the other streets in the street network. The majority of streets in cities are non-framework streets. Non-framework streets provide access to houses, businesses, offices, and parks, and are rarely used by emergency vehicles except for local calls. The sorts of traffic calming measures that are appropriate for non-framework streets include cross-section measures and “periodic measures.” Periodic measures are spaced intermittently, rather than continuously. They are very popular on non-framework streets because they are inexpensive when compared to cross-section measures, which typically require construction along the entire length of the street. Examples of both types of measures and guidance for their use are shown above and below.

The correct terminology for traffic calming measures is “measures” not “devices.” “Devices” implies a degree of portability that does not apply to most traffic calming measures. The use of “devices” also causes confusion with the contents of the Manual of Uniform Traffic Control Devices. Adding street trees and changing the paving material to provide texture or contrast, for example, are measures to alter behavior and perceptions but they are clearly not “devices.”

“Route modifications measures” are not traffic calming measures. Examples of route modifications measures include street closures, partial closures, turn prohibitions, diverters, and one-way streets. Route modifications effectively remove parts of the network. Route modifications result in circuitous and out-of-direction routing. The resulting trips are longer and burn more fuel; thus, circuitous routing can increase driver frustration and result in higher speeds. Route modification should be used sparingly and generally where traffic is diverted to boulevards to reduce cut-through traffic, or on bike boulevards to reduce their use by through motor vehicle traffic.

Lastly, signs and pavement markings are often used in conjunction with traffic calming measures, but they are traffic control devices, not traffic calming measures.

SAFETY

The greatest benefit of traffic calming is increased safety. Compared with conventionally designed streets, traffic calmed streets typically have fewer collisions and even higher reductions in injuries and fatalities. These dramatic safety benefits are mostly the result of slower speeds for motorists that result in greater driver awareness, wider fields of vision, shorter stopping distances, and less kinetic energy during a collision. At 20 mph or less, chances are very high that a motorist will not kill or severely injure a pedestrian in a collision. Other contributing factors to these superior safety results include a more legible street environment and design advantages for pedestrians and cyclists. Bulb-outs on corners of intersections, for example, allow pedestrians to see past parked cars prior to crossing the street.



Peripheral vision decreases at higher speeds (Credit: Michele Weisbart)

The accommodation and comfort of pedestrians increases greatly as speeds lower. For example, acceptable gaps (i.e., the space between moving vehicles) are better judged at slower speeds. Also, at 25 mph or less drivers are much more likely to yield to pedestrians and let them cross the street than at over 25 mph. The chart below shows that it takes a longer distance to brake and come to a full stop as speeds increase.

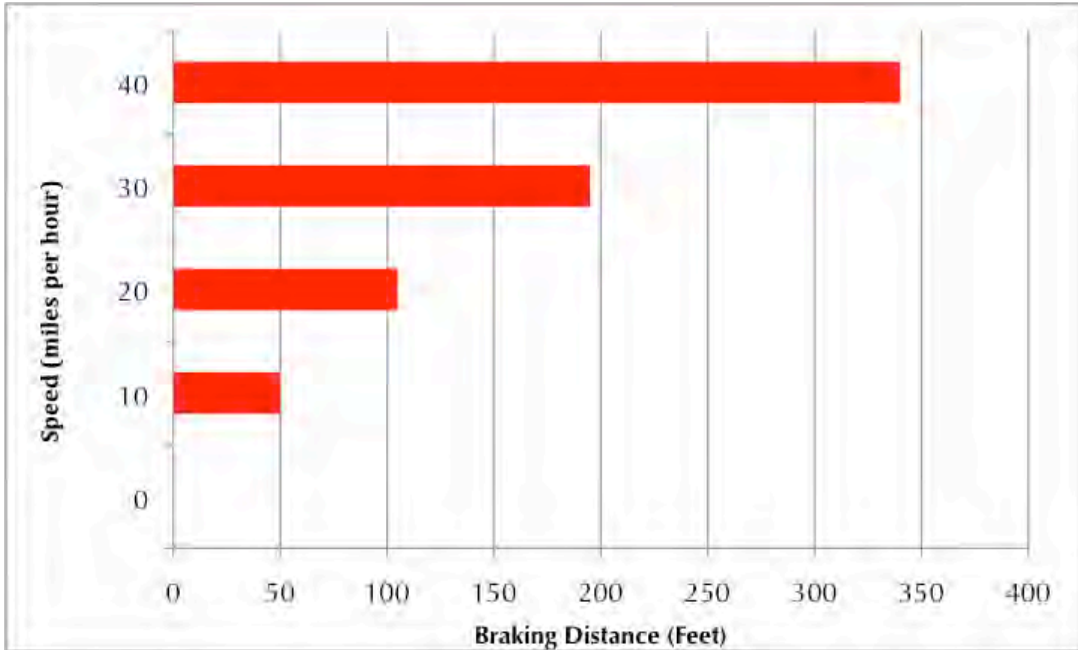

Source: Federal Highway Administration Pedestrian Safety Design Course.

The chart below illustrates that crashes become more severe with speed.

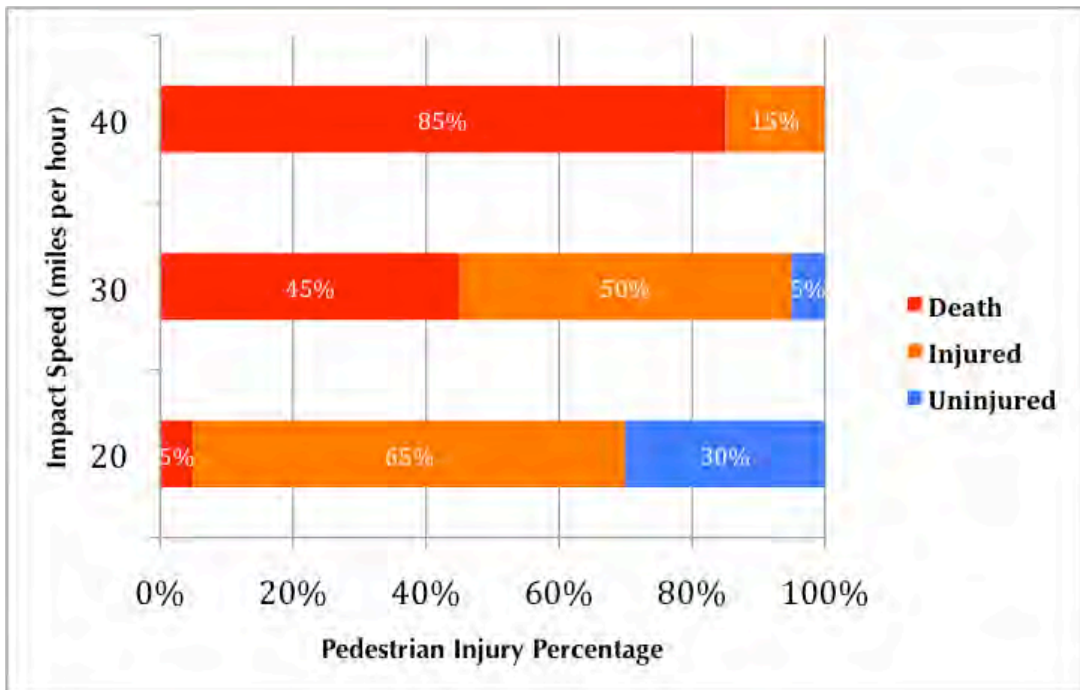

Source: Killing Speed and Saving Lives, UK Department of Transportation.

EMERGENCY RESPONSE AND NUMBER OF PERIODIC MEASURES

It is important to have a network of framework streets so that emergency personnel can get to, or reasonably close to, calls without encountering too many periodic measures. In this way, all or most of the length of the responders' trips are on framework streets and, if any periodic measures are encountered, then they are encountered only towards the end of the trip. From an emergency perspective and a public acceptability perspective, it is important to limit the number of periodic measures in a row on non-framework streets. The rule of thumb is, on the routes between two framework streets there should be no more than 8 to 12 periodic measures. If more than 8 to 12 periodic measures are used in a row, motorists who use the streets will become highly irritated with the measures and will have them removed. This rule of thumb effectively limits the length of single-street traffic calming projects. It also limits the size of the area for area-wide calming (i.e., the maximum limit is 8 to 12 multiplied by the spacing between the measures).

To achieve a desired speed of 20 mph using periodic measures, the spacing between the measures should be about 250 to 300 feet. Typically, measures are constructed at the obvious locations (i.e., pedestrian crossings, intersections, and curves) and then subsequent measures are filled in to attain the correct spacing. In this way, a slow and steady speed profile is achieved; there is little opportunity or utility for motorists to speed up between the measures.



*Designing traffic calming to accommodate emergency response
(Credit: Dan Burden)*

Exceptions

There are two general exceptions to the above recommendations:

- Some local streets should be classified as framework streets due to their long lengths and inability to be effectively calmed with no more than 8 to 12 periodic measures at the correct spacing.
- Periodic measures are appropriate on framework streets in some situations. Examples include locations with heavy pedestrian generators (e.g., at elementary schools, community centers, entertainment venues, and key intersections along a main street or in a downtown).

Design Vehicle

In general, all public streets and traffic calming measures should be designed to accommodate a WB-40 design vehicle (i.e., a tractor trailer with a 40-foot wheel base). The WB-40 design vehicle uses more space to turn than fire trucks, school buses, garbage trucks, and most service trucks. Therefore, if the WB-40 fits, all the rest fit. On streets where larger design vehicles are permitted and are expected to use the streets regularly, then the design vehicle should be changed accordingly. On high frequency bus routes where encroachment into opposing lanes would cause excessive delays to the buses, the affected radii should be altered accordingly. While all streets should be designed to accommodate WB-40 vehicles, they should not be the primary design vehicle on non-framework streets. And this does not mean that every radius must be large enough to accommodate them as large trucks may use the full width of the street they are turning into. These streets should be narrow and require slowing to turn at intersections, especially for large vehicles.

GENERAL POLICY GUIDANCE

For cities initiating a traffic calming policy, the most important items to include are the following:

- The correct definition of traffic calming
- General statements of support for traffic calming throughout the city and experimentation with traffic calming for a variety of rationales
- A chart of examples of acceptable measures on different categories of streets
- A reference to traffic calming practices and procedures that will be maintained at the staff level

The last item is important because cities need the flexibility to adapt their programs, include updated practices and measures as they are developed or discovered, and react to changing circumstances. If practices and procedures are adopted by ordinance or resolution, then the traffic calming policy will be out-of-date quickly or will hamper cities' ability to address unique contexts.

Tort Liability

The low speed environment of a traffic calmed street is a difficult place for someone to be "victimized" by a fault in the road design. Consequently, there are very few tort actions associated with traffic calming. Furthermore, there are fewer collisions and far fewer injuries and deaths on traffic calmed streets than streets with higher speeds. There is no exposure to liability if some simple and routine actions are followed:

- In cities' statements for supporting traffic calming, some broad rationale should be listed so that traffic calming cannot be considered "capricious." Examples should include to increase safety, increase walkability, increase community cohesion, and increase business viability; historic preservation and environmental protection; and to further the goals and objectives of the community and city in a variety of contexts.
- Cities should conduct normal monitoring for maintenance, complaints, incidents, and collisions. This need not be anything more than the normal reporting systems but with some additional attention paid to streets with new modifications.

Traffic Calming Contexts

Early traffic calming efforts in North America started as “programs” and often used a variety of warrants and petitions. However, traffic calming has evolved and there are many reasons to calm traffic; a city doesn’t need special permission or warrants to increase the safety and comfort of its streets. In many ways, traffic calming is synonymous with other terms that are used to encourage better street designs. Depending on the term, the emphasis differs, but in all cases traffic calming measures play a role.

Context-Sensitive Design (CSD)

CSD implies that the context (i.e., the social, historical, physical, fiscal, political, environmental, and policy contexts) drive the design as opposed to the conventional street hierarchy. Typically, conventional practices use general design guidelines that are indifferent to the context. Frequently, contexts along conventional streets in cities suffer from some combination of negative effects of motor vehicle use, poor driver behavior, and poor conditions for non-motorized street users. Consequently, CSD often employs traffic calming measures to respect the context of the street and neighborhood.



Complete street (Credit: Ryan Snyder)

Complete Streets

The term “complete streets” describes streets that comfortably accommodate all the various users of the street, with particular emphasis on pedestrians, cyclists, and transit users, as well as people of all ages and physical abilities. Those street users are more exposed and affected by the street environments than motor vehicle users. Furthermore, their comfort has been routinely ignored by conventional and automobile-oriented design. Often, traffic calming measures are used to provide comfortable accommodation as opposed to technical accommodation. In California, cities are now required to adopt complete streets principles in their circulation elements of their general plans as they are revised.

Many cities are adopting complete streets policies to require that

- Conventional streets be altered into complete streets as the standard operating procedure
- New streets be built as complete streets

Traffic calming measures help to implement these policies.

Smart Transportation

This term describes the transportation aspects of smart growth. The idea is to consider “transportation planning and design” as integral with “land use planning and design,” as opposed to separate ideas. Too often, the two are done by separate specialists and for independent reasons. Traffic calming measures play an important role in the design of all scales of streets in cities when integration with the adjacent land use is desired.

Safe Routes to School

Safe Routes to School includes a series of operational and physical changes that help students walk and cycle to and from schools. Traffic calming measures are routinely employed with other strategies and changes to create safer walking and bicycling routes to school by slowing traffic.

Neighborhood Traffic Management

This term describes the combination of

- Route modifications (e.g., turn prohibitions, closures, partial closures, diverters, and one-way streets) to remove parts of the street network, sever linkages, create mazes, or reduce connectivity
- Unwarranted traffic control devices (e.g., stop signs and traffic signals) to annoy or delay motorists who cut through neighborhoods
- Traffic calming to reduce poor driver behavior (e.g., speeding and aggressive driving)

Please note that in most situations, diminishing the street network is not considered good practice. Bicycle boulevards are a primary exception to this rule; traffic control devices are desirable on bicycle boulevards to discourage through motor vehicle traffic. Route modification may also be used to reduce cut-through traffic where the traffic will be diverted to a boulevard.



*Shared space: Groningen, Holland
(Credit: Ryan Snyder)*

Shared Space

Shared space uses the design of the public realm (i.e., the space between the buildings) to cause all of the street users to communicate, interact, and behave safely without (i) the reliance on conventional traffic control devices doing the communicating for them, and (ii) the conventional allocation of separate lanes/spaces that accompany the conventional and often less safe “safety-through-separation” theories. Many traffic calming measures, such as texture, paving color changes, lateral shifts, and enclosure, are employed in shared spaces.

Road Diet

This term describes the narrowing and/or removal of motor vehicle lanes from the cross-section. Both of these changes are traffic calming measures. Typically, the reclaimed space is used for other purposes such as wider sidewalks, landscaped spaces, bicycle lanes, linear parks, and/or on-street parking. Often, road diet projects employ other traffic calming measures as well. Roundabouts often enable implementation of road diets, especially on busier boulevards since they have greater capacity to handle traffic at intersections with fewer lanes than other controls.

Competent Street Design

Competent street design combines all of the above. There is little excuse any more to ignore the context or to build incomplete, dangerous, or poorly integrated streets. The issue for traffic calming is not justification but prioritization. If there are problems with a conventionally designed street, then traffic calming is warranted. The questions are how to calm, when to calm, and how the project compares to other priorities in the city.



Curb extensions enhance retail districts: Asheville, North Carolina (Credit: Ryan Snyder)

Obviously, an early priority for any city is to incorporate traffic calming measures into normal street design practices and procedures to help any new/future streets avoid the deficiencies of conventionally designed streets. The harder part is prioritizing the rebuilding or retrofitting of the myriad of already built conventionally design streets. Rebuilding or retrofitting these streets should be prioritized based on the context, in the broadest sense. Candidates for calming might include the following:

- Key shopping streets in the downtown area
- Waterfront streets, which commonly attract pedestrians who would benefit if the streets were calmed
- Neighborhood streets
- Large arterials (boulevards) that create barriers in the city

Consequently, allocating street redesign money based on warrants or numerical scores is not recommended because the contexts and scope vary too much. In the early days of North American traffic calming, special traffic calming programs were established with warrants that focused primarily on motor vehicle speeds, volumes, and collisions on residential streets. Warrants were popular in the early traffic calming programs because, at the time, traffic calming was new and unfamiliar. Traffic calming was thought of as an independent program for residential streets only.

Scoring schemes are problematic. For example, if a threshold score is exceeded on one block or at one intersection but nowhere else on the street, traffic calming the one location does not make sense. A single periodic measure used alone that does not result in a slow and steady speed profile is known as an “orphan.” Periodic traffic calming measures rely on other measures along the street at the correct spacing to be most effective. Furthermore, the individual score or warrant cannot anticipate shifting a problem to a parallel street. In other words, the scoring systems cannot anticipate transfer effects. Area-wide calming requires judgment.

Numerical scores leave out key contextual considerations (i.e., school area, retail area, parks, presence of sidewalks, right-of-way widths, and building setbacks) and thus are incomplete. Many scoring schemes rank projects on auto-related criteria such as volume, speed, crashes, etc. This method ignores other street users such as pedestrians and cyclists. The scores require a lot of effort to gather, analyze, and compare. They also provide a false sense of objectivity because the fundamental choice of what to measure is subjective as is the weighting of the measures. It is difficult to correlate the scoring with a city’s, district’s, downtown’s, corridor’s, or neighborhood’s vision, goals, objectives, and broader priorities. These priorities may include revitalization, community cohesion, housing, or others.

Instead, traffic calming should be a normal part of a city’s, district’s, downtown’s, corridor’s, or neighborhood’s plans and a normal part of the budgeting process. It should be incorporated into resurfacing, utility replacement, and other programs. Every time a conventional street gets attention, the replacement design should include traffic calming as normal practice. Traffic calming should be the rule, not the exception, and special permission to not calm should be sought in those instances. Competing areas, neighborhoods, and districts that want traffic calming need to express their desires through the normal planning and capital works programs.

Requiring petitions is not recommended either, as they can be expensive, distracting, and divisive. Outcomes can vary depending on the wording of the petition; the business people’s, property owners’, and residents’ understanding of the related issues; and the people who are collecting the signatures. Petitions can make the task of designing a context-sensitive, traffic calmed street very difficult.

Traffic Calming and Streetwater Management

Traffic calming measures, such as bulb-outs, roundabouts, traffic circles, chicanes, lane narrowing, and others, can be used as streetwater management tools. Some of these can create space for bioretention, detention, and pervious pavement.

Planning and Design Processes

Traffic calming should be a normal part of any city's planning and design processes. The processes will vary dramatically depending on the context. For example, implementing a road diet in conjunction with a transit facility along a five-mile boulevard would require a different process than reverting one-way streets back to two-way operation in a downtown. Similarly, a neighborhood traffic calming plan would require a different process than designing a people-friendly Main Street. Also, identifying boulevard streets that are barriers in a city during comprehensive planning would require a different process than altering streets on a college campus or hospital campus.

The common threads that link all of the processes include the following:

- Gaining a good understanding of the context
- Involving the stakeholders in the definition of the problems to be solved and aspirations to be fulfilled
- Educating the stakeholders such that they can have meaningful involvement
- Aligning the project with a broader vision for the area
- Achieving an informed consent regarding the plan

Traffic calming is best done in conjunction with a development, revitalization, utility, or maintenance project; a downtown, corridor, or transit plan; a new street design; or other project. Then the traffic calming layer is simply incorporated into the larger project's processes.

The table below illustrates acceptable traffic calming measures on various types of streets.

Table 10.1: Representative Examples of Traffic Calming Measures and their Appropriateness on Various Street Categories

Traffic Calming Classification		Framework Street			Framework Street or Non-Framework Street		Non-Framework Street
		Boulevards in Transition (partially calmed)	Regional Boulevard	Community Boulevard	Community Avenue	Neighborhood Avenue	Local Street
Conventional Street Classification							
Posted/Design/Target/Operating Speed (mph)		35 mph +	25 to 30 mph	20 to 30 mph	20 to 30 mph	20 to 25 mph	20 mph or below
Transition Zone from/to higher speed environment							
Entrance Features (architecture/landscaping/monument)							
Cross-Section Measures	Reduction in number of lanes						
	Reduction in width of lanes						
	Long Median / Continuous Median						
	Short Median / Refuge						
	Short Medians on Curves						
	Bulb-outs						
	Curb and Gutter						
	Curbless / Flush Streets						
	Flush Medians						
	Pedestrian Scale Lighting						
	Street Trees						
	Building up to the right-of-way						
	Lateral Shifts						
	Shared Spaces						
	Bike Lanes / Protected Bike Lanes / Cycle Tracks						
	Textured and/or Colored Paving Materials (parking, lanes, bike lanes, crossings, intersections, general purpose lanes, turn lanes, medians)						
	On-Street Parking	Parallel					
Back-in angled							
Front-in angled							
Right-angle							
Valley gutters used in conjunction with parking							

Legend on following page (10-17).

Table 10.1 continued

Traffic Calming Classification			Framework Street			Framework Street or Non-Framework Street		Non-Framework Street
Periodic Measures	Horizontal Measures	Roundabouts	Appropriate	Appropriate	Appropriate	Appropriate	Appropriate	Appropriate
		Mini-Roundabouts	Not Appropriate	Appropriate	Appropriate	Appropriate	Appropriate	Not Appropriate
		Mini Traffic Circles	Not Appropriate	Not Appropriate	Not Appropriate	Appropriate	Appropriate	Appropriate
		Impellers (T-intersections)	Not Appropriate	Not Appropriate	Not Appropriate	Appropriate	Appropriate	Appropriate
		Two-lane chicanes	Not Appropriate	Not Appropriate	Not Appropriate	Appropriate	Appropriate	Appropriate
		One-lane chicanes (yield condition)	Not Appropriate	Not Appropriate	Not Appropriate	< 3,000 ADT	< 3,000 ADT	< 3,000 ADT
		Short medians	Not Appropriate	Not Appropriate	Not Appropriate	Appropriate	Appropriate	Appropriate
		Medians on curves	Not Appropriate	Not Appropriate	Not Appropriate	Appropriate	Appropriate	Appropriate
	Narrowings	Yield Streets	Not Appropriate	Not Appropriate	Not Appropriate	< 1,500 ADT	< 1,500 ADT	< 1,500 ADT
		Pinch Points	Not Appropriate	Not Appropriate	Not Appropriate	< 3,000 ADT	< 3,000 ADT	< 3,000 ADT
		Bulb-outs	Appropriate	Appropriate	Appropriate	Appropriate	Appropriate	Appropriate
	Vertical Measures	Raised Intersections	Appropriate on specific circumstances	Appropriate on specific circumstances	Appropriate on specific circumstances	Appropriate	Appropriate	Appropriate
		Raised Crosswalks	Appropriate on specific circumstances	Appropriate on specific circumstances	Appropriate on specific circumstances	Appropriate	Appropriate	Appropriate
		Flat-top Speed Humps (speed tables)	Not Appropriate	Not Appropriate	Not Appropriate	Appropriate	Appropriate	Appropriate
		Speed Cushions	Not Appropriate	Not Appropriate	Not Appropriate	Appropriate	Appropriate	Appropriate
Speed Humps		Not Appropriate	Not Appropriate	Not Appropriate	Appropriate	Appropriate	Appropriate	
Not Traffic Calming Measures	Vertical Changes	Rumble Strips (for warning purposes)	in rural areas only	Not Appropriate	Not Appropriate	Not Appropriate	Not Appropriate	Not Appropriate
		Speed Bumps	Not Appropriate	Not Appropriate	Not Appropriate	Not Appropriate	Not Appropriate	Not Appropriate

Note: Many of these measures can be combined in a variety of ways that are too numerous to list in this chart.

Legend	Appropriate
	Appropriate on specific circumstances
	Not Appropriate

Chapter 10. Traffic Calming

The following photos illustrate some of these measures.



Reduction in widths (Credit: Ian Lockwood)

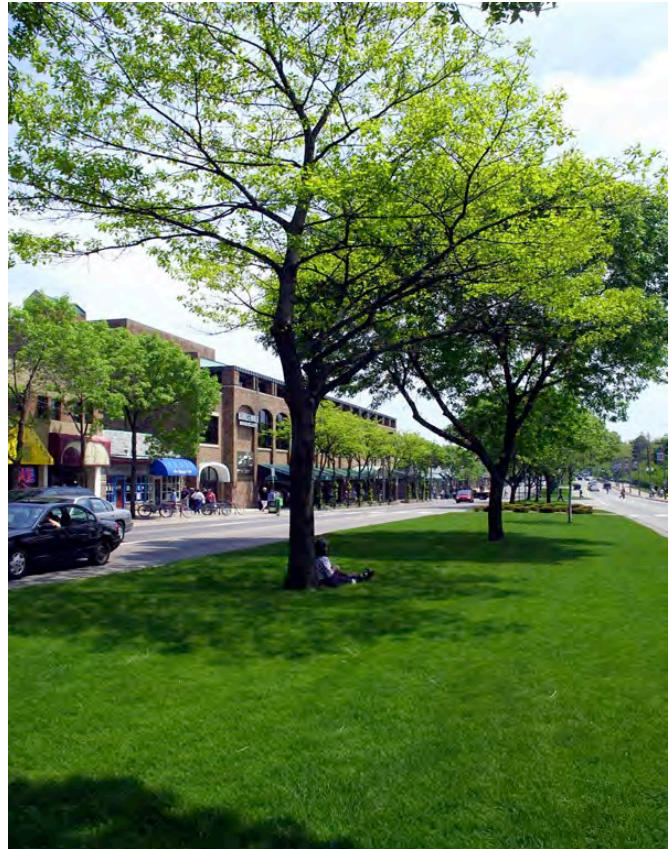

Long, continuous median (Credit: Ian Lockwood)



Short median with refuge (Credit: Ian Lockwood)



Short median on curve (Credit: Michael Wallwork)



Curbless, flush street (Credit: Ian Lockwood)



Curbless median (Credit: Ian Lockwood)



Tree canopy (Credit: Ian Lockwood)



Lateral shifts (Credit: Ian Lockwood)

Chapter 10. Traffic Calming

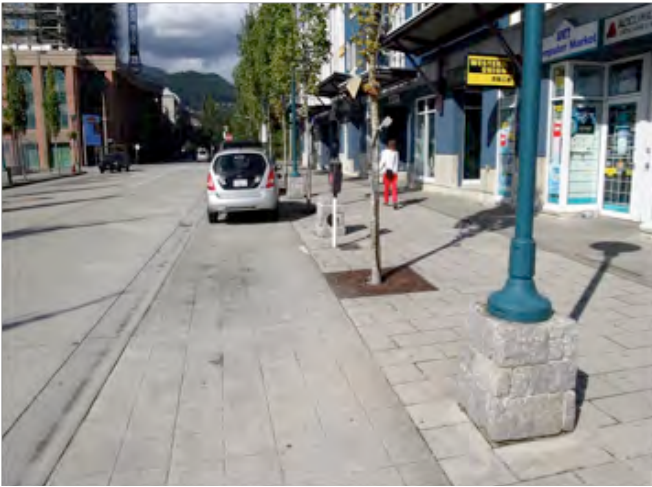

Valley gutter (Credit: Ian Lockwood)



Textured pavement (Credit: Ian Lockwood)



Mini-roundabout (Credit: Ian Lockwood)



Roundabout (Credit: Michael Wallwork)



Impeller T-intersection
(Credit: Ian Lockwood)



Two-lane chicane (Credit: Michael Wallwork)



Traffic circle with rain garden (Credit: Brad Lancaster)



One-lane chicane (Credit: Ian Lockwood)



Short median (Credit: Ian Lockwood)



*Raised intersection.
(Credit: Ian Lockwood)*



*Raised crosswalk.
(Credit: Ian Lockwood)*



*Speed cushion.
(Credit: Ian Lockwood)*



Oval median. (Credit: Michael Wallwork)



Oval median with tree wells. (Credit: Gary Crammer)



Mid-block curb extension with bioswale. (Credit: Brad Lancaster)

Chapter 11. STREETSCAPE ECOSYSTEM

INTRODUCTION.....	11-2
PRINCIPLES OF STREETSCAPE ECOSYSTEM DESIGN.....	11-2
STREETWATER MANAGEMENT.....	11-3
Goals and Benefits of Streetwater Management.....	11-5
Principles of Streetwater Management.....	11-6
Definitions.....	11-7
Tools for Streetwater Management.....	11-9
URBAN FORESTRY.....	11-31
Street Trees.....	11-32
Understory Landscaping.....	11-39
STREET FURNITURE.....	11-42
Benches and Seating.....	11-44
Bollards.....	11-45
Street Vendor Stands.....	11-46
Informational Kiosks.....	11-46
News Racks.....	11-47
Parking Meters.....	11-48
Signs.....	11-49
Refuse Receptacles.....	11-49
Public Art.....	11-50
Sidewalk Dining.....	11-51
Other Streetscape Features.....	11-52
UTILITIES.....	11-52
Guidelines.....	11-53
Lighting.....	11-58
ADDITIONAL SELECT RESOURCES.....	11-60



INTRODUCTION

The street is a system: a transportation system, an ecosystem, and a system of social and economic interactions. The idea of a streetscape ecosystem is to mimic nature, building reciprocal relationships within an interconnected system to sustainably enhance the local environment, its resources, the community, and the local economy. To do this, the tools addressed in this chapter should be integrated with those of the other chapters in this manual.

This chapter is organized into sections based on a natural hierarchy. The first section focuses on streetwater management because water is the fundamental ingredient for other components of a streetscape ecosystem. The streetwater management section provides guidance on how to work with and maximize the beneficial aspects of rain, its byproduct, stormwater, and other sources of water. The second section addresses street trees and landscaping, providing guidance on how to design streets to include site-appropriate vegetation that maximizes environmental and social benefits. Canopy trees provide summer shade that cools the streets and the hardscapes from which the streetwater is harvested. These sheltered micro-climates create ideal locations for people to gather, walk, and bike.

To help cities achieve street designs that create great places fostering community, the final sections of this chapter address street furnishings, utilities, and lighting. The sections recommend that these elements (e.g., sheltered benches, bike racks, and bus shelters) should be placed where people can utilize them well. These sections also provide guidance as to the placement of utilities and how placement coordinates with other components of the streetscape. The elements described can help attract pedestrians to a street and thereby make the street safer, more dynamic, and more vibrant economically.

PRINCIPLES OF STREETSCAPE ECOSYSTEM DESIGN

Each section in this chapter includes design principles followed by tools to achieve these principles. These streetscape element-specific principles collectively support both the overarching principles of this chapter and the broader goals of this manual. The collective use of the tools in this chapter can provide numerous aesthetic and functional elements in the public rights-of-way, including the entire space between buildings, traveled way, and sidewalks. The following overarching principles should be applied:

- **Coordinate all streetscape elements with traveled way design to maximize ecological, economic, and social benefits.** No individual street project should be pursued in a vacuum, but rather planned as part of a comprehensive strategy. Use street medians, roundabouts, chicanes, curb extensions, and other road configurations as space for people and nature. They provide opportunities for spaces with vegetation, streetwater management tools, and other streetscape elements like benches and bike racks.
- **Create a contextualized sense of place.** Using the large menu provided in this chapter, select streetscape elements that reflect the context and unique character of the location as well as support connections to adjacent land uses. The street can then function as a shared living room for the community and a welcoming front door for the buildings along the street. Native plantings can be used to root the context in the surrounding natural landscape while acknowledging the local ecosystem and climate.

STREETWATER MANAGEMENT

The street is a constructed waterway, often differing from the natural path of water and disconnected from the hydrologic cycle. Traditional design has focused on speedy removal of water from the street and disposal of it as waste in storm drains and sewers. This section provides tools to reclaim streetwater as a resource and allow it to nourish trees and soils on its path to ground or surface waters. These tools help cities design streets to sustainably work with both dry and wet weather sources of water. During the wet season (winter in Southern California), rain and its byproduct, stormwater, are the primary sources of streetwater. During the dry season (summer in Southern California), man-made sources of water include urban runoff from irrigation, car washing, and other residential, commercial, and industrial activities.

Both dry and wet weather streetwater can contain bacteria and other pollutants, and are thereby regulated at the state and local level. Streets represent a large percentage of the impervious area within Los Angeles and therefore generate substantial amounts of runoff from storm events. Many of the sources of pollutants to waterways come from streets, which contain oils, rubber, metals, and galvanized materials from automobiles.

While conventional stormwater controls aim to move water off-site and into storm drains as quickly as possible, streetwater management seeks to use and store water on-site for absorption and infiltration in order to clean it naturally and use it as a resource. The storm drain system, therefore, is an overflow support system rather than a primary conveyance system. Streetwater management deals with water as an amenity rather than a liability.

Many of the streetwater management options discussed in this section can and should integrate easily with traffic calming measures installed along streets, such as boulevard islands, rotary islands, traffic circles, street ends, chicanes, and curb extensions. These elements can easily incorporate streetwater treatment into the landscape and streetwater tools can be made more cost-effective if integrated early in the design process.

Streetwater management also provides opportunities to leverage other streetscape elements and components of living streets. A strategic plan linking streetscape elements and street design can maximize benefits.



Parkway incorporating streetwater tools: Bicknell Avenue, Santa Monica, CA (Credit: Neil Shapiro)

This section provides guidance to comply with the Los Angeles Regional Water Quality Control Board's Municipal Separate Storm Sewer System (MS4) Permit. The MS4 Permit requires that jurisdictions in Los Angeles County reduce contaminants in runoff to improve water quality in waterways. These requirements stem from National Pollutant Discharge Elimination System (NPDES) requirements of the Clean Water Act, as promulgated by the U.S. Environmental Protection Agency and delegated to the Los Angeles Regional Water Quality Control Board.

Goals and Benefits of Streetwater Management

The primary goals of streetwater management are as follows:

- Reduce—limit the amount of impervious surfaces that generate additional runoff
- Slow—friction slows flow
- Spread—allow water to be slowed enough to infiltrate
- Sink—keep water on site
- Store—contain water for direct non-potable/potable indoor/outdoor purposes
- Use—to irrigate and replace imported potable water

These goals can be expressed succinctly: slow it, spread it, store it, and sink it, but use it.

The tools provided in this section enable cities to attain regulatory compliance and provide the following ecological, economic, and aesthetic benefits:

- Reduced use of potable water for irrigation
- Reduced surface water pollution
- Support for the urban ecosystem and wildlife habitat
- Enhanced flood control
- Biological filtration and bioremediation
- Groundwater recharge

- Reduced heat island effect
- Education through best management practices (BMP) visibility
- Aeration of root zone
- Potential reductions in stormwater infrastructure and treatment costs
- Improved aesthetics and public space within neighborhoods

Principles of Streetwater Management

- **Use the conventional storm drain system as the overflow approach, not the primary system to manage streetwater.** Wherever possible, natural drainages should be the primary overflow.
- **Harvest, use, and/or store stormwater as close to its source as possible.** Wet weather rainfall and its byproduct, stormwater, can offset or eliminate imported potable irrigation water needs when harvested and used on-site. Harvesting and storing stormwater transforms a flooding liability into an on-site irrigation resource. This ensures natural waterways and their plant communities have local sources of water, thereby reducing the need for imported water. Harvesting and storing rainwater also reduces the need for costly drainage conveyance infrastructure for stormwater management.
- **Use on-site non-potable water sources for irrigation before any imported water source.** In dry weather, irrigation overspray can be reduced by enforcing existing laws/ordinances banning these practices. This leads to more efficient water use, reducing costly imported potable water consumption.
- **Select tools that mimic natural processes.** Minimize the cost of the installation and maintenance by using gravity flow rather than pumped flow, living filtration over synthetic/mechanical filtration, and living surface infiltration instead of piped drainage. Priority should also be given to pervious versus impervious surfaces. The primary purpose is to harvest and utilize rain as part of a healthy vegetated watershed. For example, vegetation can reduce runoff water volume and pollutant load, provide summer shade and cooling, and enhance wildlife

habitat and sense of place with native vegetation rooted to the local ecosystem.

- **Maximize streetwater management by integrating it into the myriad design elements in the public right-of-way.** The water system is part of a larger, interconnected system. Maximize the benefits of stormwater strategies. For example, traffic calming and road diets can double as streetwater harvesting strategies. In addition, use vegetation to make streets better places and use streetwater management as an integral element of the urban forest.
- **Show the water flow.** The benefits of streetwater management are ecological, economic, and social. Make the functions described in this section visible for street users to see, understand, appreciate, and replicate. Public right-of-way streetwater installations can inspire private property installations and serve as model installations for neighborhoods. Visible water flow systems are also easier to maintain. Blockages are easier to notice and easier to access for regular maintenance.

Definitions

The terms below describe the elements and techniques of sustainable streetwater management.

Best Management Practice (BMP). Operating methods and/or structural devices used to reduce stormwater volume, peak flows, and/or pollutant concentrations of stormwater runoff through one or more of the following processes: evapotranspiration, infiltration, detention, filtration, and biological and chemical treatment

Bioretention. A soil and plant-based retention practice that captures and biologically degrades pollutants as water infiltrates through sub-surface layers containing microbes that treat pollutants. Treated runoff is then slowly infiltrated and recharges the groundwater. These biological processes operate in all infiltration-based strategies, including various retention systems.

Conveyance. The process of water moving from one place to another

Daylight. To bring stormwater or streetwater flow to the surface, exposed to open air and visible to the public

Design Storm. A storm whose magnitude, rate, and intensity do not exceed the design load for a storm drainage system or flood protection project

Detention. Stormwater runoff that is collected at one rate and then released at a controlled rate. The difference is held in temporary storage.

Dry weather runoff. Human activity-related sources of water, such as irrigation overspray, car wash runoff, leaking plumbing, fire hydrant and well flushing, and runoff from mechanical processes such as air conditioning

Filtration. A treatment process that allows for removal of solid (particulate) matter from water by means of porous media such as sand, soil, vegetation, or a man-made filter. Filtration is used to remove contaminants.

Hardscape. Impermeable surfaces, such as concrete or stone, used in the landscape environment along sidewalks or in other areas used as public space

Infiltration. The process by which water penetrates into soil from the ground surface

Permeability/Impermeability. The quality of a soil or material that enables water or air to move through it, and thereby determines its suitability for infiltration-based stormwater strategies

Retention. The reduction in total runoff that results when stormwater is diverted and allowed to infiltrate into the ground through existing or engineered soil systems

Runnel. Narrow, shallow drainage channel designed to carry small amounts of runoff

Runoff. Water from rainfall that flows over the land surface that is not absorbed into the ground

Sedimentation. The deposition and/or settling of particles suspended in water as a result of the slowing of the water

Softscape. Natural, permeable, landscape surfaces such as vegetation, mulch, and loose rock

Stormwater. Rainwater that flows and collects in the street

Streetwater. All waters flowing in the street or other hardscapes in the right-of-way, whether from dry weather runoff or rainwater sources

Tools for Streetwater Management

There are many tools and best management practices (BMPs) for managing streetwater sustainably. Most popular are devices and practices that encourage water percolation on-site to the maximum degree practicable (given soil conditions, pollutant levels, etc.). The most important devices and practices are bioretention BMPs consisting of swales, planters, and vegetated buffer strips, as well as detention BMPs consisting of rain gardens, infiltration trenches, and dry wells. While permeable paving also slows and retains streetwater, it is listed separately because its primary function is to serve as a surfacing material that reduces runoff. Additional tools include delivery and conveyance tools and inlet protections.

The streetwater management tools mentioned in this manual are highly customizable and can be integrated into a variety of different types of spaces in any of the street types. They can be implemented alone or in concert with one another to achieve cumulative benefits. Opportunity sites include medians, corner and midblock curb extensions, roadway and park edges, front building edges, and surrounding street trees. Selecting the appropriate BMP is very dependent on street type and site conditions. High traffic commercial streets have different parameters than smaller residential streets.

The following sections describe techniques to site and construct systems to integrate streetwater management tools into both new and existing streets. Table 11.1 below describes typical applicability of specific streetwater tools to individual street types.

Table 11.1 Best Fit for Streetwater Tools by Street Context

	STREET CONTEXT	BIORETENTION			DETENTION		PAVING	DELIVERY AND CONVEYANCE	INLET PROTECTIONS		
		Swales	Planters	Vegetated Buffer Strips	Rain Gardens	Infiltration Trenches and Dry Wells	Permeable Paving	Channels and Runnels	Screens	Inlet Inserts	Pipe Filters
Commercial	Downtown Commercial		0			0	0	0	0	0	0
	Commercial Thoroughway		0	0		0	0	0	0	0	0
	Neighborhood Commercial		0	0	0	0	0	0	0	0	0
Residential	Downtown Residential	0	0		0	0	0	0	0	0	0
	Residential Thoroughway	0	0		0	0	0	0	0	0	0
	Neighborhood Residential	0	0		0	0	0	0	0	0	0
Industrial And Mixed-Use	Industrial	0	0		0	0	0	0	0	0	0
	Mixed-Use		0	0		0	0	0	0	0	0
Special	Sidewalk Furniture Zone	0	0		0	0	0	0	0	0	0
	Park Edge	0	0		0	0	0	0	0	0	0
	Boulevard	0	0		0	0	0	0	0	0	0
	Ceremonial (Civic)						0	0	0	0	0
Small	Alley		0			0	0	0	0	0	0
	Shared Public Way		0			0	0	0	0	0	0
	Walk Street		0	0		0	0	0	0	0	0

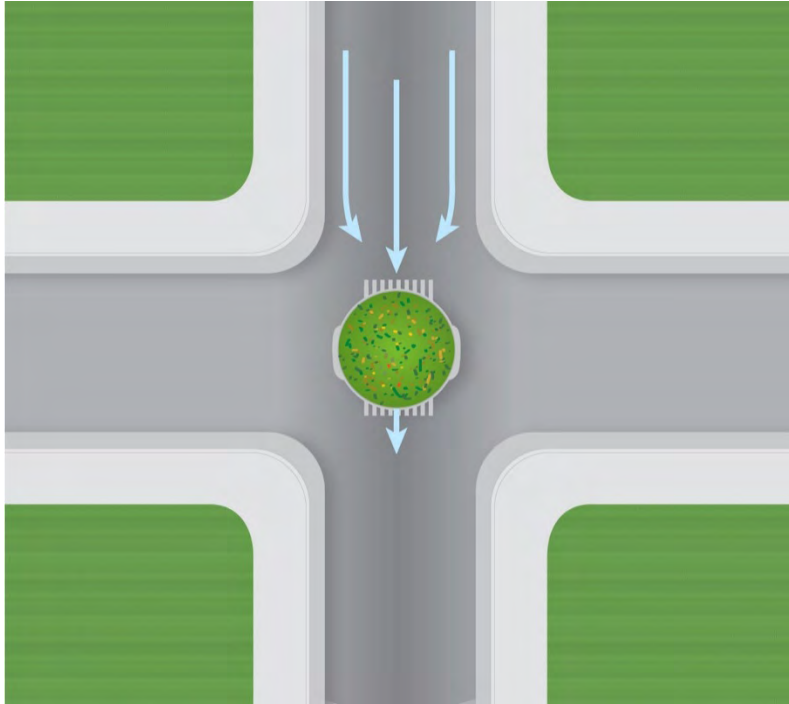

*Rain garden in rotary island
(Credit: Michele Weisbart)*

General Guidelines

Site Considerations

Streetscape geometry, topography, and climate determine the types of controls that can be implemented. The initial step in selecting a streetwater tool is determining the available open space and constraints. Although the maximum size of a selected streetwater facility may be determined by available area, the standard design storm should be used to determine the appropriate size, slope, and materials of each facility.

After identifying the appropriate streetwater facilities for a site, an integrated approach using several tools is encouraged. To increase water quality and functional hydrologic benefits, several streetwater management tools can be used in succession. This is called a treatment train approach. The control measures should be designed using available topography to take advantage of gravity for conveyance to and through each facility.

Traffic calming measures, such as medians, circles, chicanes, and curb extensions, should integrate streetwater management options discussed in this section. The first image below illustrates a center-draining street utilizing a rain garden integrated into a circle. These areas offer ideal opportunities for treating runoff as they typically intercept the flow path

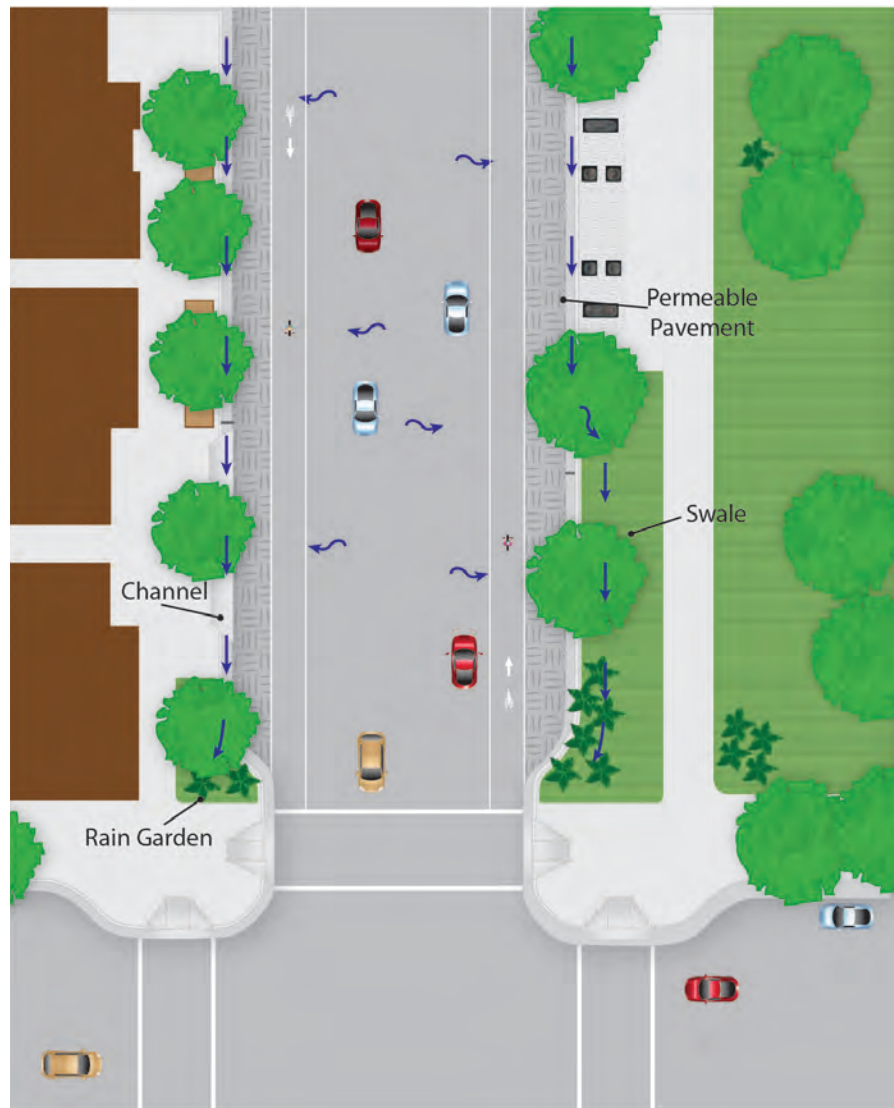

*Crowned complete street
(Credit: Michele Weisbart)*

of water along a street and provide additional surface and subsurface space for treating and infiltrating streetwater. By integrating streetwater management tools at an early design stage, new facilities can be added with only marginal cost when paired with other streetscape construction projects. The second image below illustrates a possible treatment on a traditional crowned street with traffic calming measures.

Infiltration Considerations

Appropriate soils, infiltration media, and infiltration rates should be used for infiltration BMPs. Ideally, a complete geotechnical or soils report should be undertaken to determine infiltration rates, soil toxicity and stability, and other factors that will affect the ability and the desirability of infiltration. At a minimum, the infiltration capacity of the underlying

soils should be deemed suitable for infiltration and appropriate media should be used in the BMP itself.

Using certain techniques, streetwater tools can still be incorporated into areas of low permeability or where infiltration of stormwater is not desirable. Underdrains should be used in areas of low soil permeability. The location of the underdrain is an important consideration: if placed higher in a facility, the stored water below the perforated pipe will be infiltrated. If placed at the bottom of a sealed system, the perforated pipe will release the stored water slowly over time. These infiltration BMPs may overflow to appropriate locations such as catch basins and outfalls.

Details are important to the ultimate success or failure of an infiltration system. Poor soil conditions may cause stormwater to infiltrate either too fast or too slow. Over-compaction of subsurface soil during construction can lead to reduced infiltration capacity, flooding, and ponding. The bottom surface of infiltration areas should be level to allow even distribution. Soils and gravels in an infiltration installation should be meticulously specified and verified in the field during construction. Proper maintenance is crucial to the success of an infiltration BMP. To ensure proper caretaking, a maintenance plan or contract with a local agency is necessary.



*Swale: Long Beach, CA
(Credit: Patricia Smith)*

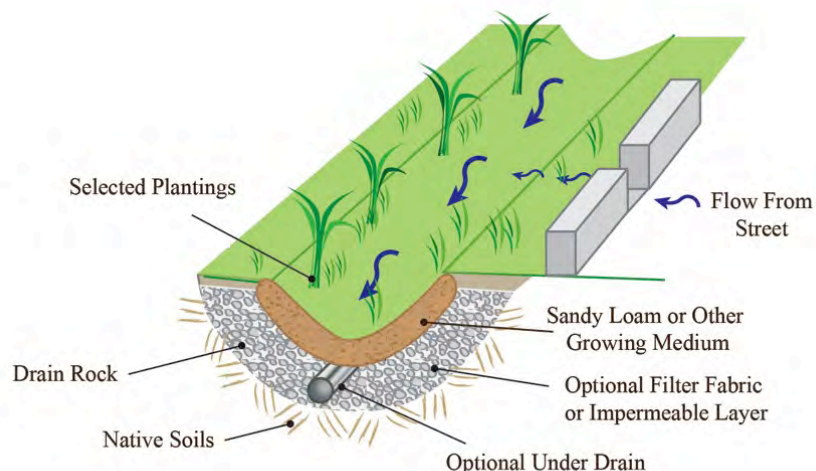

*Established swale in the landscape
(Credit: Julia Campbell and Michele Weisbart)*

Bioretention

Bioretention is a stormwater management process that cleans stormwater by mimicking natural soil filtration processes as water flows through a bioretention BMP. It incorporates mulch, soil pores, microbes, and vegetation to reduce and remove sediment and pollutants from stormwater. Bioretention is designed to slow, spread, and, to some extent, infiltrate water. Each component of the bioretention BMP is designed to assist in retaining water, evapotranspiration, and adsorption of pollutants into the soil matrix. As runoff passes through the vegetation and soil, the combined effects of filtration, absorption, adsorption, and biological uptake of plants remove pollutants.

For areas with low permeability or other soil constraints, bioretention can be designed as a flow-through system with a barrier protecting streetwater from native soils. Bioretention areas can be designed with an underdrain system that directs the treated runoff to infiltration areas, cisterns, or the storm drain system, or may treat the water exclusively through surface flow.

Included in this section are discussions of swales, planters, and vegetated buffer strips.

Location and Placement

Bioretention facilities can be included in the design of all street components: adjacent to the traveled way and in the frontage or furniture sidewalk zones. They can be designed into curb extensions, medians, traffic circles, roundabouts, and any other landscaped area.

Depending on the feature, maintenance and access should always be considered in locating the device. Bioretention systems are also appropriate in constrained locations where other stormwater facilities requiring more extensive subsurface materials are not feasible.

If bioretention devices are designed for infiltration, native soil should have a minimum permeability rate of 0.5 inches per hour and at least 10 feet to the ground water table. Sites that have more than a 5 percent slope may require other stormwater management approaches or special engineering.

Guidelines

A sponge-like surface application of organic mulch can quicken the rate of absorption into the soil, slow soil moisture loss to evaporation, and reduce the solid waste stream if the mulch is generated from local organic matter. This strategy can also intercept and reduce sediment and nutrient concentrations in runoff via bioremediation.

Plants should be microclimate-appropriate and must be able to tolerate occasional saturation as well as dry periods (see the Urban Forestry section of this chapter for planting recommendations).

The use of multiple small devices is often more feasible in tight urban environments than the use of one large device. Small systems can be linked together to achieve the desired cumulative capacity.



Sidewalk-adjacent swale during storm event (Credit: Edward Belden, Los Angeles and San Gabriel Rivers Watershed Council)

Swales

Swales are linear, vegetated depressions that capture rainfall and runoff from adjacent surfaces. The swale bottom should have a gradual slope to convey water along its length. Swales can reduce off-site streetwater discharge and remove pollutants along the way. In a swale, water is slowed by traveling through vegetation on a relatively flat grade. This gives particulates time to settle out of the water while contaminants are removed by the vegetation. Because the vegetation receives much of its needed moisture through streetwater, the need for irrigation is greatly reduced.



*Swale with curb cut opening and decorative grate outlet
(Credit: AHBE Landscape Architects)*

Location and placement. Swales can easily be located adjacent to roadways, sidewalks, or parking areas. Roadway runoff can be directed into swales via flush curbs or small evenly-spaced curb cuts into a raised curb. Swale systems can be integrated into traffic calming devices such as chicanes and curb extensions.

Swales can be placed in medians where the street drains to the median. Placed alongside streets and pathways, vegetated swales can be landscaped with native plants which filter sediment and pollutants and provide habitat for wildlife. Swales should be designed to work in conjunction with the street slope to maximize filtration and slowing of streetwater.

Guidelines. Soils that promote absorption and support vegetation, such as sandy loams, should be specified on a case-by-case basis. Base layers of rock and stabilizing filter fabric may also be specified. Swale length, width, depth, and slope should be determined by capacity needed for treatment of the design storm.

Swales are designed to allow water to slowly flow through. Depending on the landscape and design storm, an overflow or bypass for larger storm events may be needed. Curb openings should be designed to direct flow into the swale. Following the inlet, a sump may be built to capture sediment and debris. Mulch can be used in systems where it will not escape the swale system, such as in flatter, deeper swales. Check dams should be used to slow the velocity of water and catch sediment when the slope along the length of the swale exceeds 4 percent.

Swales should be landscaped with deep-rooted grasses and vegetation that tolerate short periods of inundation, deposits of sediment, and periods of drought. Vegetation will filter sediment and slow erosion, protecting the swale from failure. The sides of swales should be minimally sloped to protect the swale from erosion and slope failure.



Planter along a downtown street
(Credit: Kevin Robert Perry)

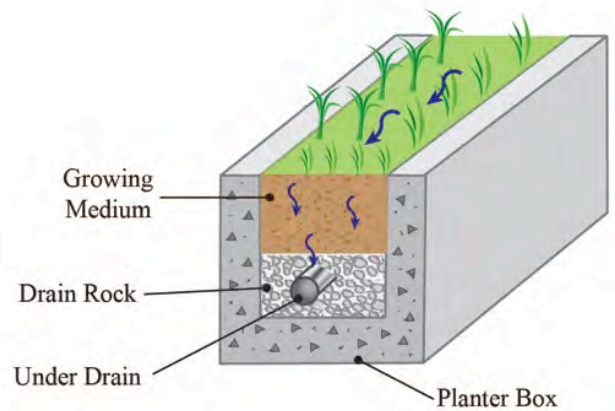

Planter detail
(Credit: Julia Campbell and Michele Weisbart)

Planters

Planters are typically above-grade or at-grade with solid walls and a flow-through bottom. They are contained within an impermeable liner and use an underdrain to direct treated runoff back to the collection system. Where space permits, buildings can direct roof drains first to building-adjacent planters. Both underdrains and surface overflow drains are typically installed with building-adjacent planters.

At-grade street-adjacent planter boxes are systems designed to take street runoff and/or runoff from sidewalks and incorporate bioretention processes to treat stormwater. These systems may or may not include underdrains.

Location and placement. Above-grade planters should be structurally separate from adjacent sidewalks to allow for future maintenance and structural stability per local department of public works' standards. At-grade planter systems can be installed adjacent to curbs within the frontage and/or furniture zones.

Guidelines. All planters should be designed to pond water for less than 48 hours after each storm. Flow-through planters designed to detain roof runoff can be integrated into a building's foundation walls, and may be either raised or at grade.

For at-grade planters, small localized depressions may be included in the curb opening to encourage flow into the planter. Following the inlet, a sump (depression) to capture sediment and debris may be integrated into the design to reduce sediment loadings.

Vegetated Buffer Strips

Vegetated buffer strips are sloping planted areas designed to treat and absorb sheet flow from adjacent impervious surfaces. These strips are not intended to detain or retain water, only to treat it as a flow-through feature. They should not receive concentrated flow from swales or other surface features, or concentrated flow from pipes.

Location and placement. Vegetated buffer strips are well-suited to treating runoff from roads and highways, small parking lots, and pervious surfaces. They may be commonly used on multi-way boulevards, park edge streets, or sidewalk furniture zones with sufficient space. Vegetated buffers can be situated so they serve as pre-treatment for another streetwater management feature, such as an infiltration BMP.

Guidelines. Buffer strips cannot treat large amounts of runoff; therefore, the maximum drainage width (with the direction of flow being towards the buffer) of the contributing drainage area should be 60 feet. In general, a buffer strip should be at least 15 feet wide in the direction of flow to provide the highest water quality treatment.

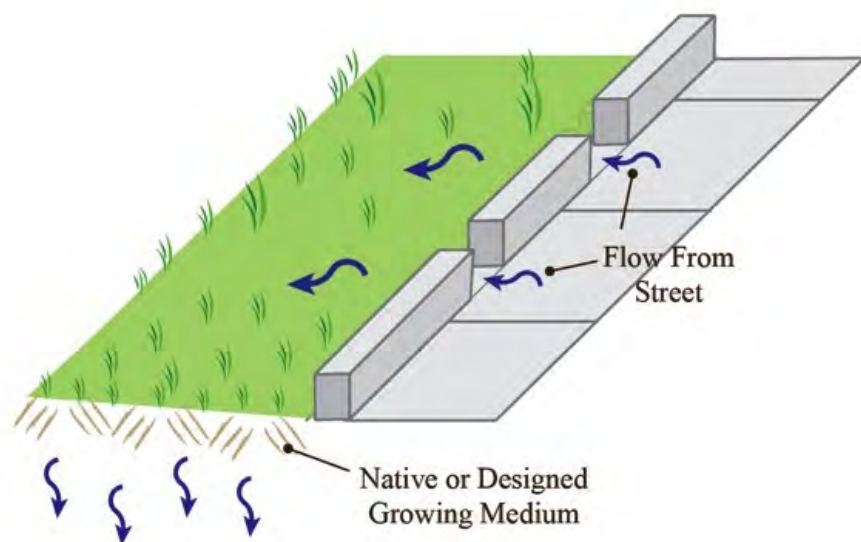

*Vegetated buffer strip detail
(Credit: Julia Campbell and Michele Weisbart)*

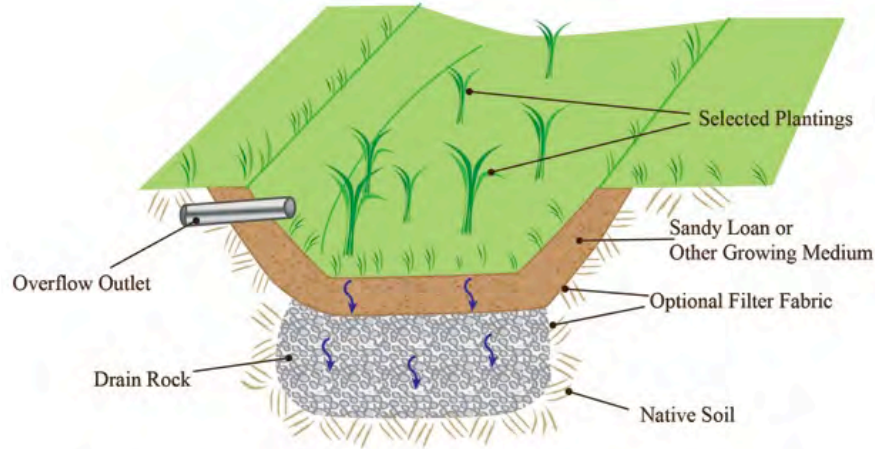

Rain garden detail (Credit: Julia Campbell and Michele Weisbart)

The top of the strip should be set 2 to 5 inches below the adjacent pavement or contributing drainage area, so that vegetation and sediment accumulation at the edge of the strip does not prevent runoff from entering.

Buffer strips should be sited on gentle slopes. Steep slopes in excess of 15 percent may trigger erosion during heavy rain events, thus eliminating water quality benefits.

Detention

Detention devices differ from retention in that they are designed and sized to hold a specific volume of water and then slowly release it over time. On the other hand, the bioretention BMPs described in the previous section are designed and sized based on flow—the rate of water passing through them. The objective of bioretention is to improve the quality of streetwater by promoting filtration and adsorption as water flows through vegetation and soil. Detention devices do not function as flow-through features, but rather the objective is to collect and contain water until it is removed by controlled release or infiltrated into the soil. Overflow outlets may be included to manage large storm events. Pollutants may be removed by vegetation and the topsoil layer as in bioretention BMPs so that streetwater is treated before it is infiltrated. Detention devices can greatly reduce the volume of runoff from streetscapes and for small storm events may completely eliminate runoff.

Rain Gardens

Rain gardens are vegetated depressions in the landscape. They have flat bottoms and gently sloping sides. Rain gardens can be similar in appearance to swales, but their footprints may be any shape. Rain gardens hold water on the surface, like a pond, and have overflow outlets. The detained water is infiltrated through the topsoil and subsurface drain rock unless the volume of water is so large that some must overflow. Rain gardens can reduce or eliminate off-site streetwater discharge while increasing on-site recharge.

Location and placement. Rain gardens may be placed where there is sufficient area in the landscape and where soils are suitable for infiltration. Rain gardens can be integrated with traffic calming measures installed along streets, such as medians, islands, circles, street ends, chicanes, and curb extensions. Rain gardens are often used at the terminus of swales in the landscape.

Guidelines. Native soils should have a minimum permeability rate of 0.5 inches per hour and at least 10 feet to the ground water table. Sites that have more than a 5 percent slope may require other stormwater management approaches or special engineering. The topsoil layer should be designed on a case-by-case basis and may often be a type of sandy loam. Subsurface drain rock will promote infiltration and should also be designed for each installation. Local public works departments may have additional guidelines for rain garden design.



*Rain garden in an urban landscape
(Credit: Kevin Robert Perry)*



*Rain garden: Portland, OR
(Credit: Brad Lancaster)*

The size and shape of rain gardens will vary in each case and the available area in the landscape may determine the maximum footprint. Because rain gardens are volume-based BMPs, their surface area and depth will be designed to achieve the desired detention volume. Overflow outlets should be below the lip of the rain garden and at a height consistent with the desired detention volume. Sides should be gently sloping to prevent erosion.

Rain gardens should be landscaped with deep-rooted grasses and other vegetation that can tolerate short periods of inundation, deposits of sediment, and periods of drought.



*Infiltration trench with perforated pipe during installation
(Credit: Neil Shapiro)*

Infiltration Trenches and Dry Wells

Infiltration trenches are linear, rock-filled features that promote infiltration by providing a high ratio of sub-surface void space in permeable soils. They provide on-site stormwater retention and may contribute to groundwater recharge. Infiltration trenches may accept streetwater from sheet flow, concentrated flow from a swale or other surface feature, or piped flow from a catch basin. Because they are not flow-through BMPs, infiltration trenches do not have outlets but may have overflow outlets for large storm events.

Dry wells are typically distinguished from infiltration trenches by being deeper than they are wide. They are usually circular, resembling a well, and are backfilled with the same materials as infiltration trenches. Dry wells typically accept concentrated flow from surface features or from pipes and do not have outlets.

Infiltration trenches and dry wells are typically designed to infiltrate all flow they receive. In large storm events, partial infiltration of runoff

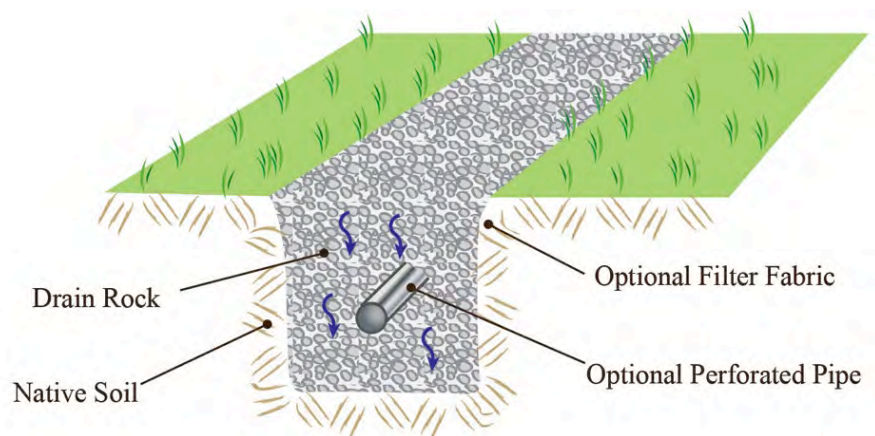

*Infiltration trench (Credit: Julia Campbell
and Michele Weisbart)*

can be achieved by providing an overflow outlet. In these systems, significant or even complete volume reduction is possible in smaller storm events. During large storm events, these systems may function as detention facilities and provide a limited amount of retention and infiltration.

Location and placement guidelines. Infiltration trenches and dry wells typically have small surface footprints so they are potentially some of the most flexible elements of landscape design. However, because they involve sub-surface excavation, these features may interfere with surrounding structures. Care needs to be taken to ensure that surrounding building foundations, pavement bases, and utilities are not damaged by infiltration features. Once structural soundness is ensured, infiltration features may be located under sidewalks and in sidewalk planting strips, curb extensions, roundabouts, and medians. When located in medians, they are most effective when the street is graded to drain to the median. Dry wells require less surface area than trenches and may be more feasible in densely developed areas.

Infiltration features should be sited on uncompacted soils with acceptable infiltration capacity. They are best used where soil and topography allow for moderate to good infiltration rates (0.5 inches per hour) and the depth to groundwater is at least 10 feet. Prior to design of any retention or infiltration system, proper soil investigation and percolation testing should be conducted to determine appropriate infiltration design rates. Any site with potential for previous underground contamination should be investigated. Infiltration trenches and dry wells can be designed as stand-alone systems when water quality is not a concern or may be combined in series with other streetwater tools.

Pre-treatment, design, and installation guidelines. Infiltration features do not treat streetwater and may become damaged by streetwater carrying high levels of sediment. In general, infiltration features should be designed in series with bioretention tools unless the infiltration features receive water from well-vegetated areas where sediment is not expected. Pre-treatment features should be designed to treat street runoff prior to discharging to infiltration features. Bioretention devices, sumps, and sedimentation basins are several pre-treatment tools effective at removing sediment.

Trenches and dry wells are typically backfilled with coarse drain

rock (coarse gravel) and may or may not be lined with filter fabric. Additional void space can be achieved by including materials such as perforated pipes, half pipes, or open blocks within the drain rock. The trench surface can be planted, covered with grating, covered with boardwalks, or simply remain as exposed drain rock. Local public works departments should be contacted for any local guidance on infiltration feature design.

The slope of the infiltration trench bottom should be designed to be level or with a maximum slope of 1 percent. Infiltration BMPs should be installed parallel to contours with maximum ground slopes of 20 percent and be located no closer than 5 feet to any building structure. Sub-soils should not be compacted. Drain rock and, if needed, filter fabric with an overflow drain should be designed for each installation.

Perforated pipes and piped inlets and outlets may be included in the design of infiltration trenches. Cleanouts should be installed at both ends of any piping, and at regular intervals in long sections of piping, to allow access to the system. Monitoring wells are recommended for both trenches and wells and can be combined with clean-outs. If included, the overflow inlet from the infiltration trench should be properly designed for anticipated flows.

Paving

Permeable Paving

Permeable paving is a system with the primary purpose of slowing or eliminating direct runoff by absorbing rainfall and allowing it to infiltrate into the soil. This BMP is impaired by sediment-laden run-on which diminishes its porosity. Care should be taken to avoid flows

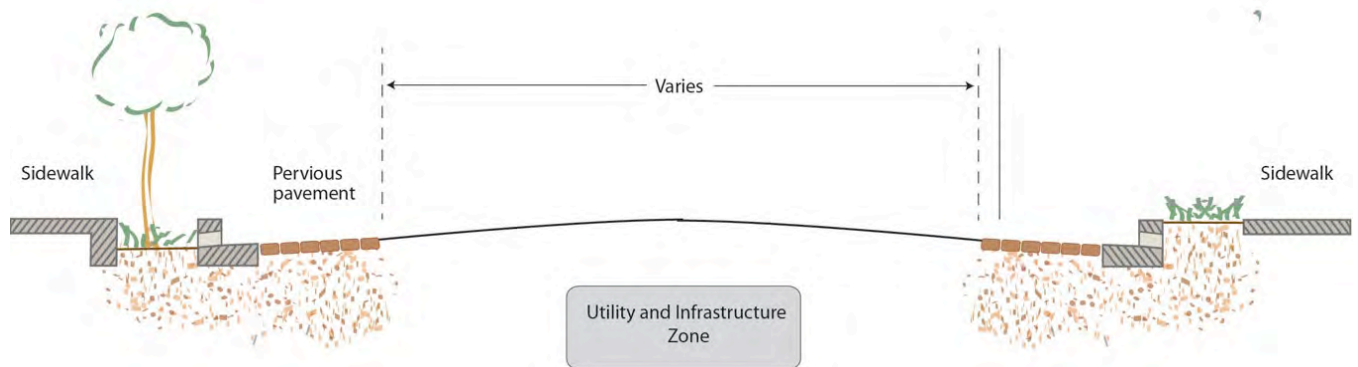

Street section elevation illustrating placement of permeable paving (Credit: Marty Bruinsma)



Permeable concrete after a rain event
(Credit: Neil Shapiro)



Permeable paving and a trench drain
in a parking area
(Credit: Stephanie Landregan)

from landscaped areas reaching permeable paving. In those cases, bioretention is a better choice for BMPs. Permeable paving is, in certain situations, an alternative to standard paving. Conventional paving is designed to move streetwater off-site quickly. Permeable paving, alternatively, accepts the water where it falls, minimizing the need for management facilities downstream.

Permeable paving

- Filters and cleans pollutants such as petroleum deposits on streets
- Reduces water volumes for existing overloaded pipe systems
- Decreases the cost of offsite or onsite downstream infrastructure

Location and placement guidelines. Conditions where permeable paving should be encouraged include

- Sites where there is limited space in the right-of-way for other BMPs
- Parking or emergency access lanes
- Furniture zones of sidewalks especially adjacent to tree wells

Conditions where permeable paving should be avoided include

- Where runoff is already being harvested from an impervious surface for direct use, such as irrigation of bioretention landscape areas
- Steep streets
- Large traffic volume or heavy load lanes
- Gas stations, car washes, auto repair, and other sites/sources of possible chemical contamination
- Areas with shallow groundwater
- Within 20 feet of sub-sidewalk basements
- Within 50 feet of domestic water wells

Material guidelines. When used as a road paving, pervious pavement that carries light traffic loads typically has a thick drain rock base material. Pavers should be concrete as opposed to brick or other light-duty materials. Other possible permeable paving materials include porous concrete and porous asphalt. These surfaces also have specific

base materials that detain infiltrated water and provide structure for the road surface. Base material depths should be specified based on design load and the soils report.

Plazas, emergency roads, and other areas of limited vehicular access can also be paved with permeable pavement. Paving materials for these areas may include open cell paver blocks filled with stones or grass and plastic cell systems. Base material specifications may vary depending on the product used, design load, and underlying soils.

When used for pedestrian paths, sidewalks, and shared-use paths, appropriate materials include those listed above as well as rubber pavers and decomposed granite or something similar (washed or pore-clogging fine material). Pedestrian paths may also use broken concrete pavers as long as ADA requirements are met. Paths should drain into adjoining landscapes and should be higher than adjoining landscapes to prevent run-on. Soil paths are not successful on slopes in excess of 4 percent. Any pervious materials used for sidewalks or paths should be very smooth for wheelchairs and bicyclists.

Design guidelines. Design considerations for permeable paving include

- The location, the slope and load-bearing capacity of the street, and the infiltration rate of the soil
- The amount of storage capacity of the base course
- The traffic volume and load from heavy vehicles
- The design storm volume calculations and the quality of water
- Drain rock, filter fabrics, and other subsurface materials
- Installation procedures including excavation

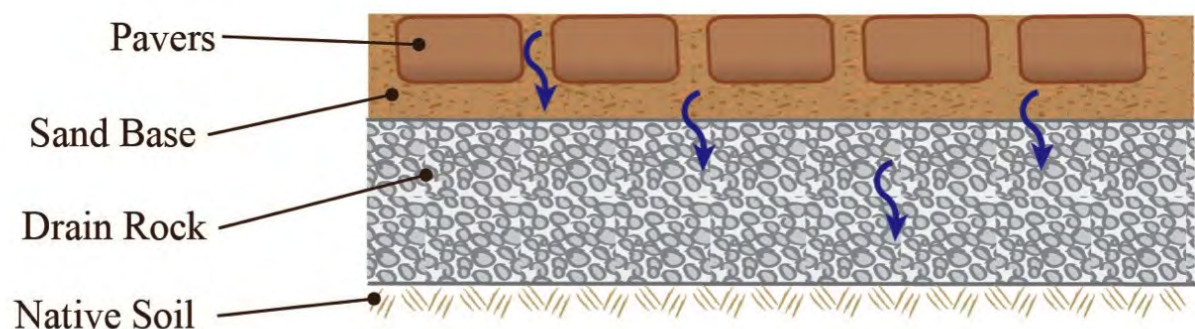

Pervious pavement detail (Credit: Julia Campbell and Michele Weisbart)

A soil or geotechnical report should be conducted to provide information about the permeability and load-bearing capacity of the soil. Infiltration rate and load capacity are key factors in the functionality of this BMP. Permeable paving generally does not have the same load-bearing capacity as conventional paving, so this BMP may have limited applications depending on the underlying soil strength and paving use. Permeable paving should not be used in general traffic lanes due to the possible variety of vehicles weights and heavy volumes of traffic.

The soil report should also provide the depth of the water table to determine if permeable pavers are an appropriate application for the site. Pervious pavement typically requires a 4-foot or more separation from the water table or bedrock to properly infiltrate streetwater. Pervious pavement is not recommended over new or compacted fill.

Because permeable pavement is damaged by sediment deposits, it should be carefully placed in the landscape so as to avoid run-on, especially from sediment-laden sources such as landscaped areas.

Pavement used for sidewalks and pedestrian paths should be ADA compliant, especially smooth, and not exceed a 2 percent slope or have gaps wider than 0.25 inches. In general, tripping hazards should be avoided.

Maintenance and installation guidelines. Proper construction and installation of permeable pavement is vital to its success. To ensure that the paving system functions properly, sub-base preparation and stormwater pollution prevention measures should be performed appropriately during installation.

Construction considerations include

- Scarifying soils so that they remain porous
- Avoiding compaction of soils
- Preventing run-on and sedimentation during construction

Maintenance of permeable pavement systems is essential to their continued functionality. Regular vacuuming and street sweeping should be performed to remove sediment from the pavement surface. The bedding and base material should be tested to ensure sufficient infiltration rates on a regular basis. Additionally, base material may need to be removed and replaced every several years based upon the material manufacturer's specifications.

Delivery and Conveyance

Water conveyance measures in the hardscape may support the treatment BMPs outlined above. By daylighting streetwater flow, these measures draw attention to water movement and can in turn highlight bioretention and detention BMPs. Delivery and conveyance measures do not treat streetwater for quality and do not reduce water volume. They are therefore only recommended as supporting infrastructure, a preferable alternative to traditional piped flow.

Channels, Runnels, Trench Drains, and Constructed Swales

Channels, runnels, trench drains, and constructed swales are conventional methods of conveying moderate amounts of streetwater from buildings and impervious surfaces to other drainage collection systems, streets, or planters. They are hardscape features constructed from impermeable materials.

Typically, these structures work well where there is a need for water redirection and space is limited. These hardscape methods may serve to move streetwater from the street to landscaped areas. Channels and constructed swales are not used for stormwater treatment but serve as daylighted, visible conveyance features in lieu of closed pipe systems. They provide opportunities to acknowledge natural drainage processes with artistic design features along the drainage path.



*Decorative runnel and fountain
(Credit: Stephanie Landregan)*



*Trench drain in hardscape
(Credit: Stephanie Landregan)*

A variety of materials can be used for channels, runnels, and constructed swales: stone, brick, pebbles, pavers, and concrete. Rock swales can be created by arranging stones loosely and mortaring them in place. When a closed top is required, grates can be constructed; proprietary products in standard sizes are readily available. Decorative grates are aesthetic and help illustrate water flow processes.

Because these structures are gravity fed, they require slopes to function properly. On slopes greater than 6 percent, check dams or other velocity reduction devices should be provided.

These conveyance features may direct sheet flow to bioretention or infiltration features or simply serve as an alternative to piped flow in conventional drainage systems. Dimensions should be determined based on the design storm.

Channels have vertical sides and provide a drainage path to a downstream streetwater management feature. Channels vary in depth depending on the amount of flow they are designed to carry, have a sloped bottom, and can be covered or open. In some cases, channels can be constructed with pervious bottoms. Channels can be placed in plazas, driveways, and other hardscapes where conveyance is needed. Channels may be used in some situations where swales or pipes would be too costly or impossible due to site constraints. In broad landscape contexts, channels can be large and constructed to carry large volumes of water.



*Constructed swale with drain
(Credit: Stephanie Landregan)*

Runnels are shallower than channels, typically only a couple of inches deep, and are designed to carry small flows of streetwater. Runnels may have an open top but must be covered if they cross pedestrian walkways. Most often runnels are used to convey runoff from hardscapes to adjacent streetwater treatment landscapes. Runnels may be very useful in pedestrian hardscape areas where artistic construction is highly visible. The location and design of runnels should be carefully selected so that they do not pose tripping hazards.

Trench drains are a type of conveyance system similar to runnels. Trench drains differ from runnels in that they are usually smaller and have a grated top. They also have solid sides and bottoms. Trench drains are available in standard sizes and dimensions from a variety of manufacturers.

Constructed swales are similar to the swales discussed earlier but are constructed from impervious materials. They typically are long narrow depressions used to convey water. The size of a swale should be determined by the design storm and landscape features.

Access, design, and maintenance guidelines. All conveyance structures, both open and covered, need to meet accessibility guidelines when in the path of travel. Boardwalks can cover large swales, or decorative grates can be used over smaller widths.

Channels, runnels, and constructed swales should be designed to meet the local agency design storm requirements. Overflow features may be required in some areas and should drain to the nearest gutter or other drainage feature, always draining away from adjacent properties. These features should be designed to allow debris to move through them and account for stoppages that could limit the drainage capacity.

Maintaining a clear conduit is essential for the proper functioning of conveyance structures. These features should be cleaned before the rainy season and checked before and after storm events. Trash, cigarette butts, soil sediment, and leaf litter all can contribute to failure and decrease the function of these features.

Storm Drain Inlet Protections: Retrofitting Existing Storm Drains

Existing storm drain systems may be retrofitted to improve streetwater quality without costly capital improvements. The BMPs described below can be used with existing conventional piped storm drain systems to address water quality but not water volume concerns. The measures described below are designed to prevent particulates, debris, metals, and petroleum-based materials conveyed by streetwater from entering the storm drain system. All storm drain protection units should have an overflow system that allows the storm drain to remain functional if the filtration system becomes clogged during rainstorms.

Typical maintenance of catch basins includes scheduled trash removal if a screen or other debris capturing device is used. Street sweeping should be performed by vacuum sweepers with occasional weed and large debris removal. Maintenance should include keeping a log of the amount of sediment collected and the data of removal. Some cities have incorporated the use of GIS systems to track sediment collection and to optimize future catch basin cleaning efforts. Bulb-outs should be designed with two return curves with a radius of over 10 feet to allow street sweepers to clean the corners.

All inlet tools located in the pedestrian access route should conform to ADA requirements.

Storm Drain Inlet Screens: Placement and Guidelines

Inlet screens are designed to prevent large litter and trash from entering the storm drain system while allowing smaller particles to pass through. The screens function as the first preventive measure in removing pollutants from the storm water system. Storm drain inlet screens can be designed and fabricated on an as-needed basis; proprietary screens are readily available for standard size inlets.

Inlet screens are external units mounted on existing curb side storm drain catch basins. The unit captures bigger particles and allows the



*Curb inlet grate catching debris
(Credit: Andre Haghverdian)*

storm water and small particles to pass through. The screen can be mounted on hinges to create a bypass if the screen is clogged during a storm.

A wide range of storm drain inlet screens is available. The city's street sweeping department should be consulted to ensure compliance with local specifications and to schedule regular maintenance. Annual inspection of the screen is recommended to ensure functionality.

Storm Drain Inlet Protection: Placement and Guidelines

The inlet protection should be designed to protect curbside catch basins or inlets within the traveled way. Inlet inserts contain filter cartridges that can be easily replaced.

The inlet protection can be installed on the existing wall of the catch basin. It can be placed on the curb side wall of catch basins so that during storm events water can overflow around the unit.

Inlet inserts should be sized to capture all debris and should therefore be selected to match the specific size and shape of each catch basin and inlet. Maintenance should be taken into account—systems with lower maintenance requirements are preferred.

Storm Drain Pipe Filter: Placement and Guidelines

The storm drain outlet pipe protection or filter is designed to be installed on an existing outlet pipe or at the bottom of an existing catch basin with an overflow. This filter removes debris, particulates, and other pollutants from streetwater as it leaves the storm drain system. This BMP is less desirable than a protection system that prevents debris from entering the storm drain system because the system may become clogged with debris.

Outlet pipe filters can be placed on existing curbside catch basins and flush grate openings. Regular maintenance is required and inspection should be performed rigorously. Because this filter is located at the outlet of a storm drain system, clogging with debris is not as apparent as with filters at street level. This BMP may be used as a supplemental filter with an inlet screen or inlet insert unit.

URBAN FORESTRY

The urban forest includes all trees, shrubs, and other understory plantings on both public and private lands. Street trees and landscaping are essential parts of the urban forest, as they contribute positively to the urban environment—to climate control, stormwater collection, and the comfort and safety of people who live or travel along the street. A street lined with trees and other plantings looks and feels narrower and more enclosed, which encourages drivers to slow down and to pay more attention to their surroundings. Trees provide a physical and a psychological barrier between pedestrians and motorized traffic, increasing safety as well as making walking more enjoyable.

A healthy urban forest is also a powerful streetwater management tool. Leaves and branches catch and slow rain as it falls, helping it to soak into the ground. The plants themselves take up and store large

quantities of water that would otherwise contribute to surface runoff. Part of this moisture is then returned to the air through evaporation to further cool the city.

As an important element along sidewalks, street trees must be provided with conditions that allow them to thrive, including adequate uncompacted soil, water, and air. This section provides guidance for appropriate conditions and selecting, planting, and caring for street trees, as well as for other landscaping along streets.



*Appropriate local street trees
(Credit: Dan Burden)*

Street Trees

Goals and Benefits of Street Trees

The goal of adding street trees is to increase the canopy cover of the street, the percentage of its surface either covered by or shaded by vegetation, not simply to increase the overall number of trees. The selection, placement, and management of all elements in the street should enhance the longevity of a city's street trees and healthy, mature plantings should be retained and protected whenever possible.

A large tree will yield \$48 to \$62 in average annual net benefits over 40 years with costs factored in (McPherson, G. et al, "Tree Guidelines for San Joaquin Valley Communities," Western Center for Urban Forest Research and Education, USDA Forest Service, 1999). Adding street trees

- Creates shade to lower temperatures in a city, reduces energy use, and makes the street a more pleasant place in which to walk and spend time
- Slows and captures rainwater, helping it soak into the ground to restore local hydrologic functions and aquifers
- Improves air quality by cooling air, producing oxygen, and absorbing and storing carbon in woody plant tissues
- Increases property values and sales revenues for existing businesses
- Enhances local neighborhood and cultural identity through specific plant forms and materials, the act of planting and sharing food crops, or by creating sheltering spaces for social interaction
- Enhances safety and personal security on a street by calming traffic and by fostering a denser and more consistent human presence, also referred to as eyes on the street
- Provides cover, food, and nesting sites for indigenous wildlife as well as facilitates habitat connectivity



Street trees (Credit: Patricia Smith)

Principles for Street Trees

The following principles influence the selection of street trees and landscaping design:

- ***Seek out and reclaim space for trees.*** Streets have a surprising number of residual or left-over spaces between areas required for travel lanes and parking, once they are examined from this perspective. Traffic circles, medians, channelization islands, and curb extensions can provide space for trees and landscaping.
- ***Create optimum conditions for growth.*** Space for roots and above ground growth is the main constraint to the urban forest achieving its highest potential. Typically a 6 to 8-foot wide, continuous sidewalk furniture zone must be provided, with uncompacted soil to a minimum of a 3-foot depth. If space for trees is constrained, provisions should be made to connect these smaller areas below the surface to form larger effective areas for the movement of air, root systems, and water through the soil.
- ***Select the right tree for the space.*** In choosing a street tree, consider what canopy, form, and height will maximize benefits over the course of its life. Provide necessary clearances below overhead high-intensity electrical transmission lines and prevent limbs from overhanging potentially sensitive structures such as flat roofs. In commercial areas where the visibility of façade-mounted signs is a concern, choose species whose mature canopy allows for visibility, with the lowest branches at a height of 12 to 14 feet or more above the ground. Select trees with non-aggressive root systems to avoid damaging paving and sidewalks.
- ***Start with good nursery stock and train it well.*** When installing plant material, choose plants that have complete single leaders and are in good “form,” and check that boxed trees are not root bound. Proper watering and pruning every three to four years will allow trees to mature and thrive for many years of service.

- *Do not subject plants to concentrated levels of pollutants.* Trees and other plants should be integrated within streetwater management practices whenever possible, but filtering of pollutants from “first flush” rain falls and street runoff will extend the life of trees and prevent toxic buildup of street pollutants in tree wells.

Guidelines

Climate and Soil

Selecting trees that are adapted to a site’s climate and local rain cycles can create a more sustainable urban forest. The urban environment is harsh for many plants. Often plants native to an area are best adapted to that area’s climate. Select plants that can tolerate the environmental elements, such as radiant heat from the sidewalk or street surface or 50 to 60 mph winds from passing traffic.

Urban soils have become highly compacted through construction activities and the passage of vehicle and even foot traffic. Compaction reduces the soil’s capacity to hold and absorb water. Plants need healthy soil, air, and water to thrive.

To add biomass and canopy cover, both the volume and quality of soil at planting sites should be increased. But even when the soil in confined tree pits has been amended, something of a planter-like condition exists at the bottom and sides where the prepared area meets the surrounding compacted soils. Covering the soil surface with mulch can help, as the added shade, cooling, and retained moisture help support the biological activities close to the soil’s surface. These activities open and help keep open the pore structure of the soil and cushion the impact of foot traffic. The process works better if the mulch material is organic rather than stone. Those with limited resources for soil preparation should invest in an extensive covering of mulch.

The generalized soil types map for a city can be used as a starting point when planning projects, but then the basic soil classifications should be identified on-site, especially when confronted by planting sites at the extreme ends of the spectrum: very fast-draining, nutrient-poor sands and dense, often nutrient-rich but oxygen-starved poorly drained clays.

Planting Sites

Traditionally, trees have been squeezed into whatever limited space is easily found, but this does not work well for either the tree or the street. The following guidelines provide recommended planting areas:

- Establish and maintain 6 to 8-foot wide sidewalk furniture zones where possible. Many large trees need up to 12 feet in width, and are not suitable for placement in narrower furniture zones. In residential areas, sidewalk furniture zones within the root zone should be unpaved and planted/surfaced with low groundcover, mulch, or stabilized decomposed granite where these can be maintained. Where maintenance of such extensive sidewalk furniture zones is not feasible, provide 12-foot long tree wells with true permeable pavers (standard interlocking pavers are not permeable).
- If the above conditions are not feasible, provide for the tree's root system an adequate volume of uncompacted soil or structural or gap-graded soil (angular rock with soil-filled gaps) to a depth of 3 feet under the entire sidewalk (in the furniture, frontage, and pedestrian sidewalk zones).
- Spacing between trees will vary with species and site conditions. The spacing should be 10 percent less than the mature canopy spread. Closer spacing of large canopy trees is encouraged to create a lacing of canopy, as trees in groups or groves can create a more favorable microclimate for tree growth than is experienced by isolated trees exposed to heat and desiccation from all sides. On residential streets where lots are 40 or 50 feet wide, plant one tree minimum per lot between driveways. Where constraints prevent an even spacing of trees, it is preferable to place a tree slightly off the desired rhythm than to leave a gap in the pattern.
- Planting sites should be graded, but not overly compact, so that the soil surface slopes downward toward the center, forming a shallow swale to collect water. The crown of the tree should remain 2 inches above finished grade and not be in the center of a swale, but off to the side. The finished soil elevation after planting is held below that of the surrounding paving so 2 to 3 inches of mulch can be added. The mulch layer must be replenished as needed to maintain a nearly continuous level

surface adjacent to paving.

- Generally tree grates and guards are best used along streets with heavy pedestrian traffic. Along streets without heavy foot traffic and in less urban environments, use mulch in lieu of tree grates.

Species Selection

- Select trees with non-aggressive root systems to avoid damaging paving and sidewalks.
- In general, street trees should be species that will achieve a height and spread of 50 feet on residential streets and 40 feet on commercial streets within 10 years of planting to provide reasonable benefits. Typically, trees on commercial streets will not achieve the same scale as they will on residential streets where greater effective root zone volumes may be achieved. On commercial streets with existing multi-story buildings and narrow sidewalks, select trees with a narrower canopy than can be accommodated on the limited sidewalk width.
- Cities should establish a list of recommended tree species for use in the public street rights-of-way. In the Los Angeles basin, drought-tolerant native trees with large canopies include Coast Live Oaks (*Quercus agrifolia*) and Sycamores (*Platanus racemosa*). (Note that dry weather runoff should not be directed to oaks and other trees that are not tolerant of dry season irrigation.) On commercial streets with ground-floor retail, deciduous trees with a strong central leader, such as Ginkos and London Planes, are desirable as they grow rapidly above the ground floor business signs. A city's list of recommended tree species should specify minimum planting site widths for each and which trees may be planted below utility lines. Where there are overhead power lines that are less than 50 feet above grade, braided insulated electrical wire should be used so that trees do not have to be pruned to avoid the electrical lines. If braided insulated electrical wire cannot be provided, appropriate trees that will not grow tall enough to reach the power lines should be specified and planted.
- Trees that are part of streetwater management practices must be species that respond well to the extremes of periodic inundation and dry conditions found in water catchment areas.



*Traditional landscaping, requiring irrigation, along a residential parkway in Southern California
(Credit: Patricia Smith)*



*More sustainable landscaping in Southern California
(Credit: Patricia Smith)*



*Landscaped parkway along a commercial street
(Credit: Patricia Smith)*

Design of all planting areas should include provisions for improved streetwater detention and infiltration.

- Consistent use of a single species helps reinforce the character of a street or district, but a diversity of species may help the urban canopy resist disease or insect infestations. New plantings added to streets with existing trees should be selected with the aim of meeting the same watering requirements and creating visual harmony with existing trees and plantings. Native species should be considered for inclusion whenever possible, but consideration should be first given to a species' adaptability to urban conditions.
- Consider evergreen species where it is desirable to maintain foliage through the winter months, such as to slow streetwater through the rainy season.
- Consider deciduous species where their ability to allow sunlight to penetrate into otherwise shaded areas (such as south facing windows of adjoining buildings) during the winter months will be a plus.

Tree Spacing and Other Considerations

- See Chapter 4, "Traveled Way Design," for an understanding of how to take intersection sight distance into account when designing intersections. Many jurisdictions have tree spacing requirements at intersections, which typically vary from 30 to 45 feet, to provide visibility at corners. But as discussed in Chapter 4, this distance can often be reduced with no compromise in safety in slow speed environments.
- Most jurisdictions have spacing requirements between trees and street lights (typically about 30 feet high), which typically vary from

10 to 20 feet. The smaller setback provides greater flexibility in tree spacing and allows for a more complete tree canopy.

- Pedestrian lights, which are about 12 feet tall, generally do not conflict with the tree canopy, so spacing is less rigid. Some jurisdictions still require wide clearance for their convenience in maintaining the lights, but this wide spacing greatly reduces tree canopy and is therefore discouraged. Spacing of 10 feet away from trees is generally adequate.
- An 8-foot minimum clearance must be maintained between accessible parking spaces and trees.
- Trees may be planted as close as 6 feet from bus shelters, where they provide welcoming shade at transit stops.
- Adequate clear space should be provided between trees and awnings, canopies, balconies, and signs so they will not come into conflict through normal growth or require excessive pruning to remediate such conflicts.
- Trees may be planted in medians that are 4 feet or wider, but must have an adequate clear height between the surface of the median and the lowest branches so that pedestrians can be seen. Where trees hang over the street, the clear height should be 14 feet.

Understory Landscaping

Understory landscaping refers to landscape elements beneath the tree canopy in areas within the public right-of-way not required for vehicular or pedestrian movement, including

- Medians
- Curb extensions
- Furniture and frontage zones

Benefits of Understory Landscaping

- Complements and supports street trees, in particular by providing uncompacted, permeable areas that accommodate roots and provide air, water, and nutrients

- Reduces impervious area and surface runoff
- Treats stormwater, improving water quality
- Provides infiltration and groundwater recharge
- Provides habitat
- Reduces the perceived width of the street by breaking up wide expanses of paving, particularly when the understory is in medians and sidewalk furniture zones
- Contributes to traffic calming
- Provides a buffer between the walkway zone and the street, contributing to pedestrian comfort
- Improves the curb appeal of properties along the street, potentially increasing their value
- Enhances the visual quality of the community

Principles

- Trees take precedence: the understory landscape should support them. It should not compete with them.
- Only pave where necessary: keep as much of the right-of-way unpaved and planted as possible to maximize benefits
- Design understory areas to infiltrate water
- The entire understory area does not have to be covered with plants—composted mulch is a good groundcover (top of mulch should be below adjoining hardscape so that runoff will flow into planting areas).
- Make the understory sustainable: use drought-tolerant plants
- Replenish the soil with compost
- Design the understory to contribute to the sense of place

Guidelines

Soil

Provide good quality, uncompacted, permeable soil. Soil analyses should address the concentration of elements that may affect plant growth, such as pH, salinity, infiltration rate, etc. Remove and replace or amend soil as needed. Good preparation saves money in the long run because it reduces the need to replace plants, lowers water consumption, and reduces fertilizer applications.

Design

Generally, understory landscaped areas should be as wide as possible where there are trees: when feasible, at least 6 to 9 feet wide for parkways and 8 to 12 feet wide for medians. However, many existing parkways and medians are less wide. Narrower parkways can support understory plants and some tree species. A path or multiple paths should be added as needed across a parkway as a means of access from the curb to the sidewalk. For example, where there are striped curbside parking spaces, a path across the parkway should be provided at every one or two parking spaces.

Plant with species that

- Do not require mowing more frequently than once every few months
- Are drought tolerant and can survive with minimal irrigation upon establishment
- Do not exceed a height of 2 feet within 5 feet of a driveway/curb cut and within 20 feet of a crosswalk, and, excluding trees, 3 feet elsewhere
- Do not have thorns or sharp edges adjacent to any walkway or curb
- Are located at least 4 feet from any tree trunk



Walking path across the parkway provides access from parked cars to sidewalk (Credit: Patricia Smith)

STREET FURNITURE

Street furnishings in the street environment add vitality to the pedestrian experience and recognize the importance of the pedestrian to the fabric of a vibrant urban environment. Street furnishings encourage use of the street by pedestrians and provide a more comfortable environment for non-motorized travel. They provide a functional service to the user and provide uniformity to the urban design. Street furnishings include benches and seating, bollards, flower stands, kiosks, news racks, public art, sidewalk restrooms, signs, refuse receptacles, parking meters, and other elements.

Street furnishings achieve improved vitality in many ways:

- They make walking, bicycling, and public transit more inviting.
- They improve the street economy and common city prosperity.
- They enhance public space and create a place for social interaction.

Placement of street furnishings should be provided

- At concentrations of pedestrian activity (nodes, gathering areas)
- On streets with pedestrian-oriented destinations. Pedestrians may gather or linger and enjoy the public space.
- Site furnishing placement should follow these criteria :
 - Street furnishings are secondary to the layout of street trees and light standards as street trees and light standards develop a street rhythm and pattern. Site furnishing should be placed in relation to these elements sensitive to the vehicular flow and pedestrian use of these elements. Careful consideration to the placement provides ease of recognition and use.
 - In addition to the guidelines provided for each element, placement should adhere to the minimum spacing. Site furnishing installed within the appropriate zone will be spaced not less than as shown in Table 11.2.

Table 11.2 Site Furnishing Minimum Setbacks

Location	Setback
Face of Curb	18"
Driveway	2'
Wheelchair Ramp	2'
Ramp Landing	4'
Fire Hydrant	5'
Stand Pipe	2'
Transit Shelter	4'

- All site furnishing must be accessible per Public Rights-of-Way Accessibility Guidelines (PROWAG) and other city regulations.
- Cities should strive to include sustainable materials for street furnishings.

Benches and Seating

Public seating provides a comfortable, utilitarian, and active environment where people can rest, socialize, or read in a public space. The proper placement of a bench is a simple gesture creating a sense of place for the immediate area.



Street bench (Credit: Sky Yim)

Location

Seating arrangements should be located and configured according to the following guidelines:

- Seating should be located in a shaded area under trees.
- Seating should be oriented toward points of interest; this can be the adjacent building, an open space, or the street itself if it's lively. Where sidewalk width permits, seating can also be oriented perpendicular to the curb.
- Informal seating opportunities, incorporated into the adjacent building architecture, may be used as an alternative to free-standing benches. Low planter walls can be used as informal seating areas.

Design

Benches and seating should be made of durable high-quality materials. The seating design should complement and visually reinforce the design of the streetscape.

Seating opportunities should be integrated with other streetscape elements.



Bollards
(Credit: Sky Yim)

Bollards

Bollards are primarily safety elements to separate pedestrians or other non-motorized traffic from vehicles. Thoughtful design and/or location of bollards can add interest, visually strengthen street character, and define pedestrian spaces.

Location

Bollards are used to prevent vehicle access on sidewalks, or on other areas closed to motor vehicles. Removable bollards should be placed at entrances to permanent or temporary street closures.

Design

Bollards range in size from 4 to 10 inches in diameter. Bollards should have articulated sides and tops to provide distinct design details. The details should be coordinated with other street elements of similar architectural character.

Removable bollards should be designed with a sturdy pipe projecting from the bottom of the exposed bollard. Removable bollards should appear permanent. Electrically controlled mechanisms retract the bollard into a void below the surrounding finish surface. This allows emergency vehicle access to closed streets.



Street vendor stand
(Credit: Sky Yim)

Street Vendor Stands

Street vendor stands, such as flower, magazine, and food vendor stands, rely on regular pedestrian traffic to sustain their business. To maximize efficiency, the stands operate during daytime work hours and cater to those commuting to/from employment areas. In areas with a vibrant evening environment, stands may have evening hours to benefit from the extended period of exposure to pedestrian traffic.

Location

Generally, street vendor stands should either be located outside the street right-of-way or in the sidewalk, furniture, or frontage zones.

Design

The design of the street vendor stands should have details and features coordinated with other street elements. These details should be of a similar architectural character. The stands should allow a minimum of 6 feet of clear pedestrian passage between the edge of the display area and other elements.



Informational kiosk
(Credit: Paul Zykofsky)

Informational Kiosks

Kiosks in public areas provide valuable information, such as maps, bulletin boards, and community announcements. Kiosks can often be combined with gateway signs and are an attractive and useful street feature.

Location

Kiosks may be located in any of the following areas:

- The sidewalk, furniture, or frontage zones
- Curb extensions
- Where parking is not allowed
- Close to, but not within transit stops
- Kiosks should not block scenic views.

Design

Kiosks should be designed to the following guidelines:

- Kiosks should include bulletin boards or an enclosed case for display of information.
- As a gateway element, the kiosk should include the neighborhood, commercial district, street, or park name; a map; or other information.
- Kiosks should have details and features coordinated with other street elements and should have a similar architectural character.

News Racks

Location

News rack placement is subject to municipal guidelines. In addition, the following guidelines should be considered:

- News racks located within the furniture or frontage zones should not reduce the minimum width of the sidewalk pedestrian zone with news rack doors open.
- News racks should be placed no closer than 2 feet from adjacent street signs and 4 feet from bike racks.



News rack (Credit: Ryan Snyder)

Design

News racks should visually blend with their surroundings and complement the architectural character. Multiple news racks should be consolidated into a standard decorative stand.

Parking Meters

Parking meters can be either traditional single-space meters or consolidated multi-space meters (parking stations).

Location

Parking meters should be placed in the sidewalk furniture zone. Single-space meters should be placed at the front end of the individual stalls.

Multi-space meters are preferred over single-space meters. Multi-space meters should be placed every 8 to 10 parking spaces and spaced approximately 150 to 200 feet apart. Signs should clearly direct patrons to the meter. The signs should be spaced at approximately 100 feet on-center.

Design

Municipalities should encourage the conversion of single-space meters to multi-space units to reduce visual clutter from the urban landscape. The multi-space units should be selected to minimize their impact on the pedestrian zone.



Street signs (Credit: Sky Yim)

Signs

Streetscape signs provide information specific to direction, destination, or location. The sign plans should be developed individually for each neighborhood or district. Streetscape signs are most appropriate for downtown, commercial, or tourist-oriented locations or around large institutions. Streetscape signs include parking, directional, and wayfinding signs.

Location

Streetscape signs should be kept to a minimum and placed strategically. They should align with the existing street furnishings and be placed in the sidewalk furniture zone.

Design

The sign design should be attractively clean and simple and complement the architectural character of other street furnishings.



Refuse receptacle (Credit: Ryan Snyder)

Refuse Receptacles

Refuse receptacles should accept both trash and recyclables. Where there is a demand, different receptacles should be provided for different recyclable materials.

Location

Refuse receptacles should be located

- Near high activity generators such as major civic and commercial destinations
- At transit stops
- Near street corners but outside of the sidewalk pedestrian zone

There should be a maximum of one refuse receptacle every 200 feet along commercial streets and a maximum of four refuse receptacles at an intersection (one per corner).

Public Art

On a large scale, public art can unify a district with a theme or identify a neighborhood gateway. At a pedestrian scale, public art adds visual interest to the street experience.



Public art (Credit: Sky Yim)

Location

Public art can be situated in a variety of areas and locations, including streets, public spaces with concentrations of pedestrians, or areas of little pedestrian traffic, to create a unique space for discovery.

Design

Public art should be considered during the planning and design phase of development to more closely integrate art with other streetscape elements, taking into account the following:

- Public art is a pedestrian amenity and should be presented in an area suited for pedestrian viewing. The piece should be placed as a focal element in a park or plaza, or situated along a pedestrian path and discovered by the traveler.
- Public art can be incorporated into standard street elements (light standards, benches, trash receptacles, utility boxes).
- Public art can provide information (maps, signs) or educational information (history, culture). All installations do not need to have an educational mission; art can be playful.

- Public art should be accessible to persons with disabilities and placement must not compromise the sidewalk pedestrian zone.

Sidewalk Dining

Outdoor café and restaurant seating adjacent to the sidewalk activates the street environment and encourages economic development.

Location

Tables and chairs are to be placed on the sidewalk directly at the front of the restaurant and allowed in the frontage zone or furniture zone of the sidewalk where sufficient width is available.

Design

Placement of tables and chairs must include diverters (barriers) at the end of the dining area to guide pedestrians away from the accepted area of sidewalk. Since the public purpose of allowing restaurants to have dining on the sidewalk is to stimulate activity on the street, municipalities should prohibit restaurants from fully enclosing the dining area.



*Outdoor café seating: Utrecht,
Holland (Credit: Ryan Snyder)*

Other Streetscape Features

Other features that enhance the pedestrian experience include clocks, towers, and fountains, which strengthen the sense of place and invite pedestrians to come enjoy.



Other example streetscape fixtures (Credit: Ryan Snyder)

UTILITIES

The location of underground and aboveground utilities must be considered when planning new landscaped areas in the right-of-way. Each jurisdiction should establish guidelines to organize and standardize utility location and to minimize conflicts between landscaping and utilities based on input from all affected departments and agencies.

The majority of underground utilities, including sanitary sewers and storm drains, and water, gas, and electrical mains, are typically located under the roadway. Sanitary sewers are often in the center of the street directly under the potential location of a landscaped median. They are usually relatively deep. In general, if they have at least 4 or 5 feet of cover, they should not be affected by the introduction of a landscaped median. The other utilities within the roadway are typically located closer to the curbs.

Telecommunications, street lighting conduit, traffic signal conduit, and fiber optic conduit are often located under the sidewalk. Lateral lines extend from the utility mains in the public rights-of-way to serve adjacent properties.

Benefits of well-organized utility design/placement include

- Reduced clutter in the streetscape
- Increased opportunity for planting areas and for soil volume to support tree growth and stormwater infiltration
- Reduced maintenance conflicts
- Improved pedestrian safety and visual quality

Guidelines

Location



*Artfully painted utility box
(Credit: Sky Yim)*

- Utilities should be placed to minimize disruption to pedestrian travel and to avoid ideal locations for directing streetwater, planting trees and other vegetation, and siting street furniture, while maintaining necessary access to the utilities for maintenance and emergencies.
- Utilities within 10 feet of where a landscaped median may be located should have at least 5 feet of cover.
- Utility main lines that run laterally under the sidewalk should be located in a predetermined zone to minimize conflicts with tree roots and planting areas. The ideal location to minimize conflicts with trees would be under the pedestrian or frontage zones, although the more practical location is often under the furniture zone. Stacking dry utilities (telephone, CATV, electric, etc.) in the pedestrian or frontage zones will further reduce conflicts with the landscaped area.

Roadway/Parking Lane

- Large utility vaults and conduits running the length of a city block may be located in the roadway or parking lane where access requirements allow. Vaults in the parking lane may be located in short-term parking zones or in front of driveways to facilitate access. Each jurisdiction typically has specific design standards for vaults and utilities based on expected use and vehicle type. They can also be placed in midblock curb extensions.

Furniture Zone

- Small utility vaults, such as residential water vaults, residential water meters, gas valves, gas vaults, or street lighting access, should be located in the sidewalk furniture zone at the back of the curb wherever possible to minimize conflicts with existing or potential tree locations and landscaped areas. Vaults should be aligned or clustered wherever possible.
- Generally, utility boxes are sited in the direction of the pipe. Utility boxes that are parallel with the curb should be located in the sidewalk furniture zone when possible. Vaults perpendicular to the curb should be located between existing or potential street trees or sidewalk landscape locations (for example, in walkways through the sidewalk furniture zone to parked cars.)
- Utility laterals should not run directly under landscaped areas in the furniture zone, but instead under driveways and walkways wherever possible.

Sidewalk Pedestrian Zone

- Flush utility vaults and conduits running the length of the city block may be located in the pedestrian zone. Vaults in the pedestrian zone should have slip-resistant covers.
- Large flush utility vaults should be placed at least 3 feet from the building and 4 feet from the curb where sidewalk widths allow.
- Surface-mounted utilities should not be located in the pedestrian zone.

Sidewalk Frontage Zone

- Utility vaults and valves may be placed in the frontage zone. Placement of utility structures in this zone is preferred only when incorporating utility vaults into the furniture zone is not feasible.
- Utility vaults in the frontage zone should not be located directly in front of building entrances.

Curb Extensions

- Utility vaults and valves should be minimized in curb extensions where plantings or street furnishings are planned.
- Surface-mounted utilities may be located in curb extensions outside of crossings and curb ramp areas to create greater pedestrian through width.
- Utility mains located in the parking lane and laterals accessing properties may pass under curb extensions. With curb extensions or sidewalk widenings, utilities such as water mains, meters, and sewer vents may remain in place as they can be cost prohibitive to move.

Driveways

- Utility boxes may be located in driveways if the sponsor provides a vehicle-rated box; however, this is not a preferred solution due to access difficulties.

Pedestrian Crossings and Curb Ramps

- New utility structures should not be placed within street crossing and curb ramp areas.
- Existing vaults located in the center accessible portion of a ramp should be moved or modified to meet accessibility requirements, as feasible, as part of utility upgrades.
- Catch basins and surface flow lines associated with storm drainage systems should be located away from the crosswalk or between curb ramps. Catch basins should be located upstream of curb ramps to prevent ponding at the bottom of the ramp.

Consolidation

Utilities should be consolidated for efficiencies and to minimize disruption to the streetscape:

- Dry utility lines and conduits (telephone, CATV, electric, gas, etc.) should be initially aligned, rearranged, or vertically stacked to minimize utility zones.
- Wherever possible, utility conduits, valves, and vaults (e.g., electrical, street lighting, and traffic signals) should be consolidated if multiple lines exist within a single street or sidewalk section.
- Dry utilities (gas, telephone, CATV, primary and secondary electric, streetlights) may use shared vaults wherever possible. San Francisco has proposed shared vaults with predetermined color coded conduits per predetermined city standards.
- Street lighting, traffic signal, and light rail or streetcar catenary poles should share poles wherever possible. When retrofitting existing streets or creating new streets, pursue opportunities to combine these poles.

Other Design Guidelines

- Street design and new development should consider the overall pattern of plantings, lighting, and furnishings when placing new utilities in the street, and locate utility lines so as to minimize disruption to the prevailing streetscape rhythms.
- Utilities should be located underground wherever possible, as opposed to overhead or surface-mounted. Overhead utilities should be located in alleys where possible.
- New utilities should use durable pipe materials that are resistant to damage by tree roots and have minimal joints.
- Trenchless technologies, such as moling and tunneling, should be used wherever possible to avoid excavation and disruption of streetscape elements.
- New infrastructure projects should use resource-efficient utility materials. Re-used or recyclable materials should be incorporated wherever possible.
- Utility boxes may be painted as part of a public art program.
- Tree removal should be avoided and minimized during the routing of large-scale utility undergrounding projects.

- Any utility-related roadway or sidewalk work should replace paving material in kind (e.g., brick for brick) where removed during maintenance, or replace with new upgraded paving materials.

New Development and Major Redevelopment

- Alleys for vehicle, utility, and service access should be incorporated to enable a more consistent streetscape and minimize above-ground utilities.
- New utilities should be located to minimize disruption to streetscape elements per guidelines in this section.

Abandonment

- Currently abandoned dry conduits should be reused or consolidated if duplicate lines are discovered during street improvement projects. Utilities should be contacted for rerouting or consolidation. Where it is not possible to reuse abandoned mains, conduits, manholes, laterals, valves, etc., they should be removed per agency recommendations when possible to minimize future conflicts.
- Abandoned water and sewer lines may be retrofitted as dry utility conduits where available or if possible to minimize the need for future conduit installations.

Process

- Utility installation and repair should be coordinated with planned street reconstruction or major streetscape improvements.
- New development should submit utility plans with initial development proposals so that utilities may be sited to minimize interference with potential locations for streetscape elements.
- Utility work also offers opportunities to make other changes to the street after the work is completed and should be coordinated with planned improvements to avoid duplication of efforts or making new cuts in new pavement. Examples of

improvements to streets that can be done at low cost after utility work include restriping for bike lanes if utility work requires total street repaving, as well as building sidewalks in conjunction with utility work occurring outside the traveled way.



Street lamps (Credit: Sky Yim)

Lighting

Lighting provides essential nighttime illumination to support pedestrian activity and safety as well as vehicle safety. Well-designed street lighting enhances the public realm while providing safety and security on roadways, bike paths, and lanes as well as pedestrian paths including sidewalks, paths, alleys, and stairways.

Historically significant street light poles and fixtures should be maintained and upgraded where appropriate.

Pedestrian lighting should be coordinated with building and property owners to provide lighting attached to buildings for sidewalks, alleys, pedestrian paths, and stairways where separate lighting poles are not feasible or appropriate.

Guidelines

Location and Spacing

(1) Street and pedestrian lighting should be installed in the sidewalk furniture zone; (2) light fixtures should not be located next to tree canopies that may block the light; (3) where pedestrian lighting is not provided on the street light pole, special pedestrian lamps should be located between street light poles.

Light Color

All light sources should provide a warm white (yellow, not blue) color light

Light Poles and Fixtures

Design should relate and be coordinated with the design of other streetscape elements and recognize the history and distinction of the

neighborhoods where the light poles are located.

Dark-Sky Compliant Lighting

As appropriate, dark sky-compliant lighting should be selected to minimize light pollution cast into the sky while maximizing light cast onto the ground.



Dark sky compliant lighting: Tucson, AZ (Credit: Brad Lancaster)

Energy Efficiency

Solar light fixtures should be utilized where possible for new installations or for retrofit projects. Where solar light fixtures are not appropriate or possible, LED or a future more energy-efficient technology should be used.

Pedestrian Lighting

Retrofits of existing street lights and new installations should provide lighting on pedestrian paths. Pedestrian lighting should be added to existing street light poles where feasible unless spacing between street light poles does not support adequate pedestrian lighting, in which case pedestrian lighting may need to be provided between existing street light poles.

Light Levels and Uniformity

All optic systems should be cut off with no light trespass into the windows of residential units. Cities should develop a set of standards for pedestrian lighting levels based on Table 11.3 to achieve adequate lighting.

Table 11.3 Pedestrian Light Levels

Streetscape Type	Light Level
Commercial	1 fc
Mixed-Use	0.5 fc
Residential	0.4 fc
Industrial	0.3 fc
Alleys and Paseos	0.3 fc
Special	Varies

Note: Light levels are measured in foot candles (fc).

Suggested light levels are consistent with ANSI/IES RP-8-00 American National Standard Practice for Roadway Lighting

ADDITIONAL SELECT RESOURCES

Lancaster, B. Rainwater Harvesting for Drylands and Beyond, <http://www.harvestingrainwater.com/>

Landscape Architecture Foundation’s Landscape Performance Series, www.lafoundation.org/lps

CHAPTER 12. RE-PLACING STREETS: PUTTING THE PLACE BACK IN STREETS

INTRODUCTION.....	12-2
PUBLIC SPACE AND THE NEED TO RE-PLACE STREETS.....	12-3
PLACEMAKING FOR STREETS.....	12-4
Design Techniques and Goals for Replaced Streets.....	12-5
STRATEGIES TO RE-PLACE STREETS.....	12-10
The Street's Place in the Community.....	12-10
Placemaking Participants.....	12-10
The Placemaking Process.....	12-11



INTRODUCTION

Most American cities have come to view streets primarily as conduits for moving vehicles from one place to another (from A to B is the common expression). While moving vehicles is one of their purposes, streets are spaces, even destinations in and of themselves. Conceiving of a street as a public space and establishing design guidelines that serve multiple social functions involves several fundamental steps. Behind them all is a redefinition of whom streets ought to serve. By approaching streets as public spaces, cities redirect their attention from creating traffic conduits to designing a place for the people who use the street.

People put the place back in streets.

This chapter describes the need for cities to “re-place” their streets—make streets places and refocus their purpose on the people who use them—and how cities can do so. The chapter outlines the key features and functions of re-placed streets and the design elements used to achieve re-placed streets. The chapter concludes by describing the process cities can follow to ensure streets come to reflect a community’s strengths, needs, and aspirations.



Pavement to Parks program: San Francisco, CA (Credit: Sky Yim)

PUBLIC SPACE AND THE NEED TO RE-PLACE STREETS

Public spaces are the stages for our public lives. They are the places shared by all members of a community, of any size. Quality public spaces are places where things happen and where people want to be, vital places that highlight local assets, spur rejuvenation, and serve common needs.

Streets comprise a large portion of publicly owned land in cities and towns. Streets are a huge part of any community's public space network, and historically served as meeting places, playgrounds for children, marketplaces, and more. As populations spread out from city centers, streets lost many of these functions and were instead designed and planned for one use: mobility. At best, streets conceived as complete streets address the mobility needs of all street users (pedestrians, cyclists, drivers, and transit riders). During the last century, however, automobiles have been prioritized over people as users of our streets.

As part of the public realm, successful streets have a variety of functions beyond allowing automobiles to travel rapidly. For this reason, placemaking, the process of creating high-quality destinations, must be at the core of the planning and design of our streets to meet the following challenges:

- **Population growth and urbanization.** People moving back into cities will need to be accommodated in limited space, putting greater demands on existing streets. If streets continue to largely function to move people traveling in motor vehicles, they will not be able to accommodate this growth. Streets will need to enable people to do more while traveling less and to travel more efficiently.
- **The need to maximize social and economic exchange.** Streets will need to serve the highest and best use for the land they are on, and mobility is only one among many possible uses. Streets need to be designed to maximize social value, which also spurs healthy economic exchange. In this way, streets become arteries distributing prosperity. Streets that invite social interaction are more likely to ensure healthy growth.
- **The need to reduce energy consumption and induce sustainable growth.** Streets that are places promote locality. They enable people to travel comfortably by non-motorized modes, which in turn shortens travel distance demand. With growing concerns regarding fuel resources and climate change, this shift will be critical. Because re-placed streets spur locality-serving commerce and social venues, they also set the stage for

and enable healthy and environmentally sustainable practices/ behaviors in the surrounding built environment.

- **A desire to create public space.** Beyond being the frames for other development, streets can be public spaces themselves. Access to public space is critical to safe, healthy, and successful communities. When streets are designed as great spaces for people, they reinforce a sense of belonging and build on the strengths of the communities they host.

PLACEMAKING FOR STREETS

In order to be places, streets must

- Augment and complement surrounding destinations, including other public spaces such as parks and plazas
- Reflect a community's identity
- Invite physical activity through allowing and encouraging active transportation and recreation
- Support social connectivity
- Promote social and economic equity
- Be as pleasant and accessible for staying as for going
- Prioritize the slowest users over the fastest
- Balance mobility and public space functions



Public plaza: Barcelona, Spain
(Credit: Ryan Snyder)

So that people can

- Walk and stroll in comfort
- Sit down in nice, comfortable places, sheltered from the elements
- Meet and talk—by chance and by design
- Look at attractive things along the way
- See places that are interesting
- Feel safe in a public environment



Public art: Alhambra, CA
(Credit: Sky Yim)

- Enjoy other people around them
- And get where they need to go!

Re-placed streets must be slow streets that are inviting and filled with human activity. This is the most important distinction between streets designed for maximal car throughput and re-placed streets; it requires the necessary scalar adjustment from car to people-focused street planning. Streets designed for fast and far movement favor people moving by motor vehicles, not people moving under their own power. Human energy limits people to slow and local movement.

Because people, not motors, are essential to long-term growth in places of all kinds, human-scaled streets are an inducement to healthy lifestyles and economic resilience.

Design Techniques and Goals for Replaced Streets

A re-placed street balances the moving and staying needs of its users and has multiple, people-serving purposes. The design techniques and goals detailed below describe how to create re-placed streets.

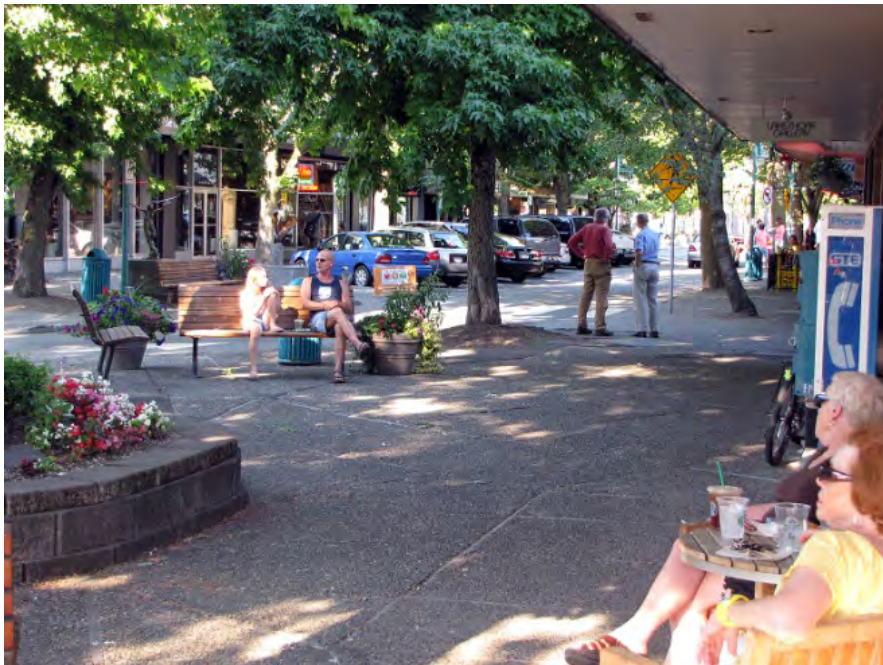

Good public space invites social interaction (Credit: Dan Burden)

Support and Encourage Activities and Destinations

- Widen sidewalks to accommodate multiple activities
- Open streets to multiple activities
- Encourage/provide active ground floor uses in adjacent buildings
- Cluster activities and amenities
- Allow street vendors and performers

Design Street Elements and Adjacent Buildings for the Human Scale

- Use amenities that are pedestrian-scaled including
 - Signs
 - Lighting
 - Seating
- Encourage building design (e.g., through zoning regulations and design guidelines) that is scaled to the human body, such as
 - Frequent building entrances
 - Building transparency at street level
 - Interesting facades

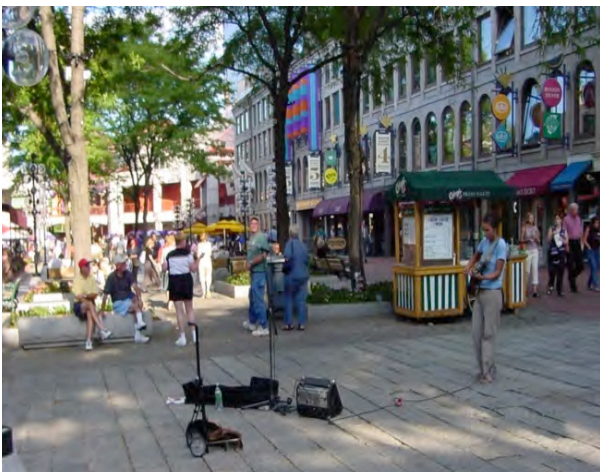

Street performer (Credit: Ryan Snyder)



Pedestrian-scale lighting: Los Angeles, CA (Credit: Ryan Snyder)



Walk streets used as play space:
Manhattan Beach, CA
(Credit: Dan Burden)



Transparent storefronts blur the
distinction between indoor and
outdoor space, and public and private
space: Avalon, CA
(Credit: Ryan Snyder)



Good sidewalk buffer: Glendale, CA
(Credit: Ryan Snyder)

Provide a Feeling of Safety and Security on Streets

- Keep streets well-maintained and both the street and surrounding buildings well-lit
- Select streets adjacent to round-the-clock-active buildings and public spaces
- Invite diverse people and uses throughout the day
- Slow traffic to a comfortable speed to mix with other travel modes through
 - Low speed design elements
 - Traffic calming techniques
 - Shared space
- Maintain a buffer between pedestrians and vehicles when there is fast moving traffic using
 - Planters
 - Bollards
 - Parked cars
 - Kiosks, newsstands, public toilets, lampposts

Connect Both Sides of the Street

- Shorten crossing distance through
 - Narrow travel lanes
 - Curb extensions and pedestrian islands
 - Building activities connected to the street
- Invite people to cross in more places by
 - Slowing vehicular traffic
 - Establishing mid-block crossings
 - Making shared streets



*Shared space: Zurich, Switzerland
(Credit: Ryan Snyder)*

Show a Sense of Ownership

- Provide for maintenance and cleanliness
- Engage community/local residents in maintenance
- Accommodate diverse programming appropriate for the season and time-of-day, such as
 - Greenmarkets/farmers' markets
 - Fairs and festivals
 - Ciclovía-style events
 - Volunteer events



*CicLAvia event: Los Angeles, CA
(Credit: Ryan Snyder)*

Reflect Community Identity

Unique community identity draws from the natural setting and local history, as well as the cultural backgrounds of community residents and their architectural tastes.

- Showcase local assets including
 - Monuments and building architecture
 - Views
 - Trees and other plants



Farmer's market
(Credit: Dan Burden)

- Other natural features (water, topography)
- Parks and plazas
- History
- People
- Intersections transformed into meeting places
- Invite a diversity of users
- Reference or preserve continuity of local aesthetics

Move Community towards Local Sustainability

- Utilize on-site and local resources where possible
- Use surface area for energy capture
- Use effective stormwater management techniques including
 - Bioswales
 - Raingardens
- Use open space for growing food (community gardens)



Statue: Santa Fe, NM
(Credit: Ryan Snyder)



Historical street marker: Avalon, CA
(Credit: Ryan Snyder)

STRATEGIES TO RE-PLACE STREETS

Re-placing streets requires building streets around a community's vision that the street can support. Re-placing a street is an opportunity to open a process wherein communities remind themselves of their strengths and establish a shared and sustainable vision for their future. Before a city can proceed with street redesigns that create a sense of place, it must address the following issues.

The Street's Place in the Community

Streets, the built environments they connect, and the people who use them compose a community. Thus, it is important to situate the street in its spatial context and identify the places it connects. It is equally important to identify whose needs the street should serve. This may include tenants and property owners, students, employees, local civic associations, and religious institutions.

Placemaking Participants

At the heart of placemaking is the idea that each community has the means and the potential to create its own public spaces. Before a city can proceed with street redesigns that attend to the multiple functions of public space through placemaking, it is important to identify who needs to be involved to frame the meaning of place and the vision for that community and to provide the needed information, resources, and expertise to realize that vision.

The Community

Since place is an outgrowth of community character, re-placing should invite the collective influence of a community's diverse residents and users. In re-placing a street, it is important to establish who has a stake in the neighborhood, and give all of these groups and individuals the opportunity to come to the table and contribute. As noted above, the groups may include tenants and property owners, students, employees, and community-based groups like civic associations and religious institutions. The appropriate public space functions of streets should be defined by these multiple users, often referred to as "stakeholders."

Multiple Agencies

Within a city, multiple agencies should be included and engaged in replacing a street. A department of transportation alone cannot create a street that is a place. Any agency with responsibility for the regulation, construction, operations, or maintenance on or adjacent to the street should be included in the project early in the process. In addition to the department of transportation, this might include public works, the parks department, utilities, and the planning or zoning department. All agencies must bring their needs and constraints to the table, but more importantly they must understand the community's vision and goals for making the street a place. They can then begin considering what they need to do to carry out the will of their community.

A Multi-Disciplinary Team

A successful street is a complex place, and the information, insight, and skills required to make it a successful place are many and diverse. It is beyond the experience of any one profession to deal with any of these issues. The role of professionals is as a resource for the community and to implement the community's vision.

The Placemaking Process

The placemaking process should be fun, engaging, and empowering for a community; build on existing human resources; and result in increased community social capital. Chapter 15, "Community Engagement," provides the details of the type of public process that should be used to ensure community involvement and place-based planning. Below are processes especially important to placemaking.

Establish a Community Vision of What the Street Is and Should Be

Infrastructure forecasts what later springs from the built environment: a street's public space functions can be an inducement to a community's growth aspirations and not just an accommodation of existing behavior. Determining the optimal uses and design for a given community's streets involves identifying the strengths and needs of its users. Because it involves a scalar adjustment, this is the most important distinction between a street designed to be a place, with many functions, and a

street designed for the single function of maximizing car throughput. A process that allows the community of street users to define these strengths and needs and establish a vision for the street is critical.

Involve the Public in Assessing the Strength, Needs and Opportunities on the Street

The project must start by going directly to the residents and neighborhoods to evaluate and establish a vision for the street. A critical part of this will be an assessment of whether places on the street are performing well or need improvement. The assessment should include a grassroots identification of needs for enhancement of underperforming places and opportunities for the creation of new places so that the street can achieve the critical mass of places needed to function as a destination itself. In addition to places on the street, the community should be engaged in an on-site diagnosis of the street itself to determine how it is performing. A variety of tools and audits exist for such assessments, but at heart they should engage the community in assessing the characteristics, described in the previous section, that make a street a place.

Establish a Community Vision Based on This Assessment

The community process should result in a community-generated vision for what the street can and should be, including the things people should be able to do on the street and the way that people feel doing them. The vision should be generated by people who use the street. Such a vision is generally quite realistic and practical yet contains innovative ideas because the vision is grounded in reality but isn't generated by just one individual or group.

The vision should contain

- A mission statement of goals
- A definition of how the street will be used and by whom
- A statement of the desired character of the street
- Suggestions and a conceptual idea of how the street could be designed
- Models or examples of places that community members would like the street to be like or elements they would like to use

Develop a Plan Based on This Vision

There will need to be a plan for realizing the vision. It might not include every step to realize the vision, but it should begin to lay out next steps and identify things that all partners, including the agencies, the professionals, and the community, can do to move re-placing the street forward.

Prioritize Interventions Based on This Vision

The vision will contain many ideas. However, some will be more important or more critical than others. Additionally, some will be easier to implement than others. The community will need to prioritize individual ideas and strategies in order to begin to take action in re-placing the street.

Select and Implement Short-Term/Temporary/Pilot Projects

First on the action plan should be short-term or pilot projects. Such projects can be a way of testing ideas for long term change at a lower cost while providing flexibility for adaptation and change. Such projects also give people confidence that change is occurring and that the ideas they have contributed matter. This is important because re-placing streets takes time, and smaller, simpler changes can provide small steps that keep people engaged in the process of placemaking. Short-term and pilot projects allow people to see how the street is



Examples of low-cost, short-term devices that transform streets: San Francisco, CA (Credit: Sky Yim)

working with changes introduced gradually over time, enabling people's perceptions of how the street functions and what it should be to change and reducing resistance to change.

New York, San Francisco, Portland, and other cities have quickly transformed streets into vibrant public space with such techniques as

- Establishing non-vehicular space with planter boxes, temporary curbs, and wooden platforms
- Painting the pavement under the newly repurposed space
- Bringing in portable tables, chairs, and awnings
- Incorporating decorative street painting projects

Establish a Maintenance and Management Plan

Maintenance and management is critical because streets are not static—they change daily, weekly, and seasonally—and streets must adapt and be flexible to this change. Thus, public space management may be required. Management becomes especially critical where events, such as farmers' markets, fairs, festivals, and *ciclovías*, are programmed. Great streets are also well loved and well used. To sustain a quality street environment, the community must commit to long-term investment in the re-placed street.



Examples of low-cost, short-term devices that transform streets: Broadway, New York, New York (Credit: Paul Zykofsky)



Example of low-cost, short-term devices that transform streets: Broadway, New York, New York (Credit: Paul Zykofsky)

Chapter 13. DESIGNING LAND USE ALONG LIVING STREETS

INTRODUCTION.....	13-2
ESSENTIAL PRINCIPLES FOR BALANCED STREET ENVIRONMENTS.....	13-3
STREETScape ENVIRONMENT TYPES.....	13-5
Neighborhoods.....	13-5
Neighborhood Centers.....	13-7
Corridors.....	13-9
Urban Centers.....	13-11
Special Use Districts.....	13-13
Urban Design.....	13-15
Thoughtful Site Design.....	13-17
Buildings' Relationship to Sidewalk.....	13-18
Appropriate Building Forms.....	13-19
POTENTIAL IMPLEMENTATION STRATEGIES.....	13-22
HEALTH AND LAND USE.....	13-24



INTRODUCTION

Streets provide access to buildings and land uses of every kind. As discussed in Chapter 12, “Re-Placing Streets,” placemaking is the practice of first designing streets and other public spaces as an interconnected network of human-scale “public living rooms” in which the safety and comfort of pedestrians and bicyclists is not subordinated to the requirements of access by automobile, and then coordinating the character and design of the adjoining properties to create a specific type of living environment, or place.

All successful and sustainable communities include a range of distinct and different types of places, or environments, from quiet, shady residential streets to busy neighborhood centers, from noisier mixed-use “bright lights” downtowns to larger, single-purpose industrial and employment centers. While the type of land use is one important characteristic of private property design in these places, site and building design are critically important in ensuring that coherent, safe, functional, and valuable places result.

This chapter provides a discussion of the ways in which the planning and design of properties contribute to coherent placemaking. The discussion includes placemaking principles that are applicable to places of all types and to distinct types of places, design techniques for applying the basic placemaking principles, and implementation strategies for embedding these principles and techniques in local policies and regulations.



Complementary land-use and street design (Credit: Dan Burden)

ESSENTIAL PRINCIPLES FOR BALANCED STREET ENVIRONMENTS

*Neighborhood public square
integration: Buenos Aires, Argentina
(Credit: Ryan Snyder)*



The following design principles inform the recommendations made in this chapter and should be incorporated into all street environment design:

- Urban patterns in livable, sustainable places of enduring value are generally based on compactness, connectivity, completeness, and continuity. This describes the opposite of sprawling, disconnected, or single-use development.
- Streets are the outdoor rooms of their neighborhoods, and should be designed for and scaled for people. They are also the structural framework that organizes those places, making them legible and navigable.
- The purpose of streets is to let people move about, and every street should provide safety, convenience, and comfort for pedestrians and bicyclists.
- Streets, parks, plazas, squares, and other public places make up the public space network in which all members of the community may encounter one another in the course of their daily lives, regardless of their age, income, or other individual status.
- Street networks designed with pedestrians in mind, as described in Chapter 3, “Street Networks and Classifications,” naturally form small to medium-sized blocks that allow pedestrians to

comfortably walk to a range of amenities as a pleasant and practical alternative to driving. In existing environments where such a network exists it should be preserved, and in areas where large parcels are being redeveloped, such a network should be inserted.

- The distribution of land uses should be designed to allow everyday destinations (e.g., schools, parks, and retail shops) to be located within a comfortable walking distance of most residences.
- All buildings should contribute to the character of the streetscape, face the street with attractive entrances that welcome pedestrians, and have windows that overlook the street to create a sense of security.
- On-street parking reinforces a pattern in which visitors enter buildings from the street, and can provide an important buffer between pedestrians and moving traffic.
- The setback between buildings and the sidewalk should be designed to enhance the pedestrian experience, whether setbacks are attractive landscaped yards that provide privacy for building occupants or shopfronts at the sidewalk that display merchandise to passing pedestrians. In no cases should cars, parked or moving, be placed between the sidewalk and the buildings.
- Off-street parking and service access and their driveways should be designed to disrupt the pedestrian experience as little as possible. Whenever possible, access should be from an alley or shared driveway off a side street and parking and garages should be located behind or beside buildings, not between the sidewalk and the building. When a driveway to the front of the lot cannot be avoided, it should be as narrow as possible.
- Off-street parking, especially surface parking, is a non-productive use, and the amount required should be reduced to the extent possible by utilizing on-street parking and by sharing off-street parking among adjacent uses. Off-street parking requires about twice the surface area per parked car of on-street parking, due to the driveways required to access the lot and aisles needed for maneuvering within the lot. This non-productive space creates dead zones and increases the distances between destinations, further reducing the attractiveness of walking.

- The mix and intensity of land uses should be designed to support and be supported by efficient transit systems whenever possible.



*Good building setback
(Credit: Ryan Snyder)*

STREETSCAPE ENVIRONMENT TYPES

Every city, town, neighborhood and district is unique. This uniqueness creates a sense of place. However, there are a few general types of places that repeat from community to community, within which the idealized relationship of street to adjacent land uses follows certain general guidelines. The following descriptions of archetypical environments detail concepts and strategies, not finite design solutions. Designs should be based on the best of the local and regional architectural and landscape heritage. Communities may want to establish their own typologies for local environments and streets.

Neighborhoods

Neighborhoods are the main component of all cities, the places where almost everyone lives. Many of the concepts below are part of California's best loved and most valuable neighborhoods, and some of the best new neighborhoods now being built are based on these simple concepts:

- Residences of various types are the predominant land use of neighborhoods, with other uses such as neighborhood-

serving retail, small businesses, elementary schools, parks, and playgrounds within a pleasant walk.

- Neighborhoods can be composed primarily or even exclusively of single family homes, or can include a range of multifamily housing types that are designed and scaled for their compatibility with houses. The basic design principles listed here are the same for both.
- Neighborhood streets are the living rooms and play rooms of the neighborhood, and should be designed mainly for the safety and enjoyment of pedestrians, particularly children and the elderly, the most vulnerable pedestrians among us.
- The streetscape environment of neighborhoods is the most heavily landscaped type, with sidewalks flanked by street trees and landscaped parkway strips on the public side and landscaped front yards on the private. This creates a distinctive streetscape character different from that in neighborhood centers and other mixed-use environments.
- On-street parking serves visitors and residents, and provides a valuable buffer between pedestrians, children at play, and passing traffic.
- Buildings should front the street with gracious front doors and overlook the street with windows to provide eyes on the street and a sense of security for the street.
- Front yard design should create spaces through which residents and visitors come and go in their daily routines, in which neighbors interact and children play, and where food can be grown.
- The front door of houses and active uses within them should be closer to the street than the garage to emphasize the home over car storage and to bring eyes closer to the street.
- Automobiles should disrupt the pedestrian environment (primarily sidewalks) as little as possible. This can be accomplished by providing access to parking and garages via alleys and driveways from side streets, or when necessary via driveways from the fronts of lots (as few and as narrow as possible) to access garages located behind or beside, not in front of, the residences.



*Neighborhood center: Glendale, CA.
(Credit: Ryan Snyder)*



Streets and buildings working together create attractive neighborhoods. (Credit: Ryan Snyder)

Neighborhood Centers

Neighborhood centers take many forms and occur at all scales, from a country store at a key intersection in a rural neighborhood to a busy little “Main Street” environment in a larger town or city to a high intensity, transit-oriented center at a neighborhood edge along a major urban corridor. Regardless of the scale and character of the neighborhood center, the following set of basic design concepts can define centers that are convenient to pedestrians from adjoining neighborhoods:

- Neighborhood centers, the name notwithstanding, are generally at the edges or corners of neighborhoods, facing a major street or streets that carry traffic volumes capable of supporting the businesses. An ideal arrangement is a “Main Street” that is located at the conjunction of two or more neighborhoods, making the edges of the neighborhoods into the center of the larger community, and providing a range of amenities and resources within easy walking and biking distance of the residents.
- Neighborhood centers are ideally mixed-use, providing an array of goods, services, employment, and residential options that can function both as an extension of the adjoining neighborhoods and as a convenient destination for people passing through.

- The buildings of these centers should face the primary street, creating a busy pedestrian environment that causes drivers to slow down and see what the center has to offer.
- The ground floor uses in neighborhood centers are generally commercial, providing convenient goods and services to customers; the upper floors can be residential, office, or a mix of both.
- The streetscape in neighborhood centers is usually quite formal: street trees are normally located in small planters within the sidewalk, surrounded by tree grates or very small landscaped areas, providing space for pedestrians to comfortably stroll, and for people to get in and out of cars parked curbside.
- There are many options for the design of setback areas in neighborhood centers, including forecourts with sidewalk dining, narrow landscape zones that soften the streetscape while allowing views of the shops, and simple shopfronts built right to the sidewalk.
- Neighborhood centers can also include purely residential buildings, as long as the design of the ground floor street interface provides a degree of privacy for the residents, either by setting the building back behind a landscaped yard or raising the ground floor above the sidewalk level, or both.
- Except for the smallest centers, which might just be one corner store, neighborhood centers generally require off-street parking, which should be located behind or alongside the buildings whenever possible, not between the sidewalk and the buildings.
- In larger neighborhood centers that require large off-street parking lots, the size of the lots can be reduced if they are shared by uses whose peak parking demand is in the daytime (offices) and uses whose peak use is at night (e.g., dinner restaurants and residences). Reducing parking saves cost, improves environmental performance, and improves the urban environment for people.
- Plazas can create vibrant urban centers. Their design should focus on proper size and scale, active uses, doors and windows fronting the plaza, trees, landscaping, public art, fountains, etc. Stages, bandstands, play fountains, and other features liven plazas.



*Public plaza: Barcelona, Spain
(Credit: Ryan Snyder)*

Corridors

This section focuses on major street corridors that connect across an urban area. Corridors can have many different characters and occur at all scales, from a rural main street stop along a highway to a main avenue within a town or a high intensity urban corridor in a large city. Many planning and design concepts are common to corridors at all these scales.

Many major street corridors began as rural roads, evolved into automobile thoroughfares lined with a range of commercial uses, and have lately been losing much of their commercial value, as retail and office uses have migrated to larger-format retail centers and business parks. Many such corridors now present a significant opportunity for communities to provide infill housing mixed with modest amounts of commercial uses within walking distance of adjoining neighborhoods. The repositioning of these often blighted “commercial strips” as more valuable mixed-use places requires a coordinated redesign of the streets and careful planning of the infill development along the corridor.

The street design principles and practices described in this manual will help create streets that do more than move cars. Using these principles and practices, undifferentiated miles of corridors can be restructured to provide the types of neighborhood centers described above, interspersed with residential or office uses along the street. The core placemaking strategies found in this manual (slowing cars, planning for people, landscaping streets, providing on-street parking, and designing property setbacks to modulate privacy for residences



*Mixed-use building: Los Angeles, CA
(Credit: Ryan Snyder)*

and visibility for businesses) can transform miles of sameness into a sequence of useful places.

Below are some core design concepts and principles that can help to integrate land uses with such streets to make coherent, human-scale places:

- The entire length of a corridor should be lined with active uses. These can include the neighborhood centers described above at appropriate nodes, multifamily housing of various types, and even single-family housing if appropriately buffered with landscaped setbacks or a multi-way boulevard. Sound walls, berms, and other forms of “pure buffer” are an admission of urban design failure, disconnecting the city rather than connecting it, and should be employed as a last resort.
- Through a community visioning process integrated with transit planning processes and retail capacity studies, the location and size of neighborhood centers (active, mixed-use, and often transit-oriented nodes) should be determined.
- Long corridors should be analyzed to define the existing or emerging character by segment, then potential nodes, centers or destinations with more focused pedestrian activity can be identified.
- A mix of land uses can be provided to encourage people to make trips by means other than cars in those locations, and a network of streets to assure connections between uses should be available.
- Design standards or guidelines for development within the segments that will remain auto-oriented should be created so these segments can be made as pedestrian and bicycle-friendly as possible (e.g., minimizing the number of curb cut locations and widths that interrupt the sidewalk, buffering street-frontage parking so the sidewalk environment is not compromised, providing setbacks for landscaping and transit amenities wherever possible to encourage transit use).
- In close consultation with the residents of adjoining neighborhoods, the vision and standards for the design and massing of buildings in each segment of the corridor should be developed.

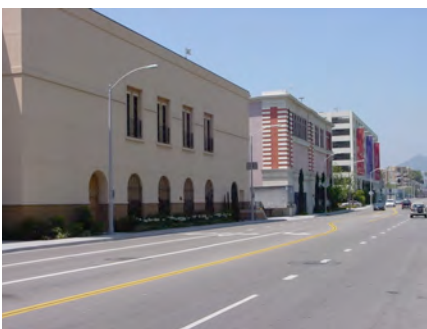

Blank walls and inactive uses on the ground floor make for poor pedestrian environments. (Credit: Ryan Snyder)

Urban Centers

Urban centers are typically the economic and social hearts of cities or towns. They can be village-scale centers in small towns, low to mid-rise downtowns in most cities, or high intensity urban centers with high-rise buildings in larger cities, where unique regional destinations are often located. Ideally, the urban center environment is a very compact mix of a wide range of land uses, creating high land values as well as a high potential for transportation congestion. Accordingly, it is vitally important that in addition to a balanced street network for pedestrians, bikes, and cars, such places be provided with high levels of transit service. Important design concepts for urban centers include the following:

- Urban centers are usually organized around an established network of major boulevards and urban streets that support the businesses and major public institutions. Because networks that are scaled and designed for pedestrians are finite in their traffic carrying capacity, it is critical that transit plays a major role in moving people.
- Urban centers are mixed in use, providing an array of goods, services, employment, and residential options along with important public and cultural institutions.
- Buildings in urban centers should face the primary street (which can often be more than one side of a block), and support an active pedestrian environment.



*Urban center: Vancouver, BC
(Credit: Dan Burden)*

- Buildings in large urban centers should form a consistent street wall (following a consistent pattern of setback and height); the street wall is typically at the back of a wide sidewalk and appropriate to the character of the street it fronts.
- Along streets with purely residential buildings, the design of the ground floor-street interface should provide a degree of privacy for the residents, with residences normally set back from and raised above the sidewalk.
- Commercial uses generally front the sidewalk with large, transparent shopfronts, but some institutional and office uses commonly connect to the sidewalk environment with lobbies and foyers instead. In such cases, it is important that windows from the offices and other interior spaces overlook the street to support an environment that feels safe.
- For hotels and office buildings that require porte-cochere or drop-off areas for residents or guests, these should ideally be designed to occur at the street edge along the curb zone, and should not impose large curb cuts and circular driveways that interrupt the sidewalk. When such off-street vehicular access must be provided, it should be integrated into a forecourt or entry plaza that is designed first as a public space for people, and incidentally allows vehicular access that does not disrupt the pedestrian environment. The width of the pedestrian zone should be maintained throughout; the furniture and/or frontage zones can be reduced.
- Parking in urban centers should include
 - On-street parking to buffer pedestrians from faster moving traffic
 - Shared, aggregated parking that is located underground wherever possible
- Above-grade structured parking should be lined with ground floor active uses that front the streets, not exposed or hidden with blank walls. This also applies to upper floors, where stacking exposed parking levels above the street-level commercial uses should be avoided.
- Where surface parking lots are unavoidable, they should be behind a building that fronts the sidewalk and public street, or at a minimum screened with attractive landscape or public art



Well screened surface parking: Santa Barbara, CA (Credit: Paul Zykovsky)

to provide a comfortable street edge for passing pedestrians. Vendor kiosks or “slim stores” can also be used for this purpose.

- The key to district parking strategies is creating a supply of available parking that is shared by many uses, whose peak parking demands will be at different times of the day and the week. This, together with a strong transit component and an attractive walking and biking environment, will reduce the required amounts of parking, which in turn will save cost, increase real estate utilization, improve environmental performance, and improve the urban environment for people.

Special Use Districts

Special use districts are areas dominated by a single type of land use. One example of this is industrial districts, where manufacturing, production, and distribution of goods are the primary activities. Other examples are employment centers that primarily provide high concentrations of commercial offices, medical centers, and large education campuses. Such districts benefit from a location that provides easy access to regional roads and highways, and the sizes of their buildings, the volumes of truck traffic, and the hours of operation make them generally unsuitable for residential uses.

It is important to note that even within special use districts, there are many opportunities to mix in useful amenities and strong reasons to ensure that all the streets are walkable, bikeable, and served by transit. In industrial, office-dominated, educational, or medical campus districts, this enables restaurants, copy centers, and other support businesses to do well while reducing workers’ need to drive out of the district for



*Outdoor seating livens the street: Culver City, CA
(Credit: Sky Yim)*

basic services. These local-serving commercial uses can thrive if the environment supports their patronage, and housing can be integrated as well. Some key principles for the design of such districts include the following:

Districts can foster a critical mass of related businesses that function well in close proximity to each other (like industrial suppliers and manufacturers, or medical offices and a hospital).

It is important that special use districts be organized around a balanced street network, with development standards to ensure that the urban design does not exclude pedestrians and bicyclists. Many employees and visitors arrive to their jobs by transit or bicycle, so accommodating pedestrians should be as important as moving goods and vehicles between businesses. Many employees who drive or take transit to work walk or bike to local destinations during their lunch breaks.

- Where other uses (e.g., restaurants, cafes, and small convenience stores) are interspersed within the dominant land use, they should provide a pedestrian-friendly street frontage to encourage employees or visitors to arrive from nearby businesses on foot.
- Major corridors entering special use districts typically carry heavier traffic and trucks, but also need to safely accommodate bicycles and pedestrians.
- The street network should assure that truck freight traffic has clear paths of travel that do not encroach on sidewalks.
- Buildings in special use districts should provide a good public face along the streets, with noxious or unattractive uses behind buildings or attractive fences and landscaping.
- For special use districts like medical centers, the building frontage and entrances onto the campus and its individual buildings from the sidewalk should be pedestrian friendly and accommodate the mobility impaired. Services open to the public, such as cafés and gift shops, should face the street.

- Campuses, which are generally composed of larger areas without public streets, should have a clear network of pedestrian paths and streets that encourage walking and biking, not driving, and allow neighboring pedestrians and bicyclists to cut through the campus.
- Setbacks in special use districts will vary based on the street and sidewalk character the buildings front; landscaping should be provided along public sidewalks and shade trees should be provided to reduce the effects of urban heat islands, which are common in highly paved industrial districts.
- Parking in special use districts could include on-street parking to buffer pedestrians from faster moving traffic, and where provided onsite should be connected to clear, safe pedestrian pathways.
- Loading docks and service functions should be designed to not conflict with pedestrian entrances from sidewalks into the facility.



UCLA Campus (Credit: Ryan Snyder)



The “public room of the street” is an important public space primarily shaped by the land uses and buildings that enclose it (Credit: Cityworks Design and Michele Weisbart)

Urban Design

Urban design is the design of urban environments, whether in small villages, neighborhoods, town centers, or major urban districts. While sometimes used to describe just the selection of sidewalk patterns, benches, and streetlights, the term “urban design” is used here in its broadest and simplest sense: the design of environments in which people live, work, shop, and play.

“Land use” is commonly used as a rough synonym for urban design, and often as a substitute for words such as “building,” “business,” “parking lot,” or anything else that is located on a parcel of private property. In this manual, the term is used to refer to the “use” of the “land” in question. Urban design encompasses site design and street design along with the allowed uses within a certain block or district of a city, and defines the nature of people’s experience of that place. The design and use of private development—collectively the “private realm” of the city—work in tandem with and shape the public realm of the city, defining the overall character of the place. When the design of the private and public realm work well together, the places they make are often experienced as “great streets” or “great places,” and desirable destinations.

Once the community decides on the desired character of the urban environment and the range of allowed land uses is determined, zoning regulations and development standards are prepared to support the desired type of place and street, so that the buildings that are

developed (or are redeveloped) on each parcel play the appropriate supporting role in “completing the street.”

Creating great streets with good private realm design starts at the initial phase of laying out a project on a site, including the location and design of the building(s) and the design of the access, parking, and landscape. The following principles are general and are written based on practices that support livable and healthy communities through (i) thoughtful site design, (ii) appropriate building forms, and (iii) good relationships between the building and the sidewalk and street that it fronts.

*Urban design considers the relationship of site and building to the street, creates spaces for people, and can define the overall streetscape character: West Hollywood, CA
(Credit: Lisa Padilla)*



Thoughtful Site Design

The orientation of every building affects that building’s relationship to people on the street. Each component of building demands careful site design. The following provide site design guidance:

- New projects or buildings developed on large parcels should form new blocks and streets that create a comfortable and walkable block size to help complete the network of streets (see Chapter 3, “Street Networks and Classifications”).
- Buildings should be sited to support good connectivity to the center or neighborhood destinations that are nearby.
- Buildings should be oriented to the street to promote sidewalk activity and provide eyes on the street for the safety and comfort of pedestrians.

- The design of the site should minimize disruptions of pedestrian ways, whether sidewalks or mid-block passageways (typically by limiting the number and width of driveways).
- All buildings should be sited with their primary entries and fronts along the sidewalk, to encourage access from the sidewalk and on-street parking on foot.
- The number of driveways should be limited and consolidated. They should be no wider than necessary and designed to allow motorists to see pedestrians on the sidewalk.
- Parking lots and service entrances should be located toward the rear of the lot, accommodating automobiles but making it comfortable for people to access the buildings on foot.
- Wherever buildings are not built immediately adjacent to the public sidewalk, a coherent network of pedestrian routes should extend into the property so that pedestrians approaching from the street can access each building without walking through vehicular drives and parking lots.
- In all cases, the building pattern within a block should be designed to form comfortable, habitable outdoor spaces that promote a “sense of place” and a unique local character. Each building belongs to an individual or a business—the “community” is what happens between the buildings.
- The impacts of building form and site design on the larger neighborhood or district environment should be taken into consideration. For example, storm water can be managed on private property to reduce demands on the street infrastructure (collection and percolation), poorly functioning irrigation systems can be corrected (to minimize water waste and unnecessary run-off to the street), and building forms can be designed to provide access to fresh air and sunlight to their occupants and passersby on the sidewalk.

Buildings' Relationship to Sidewalk

Each building directly interacts with the adjacent sidewalk on a micro level. The following provide guidance for designing buildings with sidewalks in mind:

- Buildings contribute to the overall character of the street by providing well-designed frontages and clear entry points from the sidewalk.
- For active mixed-use and commercial streets, building frontages should be mostly transparent with “active storefronts” that allow pedestrians to see into shops, restaurants, and public spaces.
- Along residential streets, building frontages should include windows overlooking the street with a layering of landscape, porch, patio, or semi-public space that buffers appropriately (setbacks will vary based on street typology and scale of the buildings).
- The primary building face should be located on the most active street frontage with an attractive and welcoming facade that includes entry doors, windows, signs, and other character-defining elements.
- The secondary building face that exists along a mid-block passage or side street should also include openings overlooking the public space.
- The tertiary (back) side of the building is located along a back alley or service drive where pedestrian movement is secondary to service, with loading docks, service entries, trash storage, and other unattractive functions accommodated here.
- Blank walls should be limited to the rear, and very limited along the secondary face.
- Lighting should be integrated into the building design to indirectly illuminate the sidewalk at night through (i) light filtering through storefront windows, and (ii) architectural lighting that features the building itself and enriches the street environment at night.

Appropriate Building Forms

Every building interacts with the street, so the details of key aspects of its form need careful consideration. The following provide building form design guidance:

- Building height, density, and setbacks are planned and designed to create a specific type of place that has a certain scale and character closely coordinated with the street typology.
- Building design standards should be developed to support a healthy street environment for pedestrians: for example, designing buildings to take into account how they interact with strong winds to create wind tunnels or unnecessarily restrict flows of natural light and air.
- On active mixed-use and commercial streets the design of the lower 3 to 4 floors should have an appropriate level of transparency and detail to support a great sidewalk environment for pedestrians.

Walkable Streets



Everything from the block size to the design of buildings and open spaces contributes to making walkable streets
(Credit: Cityworks Design)

- Buildings of 1 to 3 stories should be designed entirely at a pedestrian-oriented neighborhood scale, with features that can be appreciated by people walking or bicycling.
- Mid-height buildings of 4 to 6 stories should be designed at a pedestrian-oriented scale at the lower 2 to 3 floors and integrate windows, balconies, and other features that provide opportunities for occupants to overlook the street from upper floors.
- Taller buildings (over 6 stories) should generally have a base of lower floors designed similarly to those of mid-height buildings, and may benefit by stepping back from the frontage above this level to provide a street character that is not overwhelming to the pedestrian.
- In most mixed-use districts and neighborhood centers, it is more important to provide a relatively steady “street wall” to define a simple “street as an outdoor room” than to provide varied setback and stepbacks to “break up the mass” (see preceding section on streetscape environment types). In suburban environments where buildings stand free in the landscape, the desire to articulate the building form is understandable. But in urban districts and centers the primary placemaking role of buildings is to calmly define the space of the place rather than to “express themselves” as unique objects.
- Towers in very dense districts (like an urban center) should be slender and mostly transparent, with a low to mid-rise base that provides pedestrian-oriented features. Towers should be designed to appear attractive and approachable from the street and sidewalk, not just to be an icon in the skyline.
- Parking should be integrated into the site and building design; ideally parking would be (i) underground, or (ii) tucked behind the building fronting the sidewalk and accessible from an alley or side street, or (iii) sited internally to the project or block so buildings “wrap it” to the greatest degree possible
- Buildings should be designed applying universal access principles (like locating stairs in prominent locations to encourage people to use them) making naturally legible paths through good design and an integrated site and building design approach.

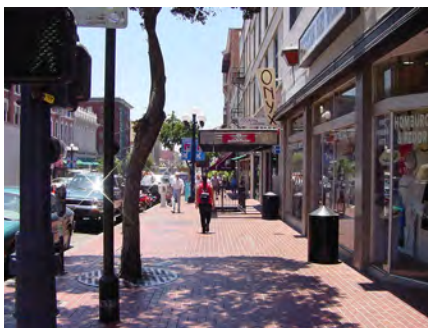

*Active ground floor uses
(Credit: Ryan Snyder)*

POTENTIAL IMPLEMENTATION STRATEGIES

Tools available to help implement good urban and architectural design that support the creation of good streets and great places include the following:

- Community-based vision plans, which are critical agreements or road maps that articulate how communities see their streets, neighborhoods, districts, and future growth
- Zoning standards that allow, encourage, and require a diverse mix of land uses that support the creation of sustainable, valuable places
- Standards and guidelines associated with this type of zoning that shape and coordinate development with street design to ultimately deliver residents and stakeholders a fully realized vision that is authentic and unique to their community, and that supports a healthy, pedestrian-centered lifestyle



*Outdoor sidewalk social environment with activities for all ages: Venice, CA
(Credit: Dan Burden)*

HEALTH AND LAND USE

Good land use planning and urban design can help create healthy neighborhoods with great streets and innovative and sustainable buildings. Some planning principles that should be considered include the following:

- Create a variety of places where people choose to walk and feel safe doing so—walking is an important form of daily exercise that can easily be integrated into the design of communities

- Provide opportunities and incentives to create social environments in which all generations mix. These could include public or private facilities that accommodate both youth and senior activities, or planning development where adjacent uses allow different generations of the community to interact on a regular basis. By contrast, environments in which one must drive from one daily activity to the next systematically exclude the very young and the very old, who cannot drive and become “involuntary pedestrians” in environments designed for cars.
- Assure access to healthy foods and grocery stores; limit fast food establishments and allow drive-through service only in places where it is in the community’s best interests to have passersby shopping without turning off their engines
- Capture opportunities for farmers’ markets – ideally on streets or within public spaces that are central and part of the local neighborhood street network
- Look for underutilized public space to provide community gardens within neighborhoods, which will encourage gardening and social interaction and provide access to fresh produce
- Integrate exercise routes and equipment into the network of streets, or even within underutilized roadway space (for instance, expanding neighborhood parkways where parking can be sacrificed, or a striped section of roadway that isn’t being used by cars but could be adopted for use by people)
- Promote sustainable planning practices and building design that help to preserve the environment through energy efficient design. Allowing residents and visitors to access the buildings without driving is the foundation of energy efficient design
- Ensure complete bicycle networks and provide amenities within new projects to promote bicycling as appropriate to the scale of the project (bike racks, bike lockers, showers, or even a bicycle station)



*New development should be planned to promote sustainable design and integrate gardens and open spaces that can be enjoyed by residents, or by pedestrians walking by
(Credit: Bridge Housing, David Baker Architects)*

BENCHMARKS

Good land use planning and urban and architectural design are best measured by how they complete the community's vision for the specific place, and how they enhance the daily lives of their residents and users. Other qualitative and quantitative metrics that could be used to evaluate their effectiveness include the following:

- Jobs within a 15-minute commute by public transportation, bicycle, or walking
- Convenience shopping within comfortable walking or biking distance
- A school or park that a child can walk to/from home
- Useful transit within a 10-minute walk from home and/or work
- Clear zoning standards or design guidelines that help assure planning and design will be implemented as envisioned by the community
- Increased land values coming from the effective melding of transit, land use, and design
- The creation of great streets or places that people want to spend time in or live near

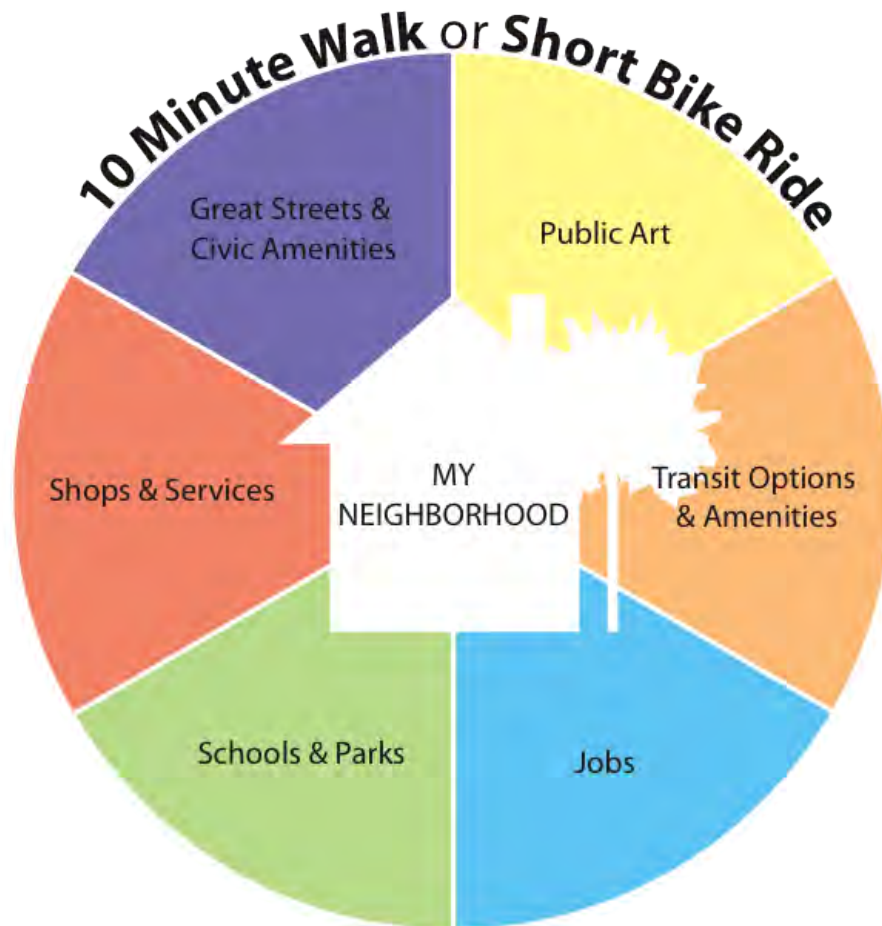

Proximity of amenities in walkable neighborhood (Credit: Cityworks Design)

Chapter 14. RETROFITTING SUBURBIA

INTRODUCTION.....	14-2
TRANSFORMING SUBURBAN STREETS TO LIVING STREETS.....	14-3
Changing Streets without Changing the Right-of-Way.....	14-4
Non-Physical Changes.....	14-6
Street Crossings.....	14-6
RE-ESTABLISHING STREET NETWORKS.....	14-7
SECOND-GENERATION LAND USE ALONG TRANSFORMED STREETS.....	14-7
SETTING PRIORITIES AND PHASING.....	14-10
MODEL PROJECT: BRIDEPORT WAY.....	14-12
ADDITIONAL RESOURCES.....	14-14



INTRODUCTION

Much of suburbia will have to change in order to thrive and meet the health, environmental, and economic challenges of the coming decades. Because of their form, widely separated land uses, and disconnected street networks, most suburban areas lack walkability and require that people travel by car for most of their needs. This has serious environmental consequences (poor air quality, climate change, and high energy consumption) as well as health consequences as suburbanites live in environments that discourage active transportation and favor driving. Residents in these neighborhoods tend to become isolated due to the lack of walkable streets and walkable destinations. Rising fuel costs pinch both family budgets and local economies as people have less discretionary income.

Changing demographics also present challenges. Suburban homes have been built to accommodate young families with children, but fewer households now fit that profile. More and more households are comprised of empty nesters, young singles, divorced adults, and other non-nuclear families, and this trend is expected to grow in the future.

As fuel prices continue to rise and as residents age, suburbs will need to serve more of their residents' needs closer to home, and serve those needs in places that can be reached other than by driving. Suburban areas will need to be retrofitted to accommodate a new reality that rewards places that are close to more people and reachable in many ways.

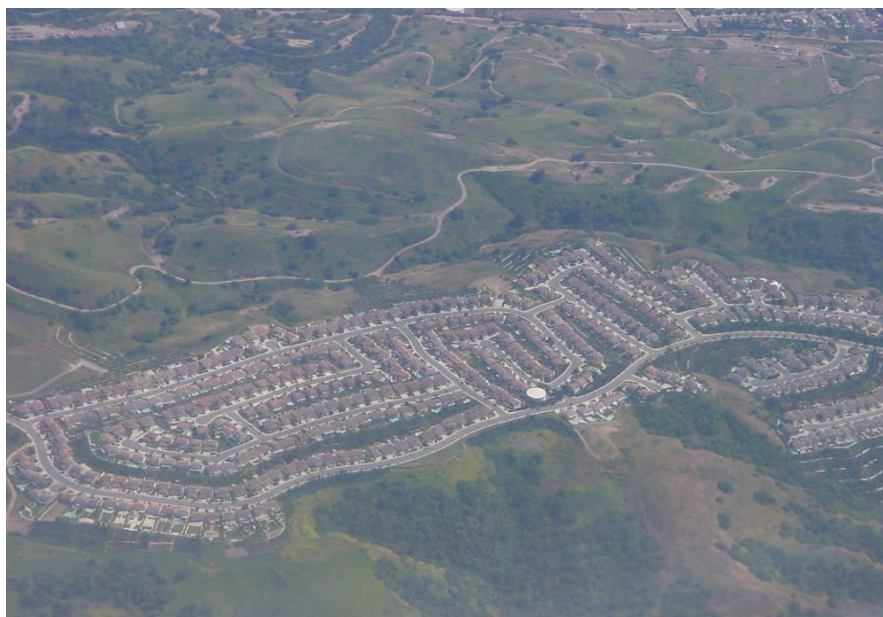

*Suburban development
(Credit: Ryan Snyder)*

This chapter describes how streets can support retrofitting suburbia, provides strategies for retrofitting streets, and recommends priorities and phasing. All of the changes recommended in this chapter will improve safety. The first priority for a city beginning to retrofit itself for the future should be to find and fix the places that are unsafe.



Suburban street
(Credit: Ryan Snyder)

TRANSFORMING SUBURBAN STREETS TO LIVING STREETS

Streets play an enormous role in determining a place's quality of life. Everywhere in the country, people prefer a certain kind of street ("Redefining Charlotte's Streets," Urban Street Design Guidelines, Charlotte, North Carolina, 10/22/2007). People's favorite streets include those with

- An abundant tree canopy and other streetscape features
- Sidewalks and buffering from traffic
- Moderate traffic speeds
- All kinds of uses (walking, cycling, driving, and enjoying the lawns or sidewalks and patios on either side)

People need not know the term "living street" to recognize and enjoy one.

The least favorite streets are those where driveways, parking lots, and utility poles are more abundant than trees and people. They often

consist of wide expanses of pavement for moving traffic, and make little or no provision for any other users. In particular, there is little opportunity to cross the street.

The challenge for cities with too many least favorite streets is to transform them into most favorite, living streets.

Changing Streets Without Changing the Right-of-Way

By definition, a retrofit occurs on an existing street. This manual gives design guidance for all streets, existing and new. The following section recommends how to accommodate those design recommendations on existing streets. Many aspects of living streets actually take less space than typical suburban design.

To create a living street in the right-of-way of an existing street, cities should do the following (LaPlante, J., "Retrofitting Urban Arterials Into Complete Streets," 3rd Urban Street Symposium, June 24-27, 2007, Seattle, Washington):

- Narrow travel lanes. Ten or 11-foot lanes are acceptable for most urban boulevards. They are just as safe as 12-foot lanes for posted speeds of 35 mph or less (Dumbaugh, E., "Safe Streets, Livable Streets," *Journal of the American Planning Association* 71[3] 283-300).
- Seek opportunities to put streets on a road diet; this involves eliminating superfluous travel lanes. Common scenarios include
 - Convert a four-lane undivided road to a center turn lane, two travel lanes, and two bike lanes. This can handle up to 20,000 ADT and improves safety and access to adjacent destinations; the center turn lane can be replaced with short sections of medians and pedestrian crossing islands in selected locations. On-street parking can be substituted for bike lanes where the context and conditions warrant it.
 - Reduce seven-lane roads to five lanes for ADTs of up to 35,000
 - Remove a travel lane from three- and four-lane one-way streets



*Curb extensions with outdoor seating
(Credit: Dan Burden)*

- Tighten corner curb radii to the minimum needed to provide a usable turning radius for an appropriately selected design vehicle. Occasional encroachment by larger vehicles into other travel lanes is acceptable; intersections should not be designed for the largest occasional vehicle.
- Eliminate unnecessary turn lanes at intersections, such as right-turn lanes with very few right turning vehicles. Free-flow right-turn lanes, including freeway entry and exit ramp connections to surface streets, should be replaced with yield control.
- Replace painted channelization islands at intersections with raised islands, to give pedestrians a true refuge, and to break up a long crossing of many lanes into smaller discrete steps.

All of these changes can free up space, which can be used for additional elements. To improve street quality, cities can

- Paint bike lanes
- Add sidewalks
- Add raised medians, which visually narrow the roadway and provide a median refuge for midblock crossings
- Provide median and parkway landscaping, which further visually narrows the roadway and provides a calming effect
- Add or retain curb parking, which improves community access, calms traffic, and buffers pedestrians.
- Add bulb-outs, which shorten pedestrian crossing distances and improve sight lines

Non-Physical Changes

In addition to physical retrofits, cities can and should adapt existing street management and operations to

- Adjust signal timing for slower speeds and to ensure comfortable crossing times for appropriate populations. In areas with aging populations, for example, crossing times may need to be lengthened.
- Work with transit agencies to improve bus operations
- Work with schools to develop a Safe Routes to School Program
- Reexamine the parking code (for example, off-street parking requirements may be reduced, especially in coordination with additional on-street parking)

Street Crossings

A connected sidewalk network includes street crossings. See Chapter 5, “Intersection Design,” and Chapter 7, “Pedestrian Crossings,” for design details. To improve street crossings, jurisdictions can consider the following:

- Make pedestrian crossing locations safe, comfortable, and more frequent (LaPlante, J., “Retrofitting Urban Arterials Into Complete Streets,” 3rd Urban Street Symposium, June 24-27, 2007 Seattle, Washington.)
- Allow crossing at every corner of all intersections
- On streets with a bus route, make provisions for pedestrians to cross the street at all bus stops. Bus riders need to cross the street either coming or going.
- Provide midblock crossings. Pedestrians should not be expected to travel to the closest intersection to cross the street. Signalized intersections in suburban areas are often spaced $\frac{1}{4}$ mile, $\frac{1}{2}$ mile, or even further apart; it is unreasonable to expect people to walk that far to cross the street. Nor do signalized intersections offer safety benefits to pedestrians, due to the many added turning conflicts at large suburban intersections.

Many of these changes can be made through spot improvement programs. Many are relatively inexpensive; it is not necessary to wait for a reconstruction to create a living street. More substantial retrofits may require reconstruction (see the Model Project section at the end of this chapter). A planned surface repaving project is an excellent time to retrofit the corridor to add comfort, convenience, safety, aesthetics, and economic value.



*Midblock crosswalk
(Credit: Dan Burden)*

RE-ESTABLISHING STREET NETWORKS

Chapter 3, “Street Networks and Classifications,” details the need for interconnected street networks with short blocks. Much of today’s suburban landscape was built in isolated pods: residential subdivisions, business parks, shopping centers, and schools that are poorly connected to neighboring properties. These pods create barriers to getting around other than in a car, because they create long distances between destinations and because the pods are often surrounded by sound walls, fences or berms, literally blocking potential bicycle and walking routes. These pods don’t work well for auto traffic either, since they force all traffic onto busy streets rather than allowing connection and local circulation through local streets.

To create a vibrant suburb that will thrive in new conditions, direct connections must be created or re-created to enable efficient, direct travel by everyone. That means establishing or re-establishing street and sidewalk networks.

Re/establishing a street network can be more challenging, particularly when right-of-way has not been preserved. Some cities have purchased homes at the end of cul-de-sac, put the connectors in, and then sold the homes. In cases where a city is still developing suburbs, it should make connectivity a fundamental priority by following the principles in Chapter 3, "Street Networks and Classifications."

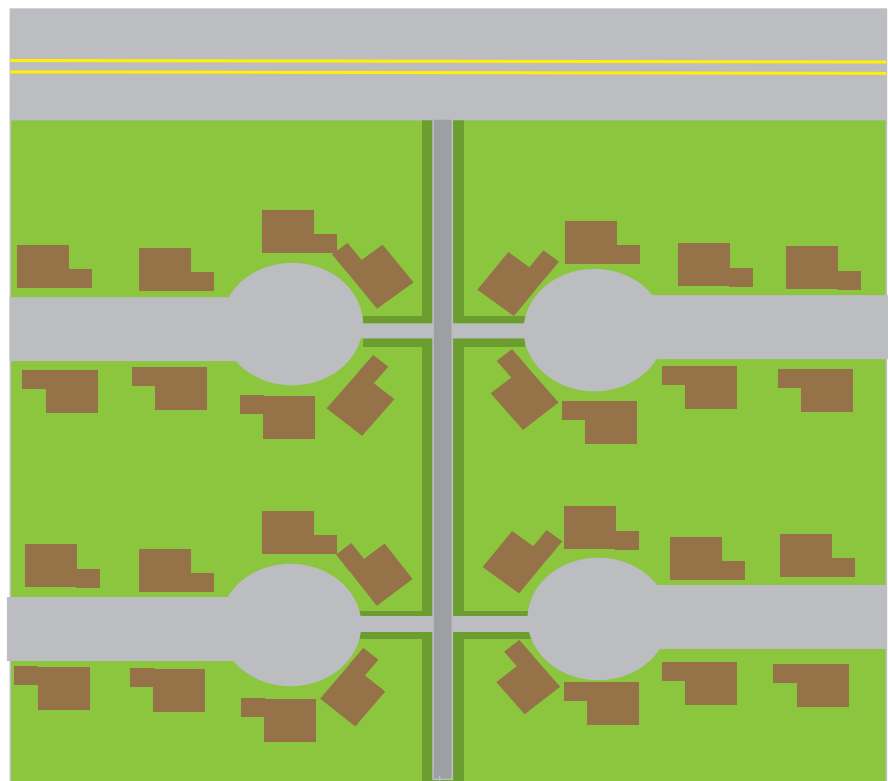

Connecting culs-de-sac (Credit: Marty Bruinsma)



Above, left: Cul-de-sac break up connections. Above, right: Pedestrian networks can be re-established by opening noise walls and connecting new sidewalks (Credit: PB Americas, EWA Connection Study, May 2009)

SECOND-GENERATION LAND USE ALONG TRANSFORMED STREETS

Not only streets will need to change in suburbia; many land uses are obsolete and/or no longer economically viable. However, street improvements generally should come before land use change in suburban retrofitting. This is because high-quality land uses come to high-quality streets. Very rarely will high-quality land uses come to low-quality streets.

The street and the land use work together and determine whether a place is attractive and draws people and investment. To that end, communities retrofitting older suburban areas would do well to use the following three principles:

1. Focus new investment in nodes on streets

In most of suburbia, there will not be enough investment all at once to transform whole corridors. Identify and focus investment at individual nodes.

2. Focus revitalization efforts on creating genuine places in those nodes: compact, mixed-use, and at least internally walkable

Plan for and enable neighborhood-serving commercial districts. Where necessary, rezone from automobile-oriented commercial sites (gas stations, convenience stores, and fast food outlets). These car plazas are designed for, and dependent on, vehicular access and offer no relationships with the nearby residential areas. They absorb retail potential and will tend to discourage development of neighborhood-serving commercial districts.

3. Carefully detail the desired outcomes

It is vital that retrofit efforts pay attention to the details described in the individual chapters of this manual. Adopting well-intentioned policy goals is not enough. There must be follow through by incorporating the vision's details in the design and construction of the project.

Infill development between nodes that follows the principles of this manual will help to connect the nodes into livable neighborhoods.

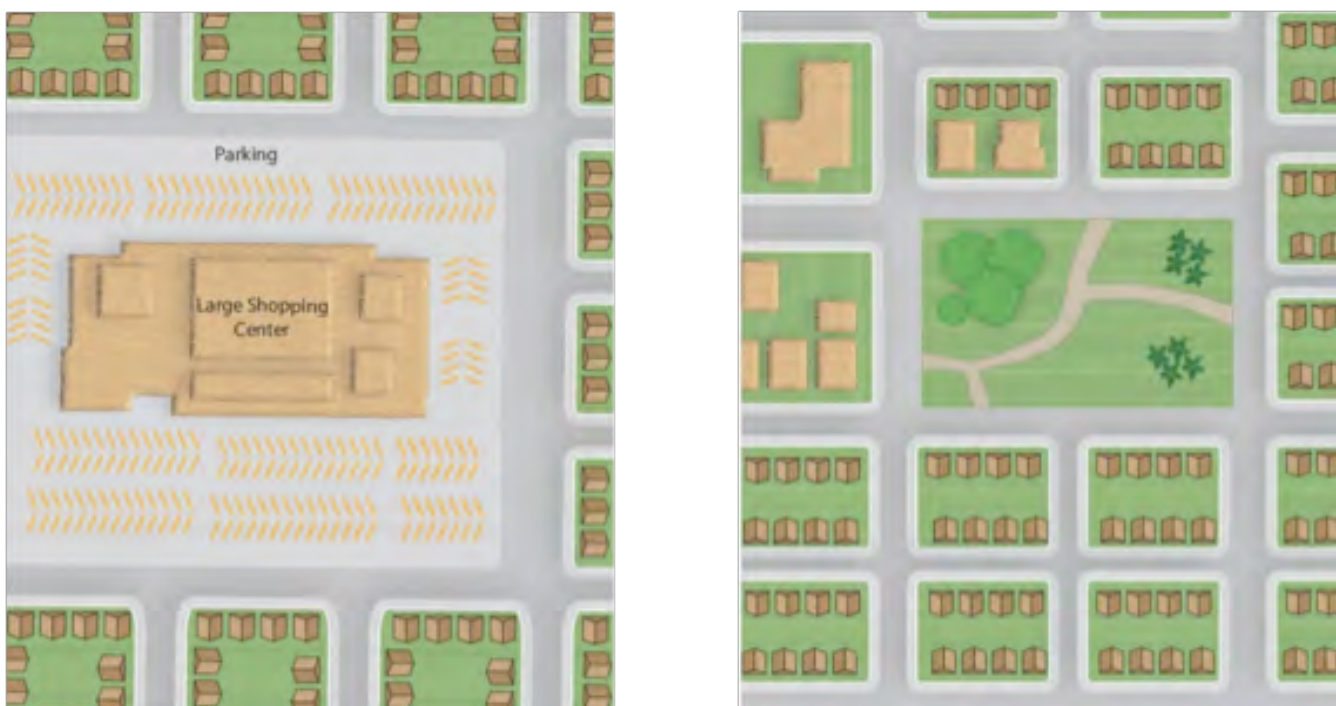

Conversion of shopping center to a neighborhood (Credit: Michele Weisbart)

SETTING PRIORITIES AND PHASING

The primary challenge in retrofitting suburbia is less fixing the infrastructure and more creating economically sustainable places, with the emphasis on place.

As suggested above, the priority should be to begin by creating vibrant nodes. Cities should not allow themselves to be daunted by the scale of the retrofit challenge. As with street retrofits, creating places can be done incrementally. The images on the next page show such an incremental process.

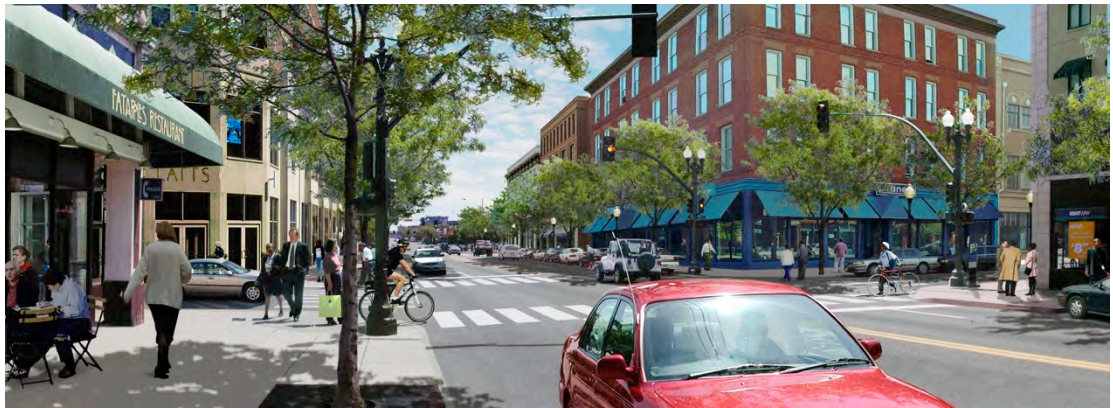

Example of a transformed suburban street (Credit: Urban Advantage, Inc.)

MODEL PROJECT: BRIDGEPORT WAY

Before, Bridgeport Way in University Place, Washington, was a classic auto-oriented suburban arterial street. The existing street had a high accident rate, and did not support economic growth; it attracted neither people nor investment.



Bridgeport Way before transformation: University Place, WA (Credit: Dan Burden)

After reconstruction, the corridor served more people, was far safer, and drew economic development.



*Bridgeport Way after transformation:
University Place, WA
(Credit: Michael Wallwork)*

Safety improved significantly:

- 7% speed reduction (35.3 -> 33.4 mph)
- 60% crash reduction (19 -> 8 in five blocks)

Bridgeport Way illustrates the principle described above of leading with a street retrofit, then following with bringing higher-quality land uses to the now high-quality street.

The City of University Place identified empty, redevelopable space along the corridor and at intersections. The photo below shows ample space that has been used for parking, building setbacks, and other uses.



*Bridgeport Way transformation opportunities: University Place, WA
(Credit: Michael Wallwork)*

The City planned for new development that would create a new place, as shown in the rendering below.



*Bridgeport Way plan: University Place, WA
(Credit: City of University Place)*

ADDITIONAL RESOURCES

ICF International with Nelson\Nygaard Consulting Associates and Reid Ewing. *Transportation Study of the U.S. Route 1 College Park Corridor*, July 14, 2008.

PB Americas, EWA Connectivity Study, May 2009.

Dunham-Jones, E. and Williamson, J., *Retrofitting Suburbia: Urban Design Solutions for Redesigning Suburbs*, John Wiley & Sons, 2009. This book focuses more on retrofitting parcels of land, rather than on the streets between them. Nonetheless, it is an excellent resource.

Chapter 15. COMMUNITY ENGAGEMENT FOR STREET DESIGN

INTRODUCTION.....	15-2
ESSENTIAL PRINCIPLES OF COMMUNITY ENGAGEMENT.....	15-4
Develop a Plan.....	15-4
Accept Responsibility for Success.....	15-5
Start with a Base of Shared Values and Build Understanding.....	15-7
Broaden the List of Stakeholders.....	15-11
Foster Cultural Competence.....	15-15
Expect Emotional Connections—and Reactions—to the Built Environment.....	15-16
Approach Engagement as a Two-Way Conversation.....	15-17
Achieving Informed Consent.....	15-18
Carry the Momentum Forward.....	15-20
CONCLUSION.....	15-22
ADDITIONAL RESOURCES.....	15-23



INTRODUCTION

Effective community engagement is critical when developing policies and projects that make a community's built form more livable and more supportive of active transportation. There are many benefits of effective community engagement in projects influencing the built environment, be they urban, suburban, or redevelopment projects.

Effective community engagement improves the success rates of policies and projects affecting the built environment because it helps the agencies and organizations leading a project understand and respond to local conditions. Agencies that create true community engagement are more successful at adapting to socio-economic changes that may influence the effort than those that do not conduct effective outreach (Cogan, E. and Faust, S., *Innovative Civic Engagement Tools and Practices in Land Use Decision-Making*, April 2010). When people affected by a project are involved from the beginning of the planning process, the likelihood of unexpected or significant opposition when it comes time to implement the project is reduced. Community members also have unique knowledge of local contexts, including political, cultural, and geographic settings. By interacting with the public and gaining local insight, project leaders can shape and direct the project in keeping with the community's vision and needs.

Effective community engagement also has the power to build social capital—the “social networks and interactions that inspire trust and reciprocity among citizens” (Leyden, K., “Social Capital and the Built Environment: The Importance of Walkable Neighborhoods,” *American Journal of Public Health*, 2003, 93[9]:1546–1551). A community with a high level of social capital is characterized by a culture of neighbors knowing each other, interest and participation in local politics, high rates of volunteerism, and diversity in social connections. These characteristics foster a sense of community, engender trust, enhance innovative problem solving, and increase the likelihood that stakeholders will support financial investments in community projects.

Research has demonstrated that a population can achieve long-term health improvements when people become involved in their community and work together to effect change (Hanson, P., “Citizen Involvement in Community Health Promotion: a Role Application of CDC's PATCH Model,” *International Quarterly of Community Health Education*, 1988-89; 9[3]:177-186). Thus, even before projects are fully developed, creating a strong community engagement process sets the community on a path toward improved health. Effective community outreach also helps address unequal access to health, including issues



*Public workshops should involve people in the planning process
(Credit: Dan Burden)*

such as active living. Health equity, or the fair distribution of health determinates, outcomes, and resources regardless of social standing, is affected by factors such as poverty, housing, language, quality of education, and quality of healthcare. Through successful community outreach, people of all backgrounds and social standing are able to contribute to projects that support health and well-being. They also can help project leaders better understand how social, cultural, and economic barriers that impact historically disadvantaged communities are relevant to improving community health and well-being.

This chapter reviews principles and strategies to engage communities, including developing a plan for reaching out to communities, broadening the list of community stakeholders, fostering cultural competence, and achieving informed consent.

ESSENTIAL PRINCIPLES OF COMMUNITY ENGAGEMENT

A conventional model of “public involvement” has been built around complying with legal requirements for issuing public notices about projects and related events, holding public hearings to solicit feedback, and incorporating feedback into draft recommendations. The community has been invited in when project leaders have decided input is needed—or when it is mandated by law—and the public hearings, citizen advisory councils, and public comment sessions have formalized the effort. At many public meetings or events, a classroom structure communicates to people that they are to listen and not converse. This model fails to truly engage the public.

Given the many benefits offered by true community engagement, it is clear that project leaders, policy-making bodies, government agencies, health agencies, and community organizations have a special obligation to develop an inclusive approach to outreach. To engage communities, leaders must move from the conventional model to one that focuses on outreach, capacity-building, inclusiveness, and collaboration. Employing the following principles and strategies will help.

Develop a Plan

Project leaders shouldn’t begin a public process without first developing a thoughtful and thorough community outreach plan that describes the desired outcomes of the project, and details the public process, including who the stakeholders and audiences are, how they should be reached, the messages to garner interest and tools that will be most effective in reaching them, and how the success of the effort will be measured. The plan should describe how outreach efforts will help build capacity, promote a shared language, illustrate project benefits, and inspire participation.

In general, community engagement activities need to address issues that the public perceives as important. Thus, while developing the community outreach plan, project developers should seek ways to explain to the public why the project matters. Additionally, efforts should be made to conduct workshops, events, or meetings in places that are comfortable and familiar to the audiences, and to use language that is clear. Each communication or event should contribute to the public’s understanding of the project and its purpose.

This chapter does not provide a template for a community outreach plan; it provides general guidance to help project leaders understand important principles and methods of achieving community engagement. With this guidance, a community outreach plan can be developed that utilizes best practices to accommodate local contexts and support community needs in working toward the goal of the project.

A community outreach plan should at the very least describe the project, the goals of the outreach effort (definition of success), identified issues, target audiences, messages that are meaningful and relevant to the audiences, distribution channels, key messengers or speakers, resources available, tools, timelines, desired outcomes, and methods of evaluation and adjustment.

Specific outreach tools may include educational workshops, media outreach, paid advertising, surveys, print materials (such as flyers and brochures), PSAs, educational videos, slide presentations, charrettes, newsletters, websites and other online communications, social media, direct mail, letters to the editor or guest commentaries, councils, speakers' bureaus, partnerships, coffeehouse chats, meetings, interviews, demonstrations, bulletin boards, and more.

Accept Responsibility for Success

Project leaders must take responsibility for developing effective and successful outreach programs that achieve identified goals. Too often, blame for a failed public process or event—one at which the turnout is disappointing, for example—is placed on public apathy. In many cases, though, the outreach effort was inadequate or misdirected. Sometime, the messages simply fail to convey why community members should care to participate in the process. For example, a conventional public notice may announce that the public is invited to a public hearing to comment on a proposed transportation plan. By contrast, a more meaningful outreach message would be that community members' input is needed to shape the community's future; the announcement would speak of streets, sidewalks, trees, and parks, would explain that transportation systems are integral to community-building, and would request residents' help to determine what their community should become.

If truly effective community outreach was conducted and the public still showed little interest in the process, then the value of the project to the

Chapter 15. Community Engagement

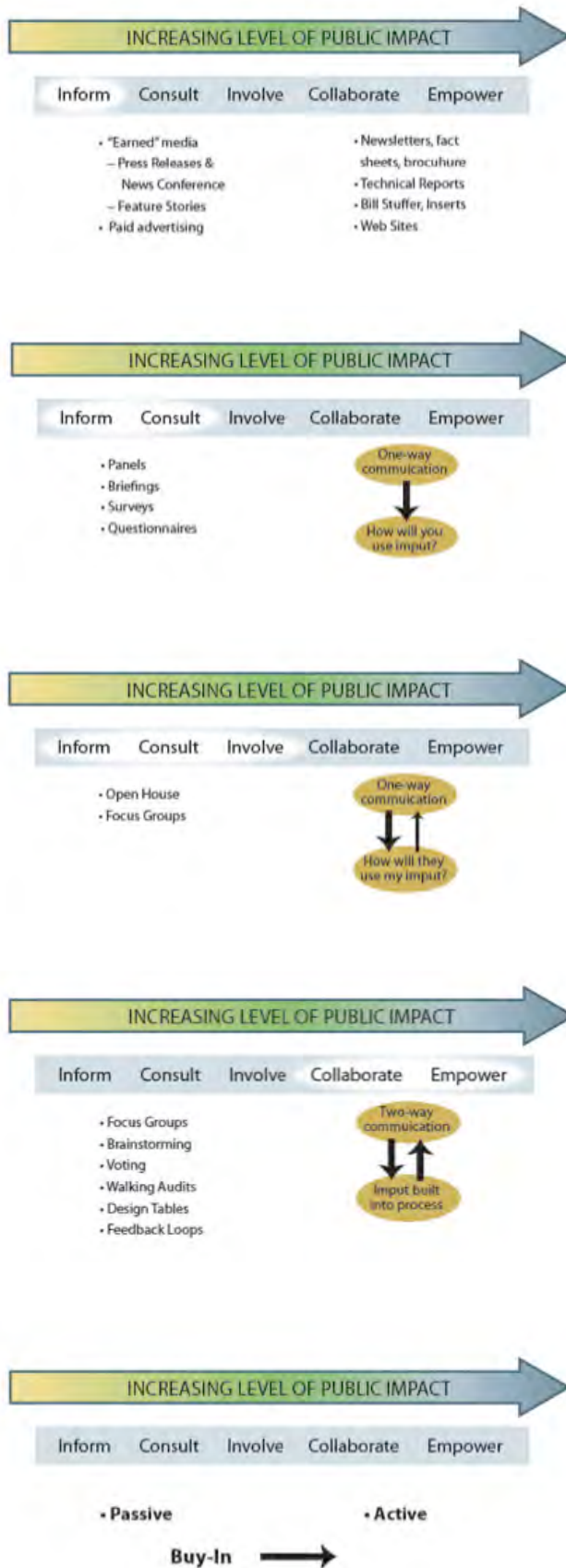

public must be revisited. If, on the other hand, project leaders understand the project truly is important and the public simply hasn't engaged, then the effectiveness of the outreach effort must be revisited. Were the messages meaningful to the identified stakeholders? Were events held at convenient and comfortable times and places? Did people perceive the process as interesting, simple, important, or relevant to their lives? Did the messages even reach the target audiences?

A third consideration is that failure and success haven't been properly defined. For example, sheer numbers of participants may not be an appropriate measure of success. In a small community, an event turnout of 15 people who represent diverse interests, are truly interested in the project, and learn something from or contribute to the process may be a much more successful outcome than a roomful of 75 people who leave the event disengaged or who didn't find an opportunity to contribute in a meaningful way. Appropriately defining success and failure of a public process is an important part of developing a community outreach plan.

When defining success and failure, consider whether the community engagement effort should be designed to

- Inform: community members are informed about the project but aren't actively involved in the process.
- Consult: the public is asked to provide feedback on analyses, alternatives, and decisions.
- Involve: feedback loops allow community members to influence multiple stages or drafts of the project.
- Collaborate: the public is a partner in each phase of the decision-making process and provides direct advice on solutions.

- Empower: the final decision is in the hands of community members and the project leaders will implement what the community chooses. Care is taken to ensure that the community is educated about approaches that work for all people, that key participants will help spread the word throughout the community, and that community members will play an active role when issues come before policy or decision-making groups such as councils and commissions.

Outreach programs that most actively engage and empower the public also lead to the highest levels of buy-in and build the greatest support, which help alleviate some of the pressure on staff and elected leaders.

Start with a Base of Shared Values and Build Understanding

The traditional model for public involvement in projects that affect the built environment often engages the public too late in the process, and in a manner that pits interests against each other. For example, holding a standard public hearing on a proposed project sets up stakeholders to take a position either for or against the project, without any discussion about community values and whether the project supports those values.

A better model is to start the public process with visioning sessions or educational workshops that identify or clarify shared values. In some communities, a vision plan already exists and in those cases, the vision plan should help guide the project development. In other communities, a simple values-clarification exercise during an initial public workshop can go a long way toward helping stakeholders see that they generally want the same things for their streets—safety and security, economic development, attractive sidewalks, landscaping, and so on—and that their goal should be to collaborate on ways to achieve those ideals through the project being developed. Values clarification also can provide useful guidance to policy makers when trade-offs are concerned, for example, when the potential long-term effects of a decision are measured against short-term gains or losses. Starting with a base of shared values helps ensure outcomes aren't predetermined, but that the local vision is driving the process.

Facing page (15-6): Credit: Michele Weisbart, adapted from the International Association for Public Participation.

From this base of shared values, strive to build understanding and knowledge. Think like an educator, use language that is familiar and clear to the audience, and encourage reciprocal learning (learning

from each other) and experiential learning (learning by doing or experiencing). Frame issues neutrally to maintain credibility and to ensure participants can make informed decisions. Facilitate well-informed and well-rounded discussions that ensure all voices are heard.

Toolbox: Active Workshops and Design Charrettes

The conventional format for public involvement usually doesn't build community interest, can be downright boring, and fails to capitalize on opportunities to build social capital through the process or engage people in reciprocal learning. Even workshop formats that aim to be more educational can fall short in efforts to build a shared understanding of the issues being addressed, or in making the participants feel truly engaged in the process.

Two tools being used by more and more communities throughout the country are active workshops and design charrettes.

Active, or experiential, workshops get participants out into the community to explore firsthand what shortcomings exist and how to improve upon those conditions. Active workshops include educational presentations, but focus on active learning and firsthand experience. Active workshops don't have to be long events. A successful one can be as short as three hours, if planned well.



Design charrette engaging stakeholders (Credit: Dan Burden)

Charrettes are collaborative sessions to solve design problems. Charrettes usually involve a group of designers working directly with participants to identify issues and create solutions. A charrette can be one day, several days, or weeks. A charrette conducted as part of a public process for a street should include educational activities (such as short presentations and walking audits, sharing of expectations and desired outcomes, priority setting, mapping exercises during which participants break out into small groups and mark-up maps with potential challenges and opportunities) and building consensus or informed consent for a proposed solution or set of solutions. Charrettes create a collaborative planning process that harnesses the talent of residents, townmakers, community leaders, and public health officials alike. At the end of the charrette, project leaders present the outcomes and findings to stakeholder groups and to the public.

Getting all the right people together for a design charrette is essential to ensuring that the outcome reflects the values and goals of the community. People from all sectors of society with diverse backgrounds are needed at a charrette, including local government officials, planners and designers, landscape architects, transportation engineers, nonprofit managers, public health officials, and of course, residents.

Even with engaged and motivated participants from all relevant backgrounds, the charrette still may be missing a group that can provide valuable insight about how to design a healthier and happier community: children. Children's charrettes can bring valuable stakeholders in that might not otherwise be able to participate. They also provide the benefit of a unique perspective. The chief objectives in a children's charrette are for it to be fun and engaging. Work with schools, parks and recreation departments, and parent/teacher associations to identify the best venue for engaging children and to conduct the needed outreach to ensure children attend. Also make sure children's charrettes are age appropriate.

Effective active workshops and design charrettes help build social capital in the community. When people are taken outside of a classroom or presentation structure and are put in an environment, such as designing around tables or walking along streets to evaluate the built environment, where they can converse freely and naturally with others, many shared interests and connections emerge. This can foster partnerships that cross real or perceived boundaries, such as differences in generation, culture, socio-economic status, or geography. Effective workshops and charrettes often dedicate time toward the beginning



South Gate Bicycle Plan Workshop Flier (Credit: City of South Gate)

of the events to help participants get to know each other through ice-breaking exercises that ideally will lead to long-lasting relationships.

Planning and conducting successful active workshops and design charrettes requires attention to the following details:

- Engage key partners early. Identify community-based organizations, government agencies, healthcare providers, employers, school boards, the media, and other organizations whose members or stakeholders may have an interest in the topic. Engage transportation, planning, emergency services, public health, and public works entities early in the planning process, and then enlist their help to conduct outreach and to issue invitations.
- Choose the right audit site. Work with the key partners to identify an audit site that captures the essence of changes needed throughout the community, or one that will have the greatest impact or has the potential to become a model project and serve as a catalyst for other projects.
- Consider comfort and abilities. Give careful consideration to participants' comfort and abilities. Everyone who wishes to take part should be able to do so, and any special needs should be accommodated. Also, if the event is held during hot or cold months, conduct outdoor portions during the most comfortable time of day. Accommodate the needs of participants: for example, providing food allows working people to attend a 7 p.m. workshop; parents may need an organized play room for children too young to participate in the workshops.
- Encourage relationship-building and provide a next step. Effective workshops and charrettes will motivate and inspire those who take part, and many will be eager to contribute their energies toward enacting change. They will need to draw upon each other's strengths, stay in contact, offer each other support, and share information to undertake the important work to be done. Encourage them throughout the event to network with each other and exchange contact information. If possible, form a "working group" and decide upon a first meeting date; invite people to opt in.

In particularly successful workshops and charrettes, project leaders can stand back and observe while residents pore over maps, draw



*Involve all types of stakeholders
(Credit: Dan Burden)*

meaningful new lines, find ways to improve access to healthy eating and active living, and generally work together toward a shared vision. Project leaders will need to provide technical guidance, but the community can and should make choices about the future together.

Broaden the List of Stakeholders

To build effective community engagement, project leaders should broaden the list of stakeholders and partners whose involvement is sought. The overarching goal should be to achieve diversity by involving a demographically and geographically balanced group of people representing various interests and backgrounds.

Stakeholders and partners commonly include city and county staff, advocacy groups, residents, business operators, property owners, elected officials, community leaders, neighborhood safety groups, emergency responders, school representatives, health agencies, “Main Street” or downtown groups, charitable non-profit organizations, and regional employers. To be more effective, project leaders also should seek the early involvement of faith-based organizations, news outlets, potential opposition groups, and seasonal residents.

In every community, there are people and groups that serve unique roles or have connections built on local context or events. Project leaders should determine who they are and invite them into the process early.

Faith-Based Organizations

Across the country, churches, “build and sustain more social capital—and social capital of more varied forms—that any other type of institution” (Better Together, The Report of the Saguaro Seminar: Civic Engagement in America, Harvard University’s Kennedy School of Government, 2011). In small towns or areas of sprawl, churches, temples, and mosques often serve a major role in building community and capacity for change. Thus, project leaders should seek innovative ways to work with church leaders to engage their membership in public projects.

Potential Opposition Groups

Special efforts should be made to identify and reach out to people and organizations that may be expected to oppose the project, to build their trust and involvement. Try to identify and address their concerns both as part of the public process and during special stakeholder interviews or meetings. This may include internal groups or professionals who initially may be inclined to provide technical brush-offs. For example, they may at the outset be worried that sanitation trucks won't be able to maneuver on narrow roads, that trees may disrupt drainage, or that a crosswalk isn't needed where people don't already try to cross the road.

Whether internal or external, these concerns should be addressed early in the public process to give the potential opposition time to understand the project, become comfortable with proposed solutions, ask many questions, and decide whether to support the effort. Support is much more likely when these individuals and groups have been invited into the process early and have been included as key stakeholders. If participants feel as though the outcome is their plan, they are less likely to oppose it. By working side-by-side with other stakeholders, they learn to appreciate and accommodate others' points of view.

Moreover, opposing groups often bring legitimate concerns to the design process. Through their involvement they can improve projects.

Seasonal residents are often ignored because they are often not viewed as a true part of the community; they include migrant workers, resort residents, members of the military, and merchant marines. Although their members may not be able to attend public events in person, representatives of seasonal residents (including organizations such as migrant worker education groups, healthcare providers, homeowners' associations, property managers, military officials, and operators of ports, marinas, and resorts) can become liaisons between their constituents and the project leaders, and are well positioned to share timely and important information both ways.



*Children at workshop
(Credit: Dan Burden)*

Children

Children have much to offer in the community planning and design process, yet they remain mostly untapped throughout community transformation processes. A child's imagination is a powerful tool;

children can dream the perfect community in which to live, play, and go to school. Beyond the power of their imaginations, they can also bring very practical solutions to the table. For example, children are often aware of shortcuts that could be formalized into trails and added to the community's pedestrian network map. Their values and honesty helps raise the discussion to the level of guiding principles; the involvement of children in public processes can change the whole tenor of the event. Engage children through children's charrettes, art or urban design contests, school field trips, and special activities at community charrettes or workshops. Invite them on walking audits near their schools. At the very least, provide schools with flyers announcing the project or public process that can be sent home with children in their bags.

Toolbox: Media Outreach

Conducting effective outreach to news outlets is important to the success of any community engagement effort. The news media are more than simply a means to get the word out about the project. Rather, project leaders should try to build capacity among news organizations, just as the outreach effort seeks to build capacity among community members; building relationships with reporters helps ensure the general public is receiving accurate, timely, and meaningful information about the project.

The lead agency's communications department should be consulted to provide guidance, expertise, and tools, but project leaders should remain very engaged in the media outreach effort. Project leaders should be committed to working within the agency's communications protocols, such as complying with a gatekeeper policy if one exists. If a communications department isn't available, the following paragraphs provide general guidance.

Call Key Outlets Early

As soon as the project kickoff is confirmed or possibly even earlier, call—don't email, fax, or send a letter—key reporters to share the purpose of the project and to ask them how best to provide more information when it is available. Keep a list of the contacts made and how they would like to receive additional information; then, be sure to follow up in that manner.

Depending on the news organization and its depth and structure, special

effort should be made to reach transportation, public safety, and health and business reporters. Contact the primary news sources in local and regional markets, but don't overlook non-traditional news sources, such as blogs that cater to cyclists or that address transportation, public safety, community health, retirement, and business issues. Any key reporters—regardless of their medium—should be contacted as soon as possible by phone.

Also, offer to submit a guest commentary in advance of the project kick-off or to secure a prominent guest for an upcoming talk show. If the project may be especially controversial, try to schedule an editorial board meeting with the local or regional paper.

Issue Meaningful News Releases

Develop a news release that is engaging and written in the form of a news story. Be sure to include the five W's—who, what, why, when, and where. Describe the goal of the project, how people can become involved, and any other information that will help make the story meaningful and relevant to the local and regional audience. Include keywords to ensure the news release and its contents can be easily found online. Distribute the news release initially to the key media outlets already contacted, and be sure to provide it in the manner they requested (check the list made during the initial conversations). Then, distribute the news release to all other media outlets in the region. Also, consider including non-traditional news sources in the media outreach strategy.

Finally, distribute the news release to local partners and other local contacts, asking them to share it with their media contacts. The value of the relationships the local partners already have with media contacts shouldn't be overlooked; tap into that value by supporting the local partners in their efforts to conduct media outreach for the benefit of the workshop and related efforts.

Be Responsive and Keep in Touch

As project leaders build relationships with news sources, they should expect to receive more and more inquiries. Understand that reporters often are working on very tight deadlines; sometimes they receive story assignments mid-day with evening deadlines. Be responsive and provide timely information to help ensure accurate details are relayed to news audiences and to further support the relationship with the reporter. Additionally, be proactive in sharing news about project developments or milestones being met; doing so will further build capacity amongst

the news sources, help keep them engaged in the project, and support the dissemination of timely and accurate information.

Media as Stakeholders

Conventional community outreach plans have treated the media as a means of simply disseminating information. A more effective approach is to engage members of traditional and non-traditional news outlets alike (newspapers, television, radio, online news services, bloggers, etc.) as stakeholders and seek their involvement early in the process. Just as project leaders should build capacity amongst residents and within the community, so too should they seek to build capacity with journalists and news outlets. The media can also help projects move forward with positive editorials and favorable reporting.

Foster Cultural Competence

Ensuring that programs and messages are designed to be relevant, appropriate, and effective in different cultures and different languages is vital to conducting successful community outreach. In fact, cultural competence has emerged as a key strategy to improving health and the quality of healthcare and social services for everyone in the U.S. regardless of race, ethnicity, cultural background, or language proficiency.

Translating important messages requires strong cultural knowledge, because “simply replacing one word with another won’t do”



Stakeholders share the planning responsibility (Credit: Ryan Snyder)

(Zarcadoolas, C. and Blanco, M., “Lost in Translation: Each Word Accurate, Yet...,” *Managed Care Magazine*. August 2000). But reaching people of all backgrounds often requires more than simply translating messages. Even in urban communities, but especially in rural areas or small towns, messages perceived to have been created by “outsiders” can actually do more harm than good by creating discomfort or mistrust.

To increase their effectiveness, many organizations working with multi-cultural populations are developing “ambassador” programs that recruit people who live in and work in a community to be community educators and liaisons between the project or program and the community. Other communities are working to culturally adapt messages, instead of simply translating them, to focus on types of behavior changes that would be relevant and appropriate in the cultural context of the different audiences.

When culturally adapting messages, consider the following:

- Language doesn’t equal culture. Although a shared language is important to culture, people who speak the same language often are from different cultures. Be sensitive to the differences and develop appropriate messages.
- Start with strong cultural knowledge. Tap the knowledge of in-house staff or consultants who live, work, or grew up in the culture.
- Get feedback. Work directly with members of the audience to determine appropriate approaches. Use focus groups to screen messages before they are distributed.

Expect Emotional Connections—And Reactions—To The Built Environment

People have strong emotional connections to their built environments, and those feelings influence involvement in community-building efforts. The structures and infrastructure around people create strong frames of reference for daily living and help build comfort, a sense of security, and a sense of belonging.

Place attachment is a notable part of daily life. Project leaders should anticipate that responses to projects may be emotional, but those responses shouldn't be dismissed as invalid; they should be addressed as valuable input.

Approach Engagement as a Two-way Conversation

Effective public engagement involves more than telling people about a project; effective engagement facilitates a dialogue that leads to reciprocal learning, collaboration, and ideally, consensus.

Community members have unique knowledge of local contexts that will affect the outcome of a project development process. By engaging in reciprocal learning, project leaders will gain insight and perspective that can help them ensure the project is tailored to meet the community's needs. Community members also will learn from each other.

An effective public process results in people feeling that they are well-informed and that they've had opportunities to contribute throughout the stages of decision-making.

"In fact, what appears to be most important from a citizen's perspective and from the standpoint of attaining ongoing engagement is not the strategy employed, but how government responds when citizens voice their preferences. For citizens, there are two questions that are paramount: Did the government listen and take action based on what they heard from us? Was it worth my time and effort?" (Connected Communities: Local Government as a Partner in Citizen Engagement and Community Building, Alliance for Innovation, Oct. 2010).



Product of design charrette (Credit: Ryan Snyder)

In addition to workshops, project leaders can seek community input through interactive online tools such as websites, digital storytelling, and community mapping. In communities with many seasonal residents, these tools can be especially useful in collecting input from stakeholders who aren't able to attend events in person.

Digital storytelling allows the public to use photos and presentation tools to illustrate concerns about the built environment. Many communities are starting to use this "photo voice" approach to encourage community members to present their points of view using photographs and descriptions or narration. The package can be submitted electronically to project leaders or presented as part of a public workshop or event.

Achieving Informed Consent

The goal of informed consent is not compromise, where everyone must give up something. Informed consent is based on the assumption that most people will give their consent to a change, even when it is not in their personal best interest, after they have been engaged, become informed, and see the value to their community. Although this requires altruism, there are many reasons why it succeeds other than people wanting to leave something behind as a legacy. Working cooperatively, all people achieve more, and so enlightened self-interest wins, once people understand why an idea is good for their neighborhood.

The steps of the informed consent process are as follows:

- **Desire.** The public process comes about as a result of a community coalescing around a desire for a change in its built form. Though desire comes in different forms, it is the necessary energy and often passion used to steer the project towards a sustainable and community-oriented outcome.
- **Discovery.** Discovery is the process of developing a complete and common understanding of the situation, context, and the built vision by the design team and the stakeholders. Context is a short form for the physical, social, historical, fiscal, environmental, political, and climatic contexts. Good discovery is done by
 - Listening, looking, and involving people



Stakeholders designing their streets
(Credit: Dan Burden)

- Visiting, reading, and probing
- Educating and exploring physically and intellectually
- Design. Design is the employment of people, their related skills, and what they discovered to produce products that articulate, memorialize, and motivate people towards the consensus outcomes and the vision. It tends to be the most exciting part of the process. This is when collaborators can raise the bar in terms of creativity and sustainability.
- Discussion. Discussion happens throughout and requires the right people/stakeholders with the capabilities present at the right times in order to maximize short feedback loops. It is the discussion phase that builds and overcomes uninformed decision making. If grassroots planning is to work, people must become informed on what helps build a community. With the combination of a strong desire and community leadership the sense of frustration will be overcome, but this must come with an informed neighborhood. Discussion involves
 - A series of presentations to raise stakeholders' knowledge
 - Testing/viewing the design and parts of the design from a variety of perspectives
 - Circling back to alter parts that need altering
 - The project manager must prepare the community to "sell" its vision to others. True ownership of a vision comes from within.

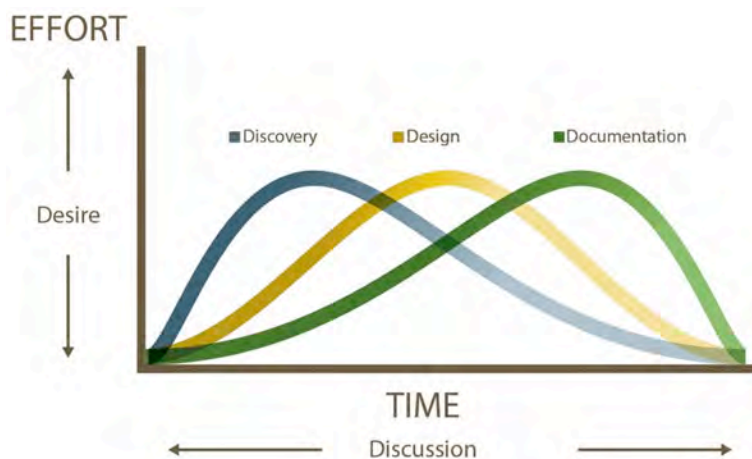

Steps of the informed consent process (Credit: Michele Weisbart, adapted from Ian Lockwood)

Steps of the informed consent process (Credit: Michele Weisbart, adapted from Ian Lockwood)

- Documentation. Documentation starts at the beginning of the project but the effort is highest towards the end when the products are finalized. Example products include documents, posters, codes, speeches, agreements, construction drawings, and advice. This documentation works best when designers anticipate pushback. Messages must be clear, concise, comprehensive, and attractive to draw people in.

Carry the Momentum Forward

Successful community engagement often leads people to become motivated and ready to mobilize to enact positive change. Project leaders should capitalize on this energy and help form long-lasting coalitions by organizing a working group or advisory council that will help carry the momentum forward. The members of the group should represent diverse interests and backgrounds and should be committed to continuing to communicate with each other and meeting regularly to address the issues identified through the project development process. The group can be established to provide guidance and continuing community feedback to project leaders as implementation begins.

Celebrating early successes helps ensure long-term project success. When project implementation begins, identify an early achievement and widely publicize the success; this can even be the project's public process itself. Consider holding a special event that will publicize the



*Community celebrates and supports their achievements
(Credit: Michael Ronkin)*

new community asset, bring recognition to the people involved, reaffirm that the process has worked, and build more support for work to be done. For example, the completion of a trail or trail segment could be celebrated with a special family fun run/walk held in conjunction with a ribbon-cutting ceremony and press conference. Widely celebrating projects like these helps people in nearby communities envision how they can improve their neighborhoods as well.

Toolbox: Strategies for Implementation

The following strategies can be helpful in implementing projects:

- Secure and leverage the support of key partners early. They may be members of the chamber of commerce, influential elected leaders, chief planners of agencies, or community advocates. Leverage their support by ensuring other key partners are aware of their buy-in.
- Use data appropriately. Too many towns don't implement projects because they lack data, or conversely, they rely on it too heavily. Presented with too much, people may argue over its meaning, leading to projects not being built and community members losing trust in project leaders. Some data is needed to ensure the context is properly understood. Thus, conducting research to collect basic data is necessary, but street design projects also should be driven by commonly held values in the community.
- Build model projects. Model projects can be examples of how streets can work better, especially when building something that is new for the community, such as a non-conventional crossing, a road diet, reverse-in angled parking, mini-circles, or roundabouts. Build model projects first in areas with strong backers and the greatest chances for success. If the vision is to have modern roundabouts in a dozen locations, start with the location with the most enthusiasm and support. Enlist local leaders to attend meetings, submit letters to the editor, and conduct other outreach that explains why the neighborhood wants the new feature.
- Evaluate built projects. Don't just build a project: evaluate it. For example, a 30 percent increase in people walking, 20 percent more bicyclists, a reduction in vehicle speeds of 7 mph,

120 column inches of positive newspaper coverage, and other metrics can validate the project and build support for similar projects. Use other performance-based measures to evaluate success not only of the project, but also of the public process that led to it. Evaluations can assess the assumptions and the planning processes that lead to changes. Assessment of the planning process includes evaluations of how well the project performed. Evaluation can include the following:

- Did the project meet the commonly-held community vision?
- Important projects that benefit all members of the community are the first to be built. Did those built reflect the community's priorities?
- Did the project provide long-term benefits to all people?
- Did the process allow for adequate time to respond to plans?
- Were there any legal actions or complaints about the public process that could have been reduced or eliminated?
- How can the public process improve?

CONCLUSION

Creating successful community engagement through effective outreach is a significant investment of resources, but many of those resources already exist in-house and simply need to be committed to the effort. For policy-making bodies, government agencies, health agencies, and community organizations that understand the value, benefits, and processes of creating successful community engagement, the effort provides a clear return on investment.

ADDITIONAL RESOURCES

Betancourt, J., Green, A., Carrillo, J.E. and Park, E.R. 'Cultural Competence and Health Care Disparities: Key Perspectives and Trends.' *Health Affairs*, 2005, 24(2):499-505.

Ikemoto, L. "Racial Disparities in Health Care and Cultural Competence." *HeinOnline* 48 *St. Louis U. L.J.* 75 (2003-2004).

Tri-County (Colorado) Health Department and Communities Putting Prevention to Work. *Built Environment and Health Handbook*. January 2011.

Manzo, L. and Perkins, D. "Finding Common Ground: The Importance of Place Attachment to Community Participation and Planning." *Journal of Planning Literature*. May 2006, 20(4):335-350.

Federal Highway Administration, *Public Involvement in Transportation Decision Making*. <http://www.fhwa.dot.gov/reports/pittd/charrett.htm>

APPENDIX: VISIONS OF TRANSFORMING STREETS



MODEL DESIGN MANUAL for Living Streets

Appendix

The photosimulations on these pages present images of how streets can be changed to make better places and neighborhoods. The simulations show the application of principles and concepts described throughout this manual.





Credit: Todd Clements





Credit: Todd Clements



Credit: Dan Burden



Credit: Alexis Lantz



Credit: Marty Bruinsma



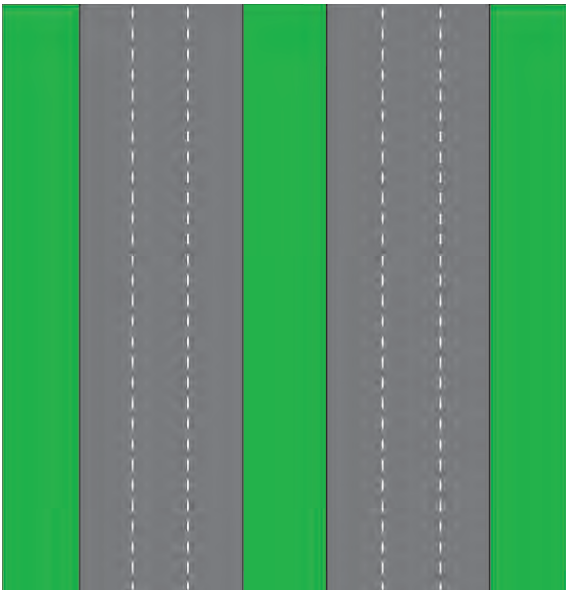

Existing San Vicente Blvd.

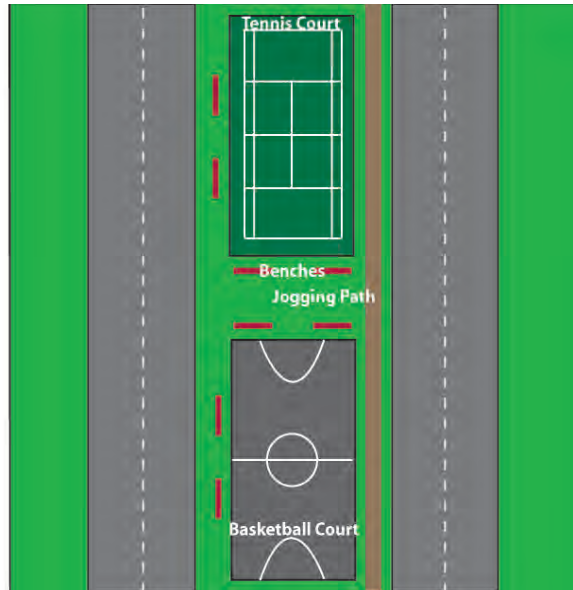

Concept for San Vicente Blvd.

Credit: Marty Bruinsma



Credit: Marty Bruinsma